



Dortrenk Turizm Gayr. Mot.Tas.San. ve Tic. Ltd.Şti.
Tax Administration & No:
Ikitelli / 313 058 5172
Adress :
Ikitelli O.S.B Dolapdere Sanayi Sitesi 12.Ada No:56
Basaksehir / Istanbul / Turkiye
Tel :+90 (212) 243 02 03 Fax: +90 (212) 355 02 42
Email: bilgi@otobusyedeckparca.com

01-2017

INTERNATIONAL MANUFACTURER SPARE PARTS / ULUSLARARASI YEDEK PARÇA İMALATI

PRODUCT CATALOGUE 2017



ISO 9001 : 2008

*BİR DORTRENK GROUP KURULUŞUDUR/ ALL RIGHT MANUFACTURES BELONGS TO THE DORTRENK GROUP
COMPANY









*ASSIST MARKASI DORTRENK GROUP'A AİTTİR../ ASSIST IS BRAND OF DORTRENK GROUP

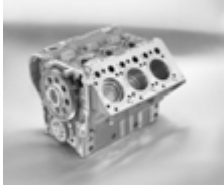

Dortrenk Turizm Gayr. Mot.Tas.San. ve Tic. Ltd.Şti.
Tax Administration & No:
Ikitelli / 313 058 5172
Address :
Ikitelli O.S.B Dolapdere Sanayi Sitesi 12.Ada No:56
Basaksehir / Istanbul / Turkiye
Tel :+90 (212) 243 02 03 Fax: +90 (212) 355 02 42
Email: bilgi@otobusyedekparca.com

01-2017

DESCRIPTION

	MERCEDES MAN MARATON SAFİR COBRA MARINE FORD	PAGE NO 4.104
	COMPRESSOR REPAIR KIT	105.146
	GEARBOX PTO FULL SET GASKET	147.162
	RETARDER REPAIR KIT O-RING GASKET	163.168
	TIGHTENER PULLEY VE TENSIONER BEARING	169.174
	OIL COOLER ADBLUE FILTER, ADBLUE PUMP RADIATOR COVER FİLTER MERCEDES.BENZ SCANIA.RENAULT VOLVO	175.180
	SHIRT TYRE WEATHER PRESSURE TUBE VALVE-EXHAUST BUTTERFLIES EXHAUST TUB FELT STEERING REPAIR KIT	181.188
	VENTILATION HOSES NUTS SENSOR SWITCH INTERCOL HOSES	189.198
	DAF SCANIA VOLVO REKOR DESCRIPTION	199.224



Dortrenk Turizm Gayr. Mot.Tas.San. ve Tic. Ltd.Şti.
Tax Administration & No:
Ikitelli / 313 058 5172
Adress :
Ikitelli O.S.B Dolapdere Sanayi Sitesi 12.Ada No:56
Basaksehir / Istanbul / Turkiye
Tel :+90 (212) 243 02 03 Fax: +90 (212) 355 02 42
Email: bilgi@otobusyedekparca.com

01-2017

(BALL) KOYOTO.YKS

FOR MERCEDES ENGINE

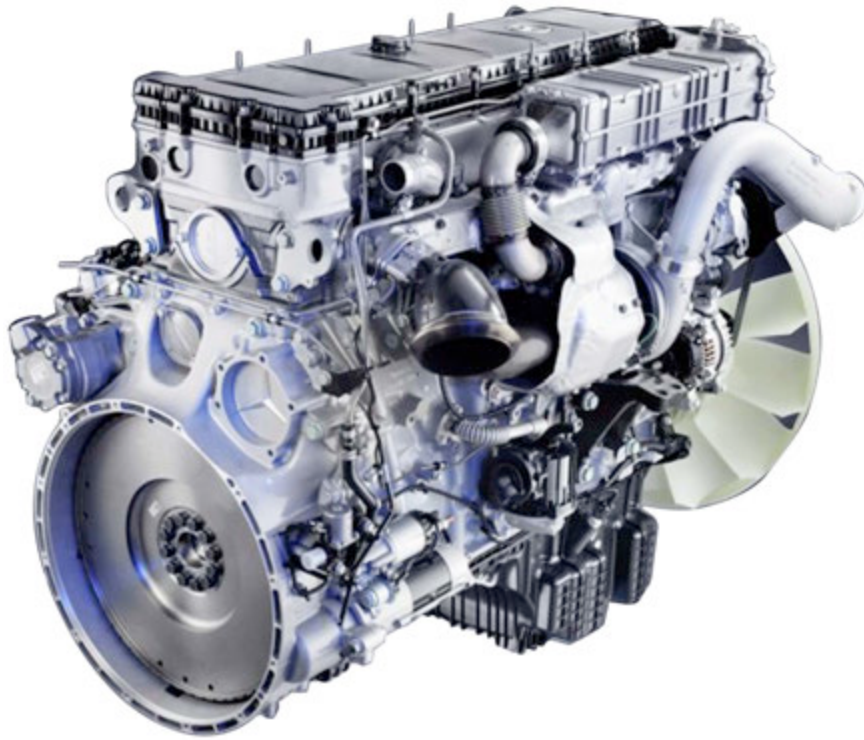

SECTION



Dortrenk Turizm Gayr. Mot.Tas.San. ve Tic. Ltd.Şti.
Tax Administration & No:
Ikitelli / 313 058 5172
Address :
Ikitelli O.S.B Dolapdere Sanayi Sitesi 12.Ada No:56
Basaksehir / Istanbul / Turkiye
Tel :+90 (212) 243 02 03 Fax: +90 (212) 355 02 42
Email: bilgi@otobusyedeckparca.com

01-2017

For Mercedes Benz		OM.309.314		
314.050	364.070	314.083	314.080	
314.088	314.090	366.010	352.011	
352.013	352.020	352.021	364.131	
355.160	314.160		352.190	352.201
352.202	366.203	302.210	364.210	302.260
314.101			314.060	
352.0260	366.8248	366.4141	352.0080	



Dortrenk Turizm Gayr. Mot.Tas.San. ve Tic. Ltd.Şti.

Tax Administration & No:

Ikitelli / 313 058 5172

Adress :

Ikitelli O.S.B Dolapdere Sanayi Sitesi 12.Ada No:56

Basaksehir / Istanbul / Turkiye

Tel :+90 (212) 243 02 03 Fax: +90 (212) 355 02 42

Email: bilgi@otobusyedekparca.com

01-2017





Dortrenk Turizm Gayr. Mot.Tas.San. ve Tic. Ltd.Şti.
Tax Administration & No:
 Ikitelli / 313 058 5172
Address :
 Ikitelli O.S.B Dolapdere Sanayi Sitesi 12.Ada No:56
 Basaksehir / Istanbul / Turkiye
Tel :+90 (212) 243 02 03 Fax: +90 (212) 355 02 42
Email: bilgi@otobusyedekparca.com











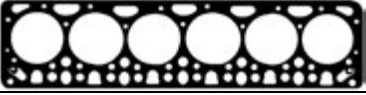











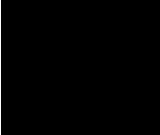



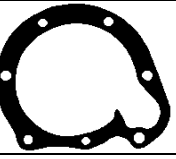

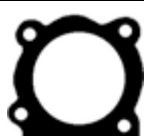
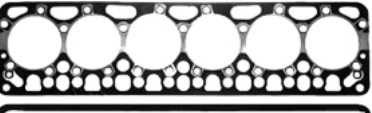

01-2017

For Mercedes		OM-309-314		
IMSP	Orj. Ref.	DESCRIPTION	Unit	
314.100	Elr. No:825.913	Full Set Gasket	Set.	
314.101	314 010 60 20	Cylinder Head Gasket	Set.	
314.102	314 010 81 08	Half Set Gasket	Set.	
314.104		Half Set Gasket (Rubber Stamp Set)	Set.	
314.050	364 016 07 20	Cylinder Cover Gasket	Pcs.	
314.060	364 010 11 80	Oil Pan Gasket-(1.Quality Unit)	Pcs.	
364.070	364 015 01 80	Oil Radiator Gasket	Pcs.	
314.080	314 016 03 21	Valve Cover Gasket-(2,mm / Wired)	Pcs.	
314.083	314 016 03 21	Valve Cover Gasket-(2,mm / Klingrit)	Pcs.	
314.090	314 015 06 22	Side Cover Gasket	Pcs.	
366.010	366 015 01 80	Eccentric Cover Gasket	Pcs.	
352.011	352 015 03 20	Eccentric Cover Gasket	Pcs.	
352.013	352 015 03 80	Flywheel Setting Gasket	Pcs.	
352.020	352 131 06 80	Compressor Gasket	Pcs.	
352.021	321 131 01 80	Compressor Gasket	Pcs.	
314.088	314 016 04 80	Suction Pipe Gasket	Pcs.	
364.131	364 201 02 80	Water Pump Gasket	Pcs.	
355.160	345 142 00 80	Exhaust Pipe Gasket	Pcs.	
314.160	314 142 03 80	Exhaust Manifold Gasket	Pcs.	
314.161	314 142 03 80	Exhaust Manifold Gasket (Storied)	Pcs.	
352.190	352 076 02 80	Fuel-Oil Pump Gasket	Pcs.	
352.201	352 203 23 80	Thermostat Gasket	Pcs.	
352.202	352 203 24 80	Thermostat Gasket	Pcs.	
366.203	366 203 03 80	Water Pipe Gasket	Pcs.	
302.210	364 184 01 80	Oil Filter Gasket	Pcs.	
364.210	364 184 02 80	Oil Filter Gasket	Pcs.	
302.260	366 203 20 80	Thermostat Gasket	Pcs.	
352.0080	352 078 00 80	Injektör Recycle Stamp	Pcs.	
352.0260	388 017 01 60	Injektör Stamp (1mm)	Pcs.	
366.8248	016 997 82 48	Holder Oring (30,8x38x3,7 FKM)	Pcs.	
366.4141	001 997 41 41	Gasket Seal	Pcs.	



Dortrenk Turizm Gayr. Mot.Tas.San. ve Tic. Ltd.Şti.
Tax Administration & No:
 Ikitelli / 313 058 5172
Adress :
 Ikitelli O.S.B Dolapdere Sanayi Sitesi 12.Ada No:56
 Basaksehir / Istanbul / Turkiye
Tel :+90 (212) 243 02 03 Fax: +90 (212) 355 02 42
Email: bilgi@otobusyedekparca.com

01-2017

For Mercedes.Benz		OM.352			
					
352.050		352.060		352.070	
					
352.071	352.083	352.080		366.010	
					
352.090	352.072	352.011	352.180	352.190	
					
352.020	352.021	366.068	352.013	314.088	352.131
					
364.131	352.160	352.170	302.210	364.210	302.260
					
		352.201	352.202	366.203	352.079
					
352.101	366.4141	352.0080	352.0260	366.8248	



Dortrenk Turizm Gayr. Mot.Tas.San. ve Tic. Ltd.Şti.
Tax Administration & No:
 Ikitelli / 313 058 5172
Address :
 Ikitelli O.S.B Dolapdere Sanayi Sitesi 12.Ada No:56
 Basaksehir / Istanbul / Turkiye
Tel :+90 (212) 243 02 03 Fax: +90 (212) 355 02 42
Email: bilgi@otobusyedekparca.com

01-2017

For Mercedes		OM-352		
IMSP	Orj. Ref.	DESCRIPTION	Unit	
352.100	Elr. No:826.871	Full set Gasket	Set.	
352.101	352 010 26 21	Cylinder Head Gasket	Set.	
352.101.1	352010 26 21	Cylinder Head Gasket (Orj.)	Set.	
352.102	353 010 47 08	Half Set Gasket	Set.	
352.104	353 010 47 08	Half Set Gasket (Rubber Stamp Set)	Set.	
352.050	366 016 06 20	Cylinder Cover Gasket	Pcs.	
352.060	366 010 06 80	Oil Pan Gasket	Pcs.	
352.070	352 180 25 65	Oil Radiator Set Gasket	Set.	
352.071	352 188 08 80	Oil Radiator Gasket	Pcs.	
352.072	366 188 02 80	Oil Radiator Gasket	Pcs.	
352.080	352 016 09 21	Valve Cover Gasket-(2,50 mm)	Pcs.	
352.083	352 016 09 21	Valve Cover Gasket (2,50 mm Wired)	Pcs.	
352.090	352 015 05 22	Side Cover Gasket	Pcs.	
366.010	366 015 01 80	Eccentric Inner Cover Gasket	Pcs.	
352.011	352 015 03 20	Eccentric Outer Cover Gasket	Pcs.	
352.013	352 015 03 80	Flywheel Setting Gasket	Pcs.	
352.020	352 131 06 80	Compressor Gasket	Pcs.	
352.021	321 131 01 79	Compressor Gasket	Pcs.	
366.068	366 018 02 80	Oil Pan Gasket	Pcs.	
352.079	102 018 03 80	Oil Cover Gasket	Pcs.	
314.088	314 016 04 80	Suction Pipe Gasket	Pcs.	
352.131	352 201 20 80	Water Pump Gasket	Pcs.	
364.131	364 201 02 80	Water Pump Gasket	Pcs.	
352.160	352 142 04 80	Exhaust Manifold Gasket	Pcs.	
352.161	352 142 04 80	Exhaust Manifold Gasket (Katlı)	Pcs.	
352.170	312 492 10 80	Exhaust Pipe Gasket	Pcs.	
352.180		Aks Front Cover Gasket	Pcs.	
352.190	352 076 02 80	Fuel-Oil Pump Gasket	Pcs.	
352.201	352 203 23 80	Thermostat Gasket	Pcs.	
352.202	352 203 24 80	Thermostat Gasket	Pcs.	
366.203	366 203 03 80	Water Pipe Gasket	Pcs.	
302.210	364 184 01 80	Oil Filter Gasket	Pcs.	
364.210	364 184 02 80	Oil Filter Gasket	Pcs.	
302.260	366 203 20 80	Thermostat Gasket	Pcs.	
352.0080	352 078 00 80	Injektör Recycle Stamp	Pcs.	
352.0260	388 017 01 60	Injektör Stamp (1mm)	Pcs.	
366.8248	016 997 82 48	Holder Oring (30,8x38x3,7 FKM)	Pcs.	
366.4141	001 997 41 41	Oil Seal	Pcs.	



Dortrenk Turizm Gayr. Mot.Tas.San. ve Tic. Ltd.Şti.
Tax Administration & No:
 İkitelli / 313 058 5172
Adress :
 İkitelli O.S.B Dolapdere Sanayi Sitesi 12.Ada No:56
 Basaksehir / İstanbul / Türkiye
Tel :+90 (212) 243 02 03 Fax: +90 (212) 355 02 42
Email: bilgi@otobusyedekparca.com

01-2017

For Mercedes.Benz		OM.346.355			
355.050		355.070	355.060		
355.051	355.160	355.150		355.090	
355.010	302.190	355.074	355.501	355.131	355.080
355.136	355.069	355.099	355.152	355.260	302.170
355.134	355.203	355.205	346.210	355.210	355.231
355.233	355.235	352.0080	352.0260	366.8248	



Dortrenk Turizm Gayr. Mot.Tas.San. ve Tic. Ltd.Şti.
Tax Administration & No:
 Ikitelli / 313 058 5172
Address :
 Ikitelli O.S.B Dolapdere Sanayi Sitesi 12.Ada No:56
 Basaksehir / Istanbul / Turkiye
Tel :+90 (212) 243 02 03 Fax: +90 (212) 355 02 42
Email: bilgi@otobusyedekparca.com

01-2017

For Mercedes		OM-346-355		
IMSP	Orj. Ref.	DESCRIPTION	Unit	
355.100	Elr. No:581.519	Full set Gasket	Set.	
355.101	355 010 12 20	Cylinder Head Gasket	Set.	
346.101	355 010 12 20	Cylinder Head Gasket	Set.	
355.102	355 010 55 08	Half Set Gasket	Set.	
355.104	355 010 55 08	Half Set Gasket (Rubber Stamp Set)	Set.	
355.050	355 016 04 20	Cylinder Cover Gasket (All)	Pcs.	
355.051	346 016 03 20	Cylinder Cover Gasket (Half)	Pcs.	
355.060	355 010 00 27	Oil Pan Gasket	Pcs.	
355.070	355 015 00 21	Side Cover Gasket	Pcs.	
355.080	355 016 00 21	Valve Cover Gasket	Pcs.	
355.090	355 015 01 22	Oil Radiator Gasket	Pcs.	
355.010	346 015 01 20	Eccentric Cover Gasket	Pcs.	
355.069	355 018 02 80	Oil Pan Gasket	Pcs.	
355.074	355 188 01 80	Oil Cooler Gasket	Pcs.	
355.099		Gasket	Pcs.	
355.131	355 201 06 80	Water Pump Gasket	Pcs.	
355.134	355 201 02 80	Water Pump Gasket	Pcs.	
355.136		Gasket	Pcs.	
355.150	355 141 02 80	Intake Manifold Gasket	Pcs.	
355.152	360 203 03 80	Intake Manifold Intermediate Rubber	Pcs.	
355.160	345 142 00 80	Exhaust Manifold Gasket	Pcs.	
302.170	355 141 03 80	Exhaust Throat Gasket	Pcs.	
302.190	355 077 00 80	Fuel-Oil Vacuum Gasket	Pcs.	
355.203	355 997 00 49	Water Pipe Gasket	Pcs.	
355.205		Gasket	Pcs.	
346.210		Gasket	Pcs.	
355.210	355 184 06 80	Gasket	Pcs.	
355.231		Gasket	Pcs.	
355.233		Gasket	Pcs.	
355.235		Gasket	Pcs.	
355.260		Thermostat Gasket	Pcs.	
352.0080	352 078 00 80	Injektör Recycle Stamp	Pcs.	
352.0260	388 017 01 60	Injektör Stamp (1mm)	Pcs.	
366.8248	016 997 82 48	Holder Oring (30,8x38x3,7 FKM)	Pcs.	
355.501	355 142 01 80	Turbo Gasket	Pcs.	



Dortrenk Turizm Gayr. Mot.Tas.San. ve Tic. Ltd.Şti.
Tax Administration & No:
 Ikitelli / 313 058 5172
Adress :
 Ikitelli O.S.B Dolapdere Sanayi Sitesi 12.Ada No:56
 Basaksehir / Istanbul / Turkiye
Tel :+90 (212) 243 02 03 Fax: +90 (212) 355 02 42
Email: bilgi@otobusyedekparca.com

01-2017

For Mercedes.Benz				OM.302.327.360 360A 360 H			
302.050		302.051		302.060			
302.070		302.080	302.090	302.100		302.010	
302.112	302.131	302.150	302.012	302.011			
302.020	302.021	302.031	302.160	302.180	302.190		
302.290	302.260	302.134	302.210	302.206	366.199	302.170	
352.0260	302.205	352.201	302.203	302.101		302.101.1	
366.8248	302.8248	352.202		302.101		302.101.1	



Dortrenk Turizm Gayr. Mot.Tas.San. ve Tic. Ltd.Şti.
Tax Administration & No:
 Ikitelli / 313 058 5172
Address :
 Ikitelli O.S.B Dolapdere Sanayi Sitesi 12.Ada No:56
 Basaksehir / Istanbul / Turkiye
Tel :+90 (212) 243 02 03 Fax: +90 (212) 355 02 42
Email: bilgi@otobusyedekparca.com

01-2017

For Mercedes		OM-302-327-360 360A 360 H		
IMSP	Orj. Ref.	DESCRIPTION	Unit	
302.100	360 010 03 44	Full Set Gasket	Set.	
302.101	360 010 33 20	Cylinder Head gasket	Set.	
302.101.1	360 010 33 20	Cylinder Head gasket	Set.	
302.102	360 010 55 08	Half Set Gasket	Set.	
302.050	360 016 03 20	Cylinder Gasket	Pcs.	
302.051	327 016 08 20	Cylinder Gasket	Pcs.	
302.060	360 014 03 22	Oil pan Gasket	Pcs.	
302.070	360 018 02 80	Oil Radiator Gasket	Pcs.	
302.080	360 016 02 21	Valve Cover Gasket	Pcs.	
302.083	360 016 02 21	Valve Cover Gasket (Klingrite)	Pcs.	
302.090	360 015 02 22	Side Cover Gasket	Pcs.	
302.010	360 015 04 80	Eccentric Inner Cover Gasket	Pcs.	
302.011	360 015 01 20	Eccentric Outer Cover Gasket	Pcs.	
302.012	360 015 03 80	Back Crankshaft Cover Gasket	Pcs.	
302.020		Compressor Gasket	Pcs.	
302.021		Compressor Gasket	Pcs.	
302.031		Compressor Gasket	Pcs.	
302.112		Flywheel Rear Gasket (EVA)	Pcs.	
302.131	360 201 03 80	Water Pump Gasket	Pcs.	
302.134	360 201 01 80	Water Pump Gasket	Pcs.	
302.140		Differential Gasket	Pcs.	
302.150	360 141 01 80	Intake Manifold Gasket	Pcs.	
302.160	360 142 03 80	Exhaust manifold Gasket	Pcs.	
302.161	360 142 03 80	Exhaust manifold Gasket-(Orj. Tip)	Pcs.	
302.170	355 141 03 80	Exhaust Throat Gasket	Pcs.	
302.180	943 334 00 80	AKS Cover Gasket (1,00mm)	Pcs.	
302.181		Aks Gasket (1,50mm)	Pcs.	
302.190	355 077 00 80	AKS Cover Gasket 1,50mm	Pcs.	
366.199	001 074 22 80	Fuel-Oil Vacuum Gasket	Pcs.	
302.200		Water Pipe Gasket Set	Set..	
352.201	352 203 23 80	Water Pipe Gasket	Pcs.	
352.202	352 203 24 80	Water Pipe Gasket	Pcs.	
302.203	360 203 00 80	Water Pipe Gasket	Pcs.	
302.205		Water Pipe Gasket	Pcs.	
302.206		Centrifugal Gasket	Pcs.	
302.210	364 184 01 80	Oil Filter Gasket	Pcs.	
302.260	352 203 20 80	Thermostat Gasket	Pcs.	
302.290		Steering Pump Gasket	Pcs.	
302.500		Powdered Felt	Pcs.	
302.8248		Fuel Return Stamp	Pcs.	
302.0080		Injektör Recycle Stamp	Pcs.	
352.0260	388 017 01 60	Injektör Stamp	Pcs.	
366.8248	016 997 82 48	Holder Oring (30,8x38x3,7 Green Viton)	Pcs.	



Dortrenk Turizm Gayr. Mot.Tas.San. ve Tic. Ltd.Şti.
Tax Administration & No:
 Ikitelli / 313 058 5172
Adress :
 Ikitelli O.S.B Dolapdere Sanayi Sitesi 12.Ada No:56
 Basaksehir / Istanbul / Turkiye
Tel :+90 (212) 243 02 03 Fax: +90 (212) 355 02 42
Email: bilgi@otobusyedekparca.com

01-2017

For Mercedes.Benz		OM.364 A / LA MB 800			
364.050		364.060		364.070	
364.080		364.083		364.090	
352.013	364.020	364.067	366.068	355.074	352.079
314.088	364.131	366.134	366.150	366.160	352.190
366.199	366.203	364.210	364.211	366.260	364.401
366.401	366.402	364.403	364.404	364.501	364.502
401.504	401.505	366.010	366.011		
352.0080	352.0260	366.8248	366.4141	364.101	



Dortrenk Turizm Gayr. Mot.Tas.San. ve Tic. Ltd.Şti.
Tax Administration & No:
 Ikitelli / 313 058 5172
Address :
 Ikitelli O.S.B Dolapdere Sanayi Sitesi 12.Ada No:56
 Basaksehir / Istanbul / Turkiye
Tel :+90 (212) 243 02 03 Fax: +90 (212) 355 02 42
Email: bilgi@otobusyedekparca.com

01-2017

For Mercedes		OM-364 A/LA MB 800		
IMSP	Orj. Ref.	DESCRIPTION	Unit	
364.100	Elr. No:825.825	Full set Gasket	Set.	
364.104		Half Set Gasket	Set.	
364.050	364 016 07 20	Cylinder Gasket	Pcs.	
364.060	364 010 11 80	Oil Pan Gasket (Orj.)	Pcs.	
364.070	364 015 01 80	Oil Radiator Gasket	Pcs.	
364.080	364 016 01 21	Valve Cover Gasket	Pcs.	
364.083	366 016 03 21	Valve Cover Gasket (Klingrite)	Pcs.	
364.090	364 015 03 60	Side Cover Gasket (ACM)	Pcs.	
366.010	366 015 01 80	Eccentric Inner Cover Gasket	Pcs.	
366.011	366 015 00 20	Eccentric Outer Cover Gasket	Pcs.	
352.013	352 015 03 80	Flywheel Rear Gasket	Pcs.	
364.020	366 131 02 80	Compressor Gasket	Pcs.	
364.067	001 074 22 80	Fuel-Oil Pump Gasket	Pcs.	
366.068	366 018 02 80	Oil Pan Gasket	Pcs.	
355.074	355 188 01 80	Oil Cooler Gasket	Pcs.	
352.079		Oil Cover Gasket	Pcs.	
314.088	314 016 04 80	Suction Pipe Gasket	Pcs.	
364.131	364 201 02 80	Water Pump Gasket	Pcs.	
366.134	366 201 03 80	Water Pump Gasket	Pcs.	
366.150	366 141 07 80	Intake Manifold Gasket	Pcs.	
366.160	366 142 08 80	Exhaust Manifold Gasket	Pcs.	
352.190	011 997 16 48	Steering Vacuum Gasket	Pcs.	
366.199	001 074 22 80	Filter Gasket	Pcs.	
366.203	366 203 03 80	Water Manifold Gasket	Pcs.	
364.210	364 184 01 80	Oil Filter Billet Gasket	Pcs.	
364.211		Gasket	Pcs.	
366.260	366 203 02 80	Thermostat Gasket	Pcs.	
364.401	366 098 15 80	Suction Throat Gasket	Pcs.	
366.401		Gasket	Pcs.	
366.402	364 184 03 80	Gasket	Pcs.	
364.403		Cooler Side Cover Gasket	Pcs.	
364.404		Oil Radiator Gasket	Pcs.	
364.500		Turbo Set Gasket	Pcs.	
364.501		Turbo Gasket (Rectangle)	Pcs.	
364.502		Turbo Gasket (Round)	Pcs.	
401.504	442 187 01 80	Turbo Gasket (Oil Small)	Pcs.	
401.505	442 187 00 80	Turbo Gasket (Oil Big)	Pcs.	
352.0080	352 078 00 80	Injektör Recycle Stamp	Pcs.	
352.0260	388 017 01 60	Injektör Stamp (1mm)	Pcs.	
366.8248	016 997 82 48	Holder Oring (30,8x38x3,7 Green Viton)	Pcs.	
366.4141	001 997 41 41	Seal	Pcs.	



Dortrenk Turizm Gayr. Mot.Tas.San. ve Tic. Ltd.Şti.
Tax Administration & No:
 Ikitelli / 313 058 5172
Adress :
 Ikitelli O.S.B Dolapdere Sanayi Sitesi 12.Ada No:56
 Basaksehir / Istanbul / Turkiye
Tel :+90 (212) 243 02 03 Fax: +90 (212) 355 02 42
Email: bilgi@otobusyedekparca.com

01-2017

For Mercedes.Benz		OM.366 25.17.25.21 366 A/LA			
366.050		366.060		366.070	
366.080		366.083		366.090	
352.013	366.020	366.068	355.074	364.131	366.131
366.134	366.150	366.160	366.170	366.180	352.190
366.199	366.203	302.210	366.210	366.260	366.261
364.401	366.401	364.402	401.406	366.501	366.502
401.504	401.505	366.010	366.011		
352.0080	352.0260	366.8248	366.4141		



Dortrenk Turizm Gayr. Mot.Tas.San. ve Tic. Ltd.Şti.
Tax Administration & No:
 Ikitelli / 313 058 5172
Address :
 Ikitelli O.S.B Dolapdere Sanayi Sitesi 12.Ada No:56
 Basaksehir / Istanbul / Turkiye
Tel :+90 (212) 243 02 03 Fax: +90 (212) 355 02 42
Email: bilgi@otobusyedekparca.com

01-2017

For Mercedes		OM-366 25.17-25.21 366 A/LA		
IMSP	Orj. Ref.	DESCRIPTION	Unit	
366.100	Elr. No:826.783	Full Set Gasket (Orj.)	Set.	
366.101	366 010 61 20	Cylinder Head gasket	Set.	
366.104		Half Set Gasket (Rubber/Stamp)	Set.	
366.105	Elr. No:826.783	Full Set Gasket (Cylinder Cover Excluded)	Set.	
366.050	366 016 06 20	Cylinder Gasket	Pcs.	
366.060	366 010 06 80	Oil Pan Gasket	Pcs.	
366.070	366 188 05 80	Oil Radiator Gasket	Pcs.	
366.080	366 016 03 21	Valve cover Gasket-(2,5 mm)	Pcs.	
366.083	366 016 03 21	Valve cover Gasket-(2.mm)	Pcs.	
366.084	366 016 03 21	Valve cover Gasket-(3.mm)	Pcs.	
366.090	366 015 00 60	Side Cover Gasket Rubber	Pcs.	
366.010	366 015 01 80	Eccentric Inner Cover Gasket	Pcs.	
366.011	366 015 00 20	Eccentric Outer Cover Gasket	Pcs.	
352.013	352 015 03 80	Flywheel Ventilation Gasket	Pcs.	
366.020	366 131 02 80	Compressor Gasket	Pcs.	
366.068	366 018 02 80	Oil Pan Gasket	Pcs.	
355.074	355 188 01 80	Gasket	Pcs.	
366.130		Water Pump Gasket Seti	Set.	
364.131	364 201 02 80	Water Pump Gasket	Pcs.	
366.131	366 201 04 80	Water Pump Gasket	Pcs.	
366.134	366 201 03 80	Water Pump Gasket	Pcs.	
366.150	366 141 07 80	Intake Manifold Gasket	Pcs.	
366.160	366 142 08 80	Exhaust Manifold Gasket	Pcs.	
366.170		Exhaust Throat Gasket	Pcs.	
366.180	650 356 00 80	AKS Cover Gasket	Pcs.	
352.190	014 997 61 48	Steering Vacuum Gasket	Pcs.	
366.199	001 074 22 80	Fuel-Oil Filter Gasket	Pcs.	
366.203	366 203 03 80	Water Manifold Gasket	Pcs.	
302.210	364 184 01 80	Oil Filter Gasket	Pcs.	
366.210	366 184 02 80	Oil Filter Gasket	Pcs.	
366.260	366 203 02 80	Thermostat Gasket	Pcs.	
366.261	366 203 02 80	Thermostat Gasket	Pcs.	
364.401		Suction Throat Gasket	Pcs.	
366.401		Gasket	Pcs.	
364.402	364 184 03 80	Oil Radiator Water Pipe Gasket	Pcs.	
401.406		Oil Radiator Cooler Gasket	Pcs.	
366.500		Turbo Gasket Set	Set.	
366.501	366 142 01 80	Turbo Gasket (Rectangle)	Pcs.	
366.502	366 144 02 80	Turbo Gasket (Round)	Pcs.	
401.504	442 187 01 80	Turbo Gasket (Oil Small)	Pcs.	
401.505	442 187 00 80	Turbo Gasket (Oil Big)s	Pcs.	
352.0080	352 078 00 80	Injektör Recycle Stamp	Pcs.	
352.0260	388 017 01 60	Injektör Stamp (1mm)	Pcs.	
366.8248	016 997 82 48	Holder Oring (30,8x38x3,7 Green Viton)	Pcs.	
366.4141	001 997 41 41	Seal	Pcs.	



Dortrenk Turizm Gayr. Mot.Tas.San. ve Tic. Ltd.Şti.
Tax Administration & No:
 Ikitelli / 313 058 5172
Adress :
 Ikitelli O.S.B Dolapdere Sanayi Sitesi 12.Ada No:56
 Basaksehir / Istanbul / Turkiye
Tel :+90 (212) 243 02 03 Fax: +90 (212) 355 02 42
Email: bilgi@otobusyedekparca.com

01-2017

For Mercedes Benz		OM.401.421 V/6 NOT TURBO			
421.050 Ø128	442.050 Ø128	442.101 Ø128	421.101 Ø128		421.070
401.060	441.070	401.010	401.131		401.112
401.081	401.791	401.260	352.180		401.180
402.155	441.155	421.150	401.160	302.170 (Ø77)	401.170 (Ø88)
401.013	401.414	401.501	401.502	401.504	401.505
402.134	401.134	401.403	401.404	401.405	401.406
401.413	421.079				



Dortrenk Turizm Gayr. Mot.Tas.San. ve Tic. Ltd.Şti.
Tax Administration & No:
 Ikitelli / 313 058 5172
Address :
 Ikitelli O.S.B Dolapdere Sanayi Sitesi 12.Ada No:56
 Basaksehir / Istanbul / Turkiye
Tel :+90 (212) 243 02 03 Fax: +90 (212) 355 02 42
Email:bilgi@otobusyedekparca.com

01-2017

For Mercedes Benz		OM-401-421 V/6 NOT TURBO		
IMSP	Orj. Ref.	DESCRIPTION	Unit	
421.100	EK: 826.502	V/6 Full Set Gasket (128Ø)	Set.	
421.100.1	EK: 826.502	V/6 Full Set Gasket (128Ø orj skc)	Set.	
401.101	444 010 01 20	Cylinder Head Gasket-(125Ø)	Set.	
421.101	444 010 01 20	Cylinder Head Gasket-(128Ø)	Set.	
441.101	444 010 01 20	Cylinder Head Gasket-(125Ø Rubber)	Set.	
442.101	444 010 01 20	Cylinder Head Gasket-(128Ø Rubber)	Set.	
401-102	421 010 04 08	Half Set Gasket	Set.	
401.104		Half Set Gasket (Rubber/Stamp)	Set.	
401.105	EK: 826.502	Full SetGasket (Cylinder Cover Excluded)	Set.	
401.050		Cylinder Gasket-(125Ø)	Pcs.	
421.050	EK 748.080	Cylinder Gasket-(128Ø)	Pcs.	
441.050	442 016 04 20	Cylinder Gasket-(125Ø Rubber) elring no:412.180	Pcs.	
442.050	442 016 06 20	Cylinder Gasket-(128Ø Rubber) elring no:896.510	Pcs.	
401.060	441 014 00 22	Oil Pan Gasket V/6	Pcs.	
421.070	442 188 05 80	Oil Radiator Gasket (Silicone)	Pcs.	
441.070		Oil Radiator Gasket (Silicone)	Pcs.	
421.079		Gasket	Pcs.	
401.080	442 016 06 21	Valve cover Gasket - (NBR)	Pcs.	
401.081	442 016 06 21	Valve cover Gasket-(1,50 mm)	Pcs.	
401.082	442 016 06 21	Valve Cover Gasket (1,50mm Double Silicone)	Pcs.	
401.083	442 016 06 21	Valve Cover Gasket (2,50mm Not Silicone)	Pcs.	
401.084	442 016 06 21	Valve Cover Gasket (2,50mm Single Silicone)	Pcs.	
401.085	442 016 06 21	Valve Cover Gasket (2,50mm Double Silicone)	Pcs.	
401.010	442 011 00 80	Eccentric Cover Gasket	Pcs.	
401.010-2	442 011 00 80	Eccentric Cover Gasket	Pcs.	
401.013	407 015 03 80	Flywheel Ventilation Gasket	Pcs.	
401.112	442 015 01 80	Flywheel Rear Gasket Set	Pcs.	
401.131	442 201 10 80	Water Pump Gasket	Pcs.	
401.134	442 201 04 80	Camel Neck Gasket	Pcs.	
401.134.2	442 201 04 80	Gasket (Wired)	Pcs.	
402.134		Camel Neck Gasket	Pcs.	
401.150	442 141 17 80	Intake Manifold Gasket	Pcs.	
421.150	442 141 09 80	Intake Manifold Gasket	Pcs.	
402.155	442 141 07 80	Suction Pipe Gasket (Klingrite)	Pcs.	
402.155.2	442 141 07 80	Suction Pipe Gasket (Wired)	Pcs.	
441.155	442 112 07 80	Suction Pipe Gasket	Pcs.	
401.160	403 142 03 80	Exhaust Manifold Gasket	Pcs.	
302.170	355 141 03 80	Exhaust Throat Gasket (78Ø)	Pcs.	
401.170	442 492 00 80	Exhaust Throat Gasket (88Ø)	Pcs.	
352.180		AKS Front Cover Gasket	Pcs.	
401.180		AKS Back Cover Gasket	Pcs.	
401.260		Thermostat Gasket	Pcs.	
401.403	442 188 05 80	Oil Pan Gasket	Pcs.	
401.404		Gasket	Pcs.	
401.405	917003036003	Retarder Water Pipe Gasket V/8 403	Pcs.	
401.406	917003266003	Oil Cooler Gasket	Pcs.	
401.413		Oil Pan Gasket	Pcs.	
401.414		Gasket	Pcs.	
401.501	421 142 01 80	Turbo Gasket (Square)	Pcs.	
401.502	427 144 01 80	Turbo Gasket 3031-403-442 (Round)	Pcs.	
401.504	442 187 01 80	Turbo Gasket (Oil Small)	Pcs.	



Dortrenk Turizm Gayr. Mot.Tas.San. ve Tic. Ltd.Şti.

Tax Administration & No:

Ikitelli / 313 058 5172

Adress :

Ikitelli O.S.B Dolapdere Sanayi Sitesi 12.Ada No:56

Basaksehir / Istanbul / Turkiye

Tel :+90 (212) 243 02 03 Fax: +90 (212) 355 02 42

Email: bilgi@otobusyedekparca.com

01-2017

401.505	442 187 00 80	Turbo Gasket (Oil Big)	Pcs.	
441.506	422 997 00 40	Turbo O-rin	Pcs.	
401.791	442 015 00 60	Rubber Gasket	Pcs.	



Dortrenk Turizm Gayr. Mot.Tas.San. ve Tic. Ltd.Şti.
Tax Administration & No:
 Ikitelli / 313 058 5172
Adress :
 Ikitelli O.S.B Dolapdere Sanayi Sitesi 12.Ada No:56
 Basaksehir / Istanbul / Turkiye
Tel :+90 (212) 243 02 03 Fax: +90 (212) 355 02 42
Email: bilgi@otobusyedekparca.com

01-2017

For Mercedes Benz		OM.402.422 V/8 - L/LA			
421.050 Ø128	442.050 Ø128	442.101 Ø128	421.101 Ø128		421.070
402.060	441.070	401.010	401.131		401.112
401.081	401.791	441.451	442.451	352.180	401.180
401.260	402.134	401.134	401.414	401.013	401.403
402.155	441.155	421.150	401.160	302.170 (Ø77)	401.170 (Ø88)
401.406	401.413	401.501	401.502	401.504	401.505
401.404	401.405	401.490	421.079	402.603	



Dortrenk Turizm Gayr. Mot.Tas.San. ve Tic. Ltd.Şti.
Tax Administration & No:
 Ikitelli / 313 058 5172
Address :
 Ikitelli O.S.B Dolapdere Sanayi Sitesi 12.Ada No:56
 Basaksehir / Istanbul / Turkiye
Tel :+90 (212) 243 02 03 Fax: +90 (212) 355 02 42
Email: bilgi@otobusyedekparca.com

01-2017

For Mercedes Benz		OM.402.422 V/8 - L/LA	
IMSP	Orj. Ref.	DESCRIPTION	Unit
402.100	Elr. No:826.561	Full Set Gasket- (128.Ø V/8)	Set.
402.100.1		Full Set Gasket (Ø128 Orj Skc + Orj. Felt Not Turbo V/8)	Set.
401.101	444 010 01 20	Cylinder Head Gasket-(125Ø)	Set.
421.101	444 010 01 20	Cylinder Head Gasket-(128Ø)	Set.
441.101	444 010 01 20	Cylinder Head Gasket-(125Ø Rubber)	Set.
442.101	444 010 01 20	Cylinder Head Gasket-(128Ø Rubber)	Set.
402-102		Half Set Gasket	Set.
402.104		Half Set Gasket (Rubber Stamp)	Set.
442.104		Half Set Gasket (Rubber Stamp Skc and Not Felt OM.403)	Set.
402.105	EK: 914.975	Full Set Gasket (Cylinder Cover Excluded)	Set.
441.050	442 016 04 20	Cylinder Gasket (125Ø Rubber) elring no:412.180	Pcs.
442.050	442 016 06 20	Cylinder Gasket (128Ø Rubber) elring no:896.510	Pcs.
402.060	442 014 02 22	Oil Pan Gasket V/8	Pcs.
421.070	442 188 05 80	Oil Radiator Gasket (Silicone)	Pcs.
441.070		Oil Radiator Gasket (Silicone)	Pcs.
421.079		Oil Cooler Gasket (Aluminum)	Pcs.
401.080	442 016 06 21	Valve Cover Gasket NBR	Pcs.
401.081	442 016 06 21	Valve Cover Gasket (1,50 mm Single Silicone)	Pcs.
401.082	442 016 06 21	Valve Cover Gasket (1,50mm Double Silicone)	Pcs.
401.083	442 016 06 21	Valve Cover Gasket (2,50mm Not Silicone)	Pcs.
401.084	442 016 06 21	Valve Cover Gasket (2,50mm Single Silicone)	Pcs.
401.085	442 016 06 21	Valve Cover Gasket (2,50mm Double Silicone)	Pcs.
401.010	442 011 00 80	Eccentric Cover Gasket	Pcs.
401.010-2	442 011 00 80	Eccentric Cover Gasket (Wired)	Pcs.
401.013	407 015 03 80	Flywheel Ventilation Gasket	Pcs.
401.112	442 015 01 80	Flywheel Rear Gasket Set	Pcs.
401.131	442 201 10 80	Water Pump Gasket	Pcs.
401.134	442 201 04 80	Camel Neck Gasket	Pcs.
401.134.2	442 201 04 80	Camel Neck Gasket (Wired)	Pcs.
402.134	442 201 03 80	Camel Neck Gasket	Pcs.
401.150	442 141 17 80	Intake Manifold Gasket	Pcs.
421.150	442 141 09 80	Intake Manifold Gasket (Aluminum)	Pcs.
402.155	442 141 07 80	Suction Pipe Gasket (Klingrite)	Pcs.
402.155.2	442 141 07 80	Suction Pipe Gasket (Wired)	Pcs.
441.155	442 112 07 80	Suction Pipe Gasket (Wired)	Pcs.
401.160	403 142 03 80	Exhaust Manifold Gasket	Pcs.
302.170	355 141 03 80	Exhaust Throat Gasket-(78Ø)	Pcs.
401.170	442 492 00 80	Exhaust Throat Gasket-(88Ø)	Pcs.
352.180		AKS Front Gasket	Pcs.
401.180		AKS BackGasket	Pcs.
401.260		Thermostat Gasket	Pcs.
401.403	442 188 05 80	Oil Pan Gasket	Pcs.
401.404		Gasket	Pcs.
401.405	917003036003	V/8 403 Retarder Gasket	Pcs.
401.406	917003266003	Oil Cooler Gasket	Pcs.
401.413	355 997 01 49	Oil Pan Gasket	Pcs.
401.414		Gasket	Pcs.
401.490		Intecol Gasket (2,5 mm Klingrite)	Pcs.
401.490.2		Intecol Conta (2,5 mm Wired)	Pcs.
401.501	421 142 01 80	Turbo Gasket (Square)	Pcs.
401.502	427 144 01 80	Turbo Gasket 3031-403-442 (Round)	Pcs.
401.504	442 187 01 80	Turbo Gasket (Oil Small)	Pcs.
401.505	442 187 00 80	Turbo Gasket (Oil Big)	Pcs.
402.603	442 074 00 59	Pump Pipe Rubber	Pcs.



Dortrenk Turizm Gayr. Mot.Tas.San. ve Tic. Ltd.Şti.

Tax Administration & No:

Ikitelli / 313 058 5172

Adress :

Ikitelli O.S.B Dolapdere Sanayi Sitesi 12.Ada No:56

Basaksehir / Istanbul / Turkiye

Tel :+90 (212) 243 02 03 Fax: +90 (212) 355 02 42

Email: bilgi@otobusyedekparca.com

01-2017

401.791	442 015 00 60	Rubber Gasket	Pcs.	
---------	---------------	---------------	------	--



Dortrenk Turizm Gayr. Mot.Tas.San. ve Tic. Ltd.Şti.
Tax Administration & No:
 Ikitelli / 313 058 5172
Adress :
 Ikitelli O.S.B Dolapdere Sanayi Sitesi 12.Ada No:56
 Basaksehir / Istanbul / Turkiye
Tel :+90 (212) 243 02 03 Fax: +90 (212) 355 02 42
Email: bilgi@otobusyedekparca.com

01-2017

For Mercedes Benz			OM.441.304.30.31.30.26 V/6		
421.050 Ø128	442.050 Ø128		442.101 Ø128	421.101 Ø128	421.070
401.060	441.070		401.010	401.131	401.112
401.081	401.791		401.490	352.180	401.180
402.155	441.155	421.150	401.160	442.501	441.502
401.417	421.079	441.603	441.506	401.504	401.505
401.260	401.134	402.134	401.414	401.013	
401.403	401.406	401.413	401.405	401.404	



Dortrenk Turizm Gayr. Mot.Tas.San. ve Tic. Ltd.Şti.
Tax Administration & No:
 Ikitelli / 313 058 5172
Address :
 Ikitelli O.S.B Dolapdere Sanayi Sitesi 12.Ada No:56
 Basaksehir / Istanbul / Turkiye
Tel :+90 (212) 243 02 03 Fax: +90 (212) 355 02 42
Email:bilgi@otobusyedekparca.com

01-2017

For Mercedes Benz		OM-441-304-30.31-30.26		
IMSP	Orj. Ref.	DESCRIPTION	Unit	
441.100	EK: 914 959	3031-Full Set Gasket (128.Ø Rubber)	Set.	
441.100.1	EK: 914 959	3031 Full Set Gasket (Ø128 Rubber Orj. Skc + Orj Felt)	Set.	
442.101	444 010 01 20	Cylinder Head Gasket (128.Ø Rubber)	Set.	
441.102		Half Set Gasket	Set.	
441.104	421 010 04 08	Half Set Gasket (Rubber Stamp)	Set.	
441-105	EK: 914.595	Full Set Gasket (Cylinder Cover Excluded)	Set.	
441.050	442 016 04 20	Cylinder Gasket-(125Ø Rubber) elring no:412.180	Pcs.	
442.050	442 016 06 20	Cylinder Gasket-(128Ø Rubber) elring no:896.510	Pcs.	
401.060	441 014 00 22	Oil Pan Gasket V/6	Pcs.	
421.070	442 188 05 80	Oil Radiator Gasket (Silicone)	Pcs.	
441.070		Oil Radiator Gasket (Silicone)	Pcs.	
421.079		Oil Cooler Gasket (Aluminum)	Pcs.	
401.080	442 016 06 21	Valve Cover Gasket-(NBR)	Pcs.	
401.081	442 016 06 21	Valve Cover Gasket-(1,50 mm Single Silicone)	Pcs.	
401.082	442 016 06 21	Valve Cover Gasket (1,50mm Double Silicone)	Pcs.	
401.083	442 016 06 21	Valve Cover Gasket (2,50mm Not Silicone)	Pcs.	
401.084	442 016 06 21	Valve Cover Gasket (2,50mm Single Silicone)	Pcs.	
401.085	442 016 06 21	Valve Cover Gasket (2,50mm Double Silicone)	Pcs.	
401.010	442 011 00 80	Eccentric Cover Gasket	Pcs.	
401.010.2	442 011 00 80	Eccentric Cover Gasket (Wired)	Pcs.	
401.013	407 015 03 80	Flywheel Ventilation Gasket	Pcs.	
401.112	442 015 01 80	Flywheel Rear Gasket Set	Pcs.	
401.131	442 201 10 80	Water Pump Gasket	Pcs.	
401.134	442 201 04 80	Camel Neck Gasket	Pcs.	
401.134.2	442 201 04 80	Camel Neck Gasket (Wired)	Pcs.	
402.134	442 201 03 80	Camel Neck Gasket	Pcs.	
401.150	442 141 17 80	Intake Manifold Gasket	Pcs.	
421.150	442 141 09 80	Intake Manifold Gasket (Aluminum)	Pcs.	
402.155	442 141 07 80	Suction Pipe Gasket (Klingrite)	Pcs.	
402.155.2	442 141 07 80	Suction Pipe Gasket (Wired)	Pcs.	
441.155	442 112 07 80	Suction Pipe Gasket	Pcs.	
401.160	403 142 03 80	Exhaust Manifold Gasket	Pcs.	
352.180		AKS Front Gasket	Pcs.	
401.180		AKS Back Gasket	Pcs.	
401.260		Thermostat Gasket	Pcs.	
401.403	442 188 05 80	Cylinder Oil Reservoir Gasket	Pcs.	
401.404		Gasket	Pcs.	
401.405	917003036003	V/8 403 Retarder Gasket	Pcs.	
401.406	917003266003	Oil Cooler Gasket	Pcs.	
401.413		Cylinder Side Gasket	Pcs.	
401.414		Gasket	Pcs.	
401.417		Gasket	Pcs.	
401.490		Intercol Gasket (2,50 mm Klingrite)	Pcs.	
401.490.2		Intercok Gasket (2,50 mm Wired)	Pcs.	
441.501	421 142 01 80	Turbo Gasket (Square)	Pcs.	
441.502	427 144 01 80	Turbo Gasket 441-442 LA 3031 (Round)	Pcs.	
401.504	442 187 01 80	Turbo Gasket (Small)	Pcs.	
401.505	442 187 00 80	Turbo Gasket (Big)	Pcs.	
441.506	422 997 00 40	Turbo O-ring	Pcs.	
441.603	021 997 52 48	Turbo O-ring-(58 x 68 x8-3031)	Pcs.	
401.791	442 015 00 60	Rubber Gasket	Pcs.	



Dortrenk Turizm Gayr. Mot.Tas.San. ve Tic. Ltd.Şti.
Tax Administration & No:
 Ikitelli / 313 058 5172
Address :
 Ikitelli O.S.B Dolapdere Sanayi Sitesi 12.Ada No:56
 Basaksehir / Istanbul / Turkiye
Tel :+90 (212) 243 02 03 Fax: +90 (212) 355 02 42
Email: bilgi@otobusyedekparca.com

01-2017

For Mercedes Benz			OM.442.403 V/8 TURBO		
421.050 Ø128	442.050 Ø128		421.101 Ø128		421.070
402.060	441.070	401.010	401.131		401.112
401.081	401.791	401.490	442.451	352.180	401.180
401.260	401.134	402.134	401.414	401.418	401.013
402.155	441.155	442.154	441.159	421.150	401.160
442.501	441.502	442.603	441.506	401.504	401.505
401.406	401.413	401.416	401.450	421.079	402.603
401.403	401.405	401.404			



Dortrenk Turizm Gayr. Mot.Tas.San. ve Tic. Ltd.Şti.
Tax Administration & No:
 Ikitelli / 313 058 5172
Address :
 Ikitelli O.S.B Dolapdere Sanayi Sitesi 12.Ada No:56
 Basaksehir / Istanbul / Turkiye
Tel :+90 (212) 243 02 03 Fax: +90 (212) 355 02 42
Email:bilgi@otobusyedekparca.com

01-2017

For Mercedes Benz		OM-442-403 V/8 LA TURBO		
IMSP	Orj. Ref.	DESCRIPTION	Unit	
442.100	Elr. No:914.975	Full Tak Gasket- (128.Ø)	Set.	
442.100-1	Elr. No:914.975	Full Tak Gasket- (128.Ø)	Set.	
442.101	444 010 01 20	Cylinder Head Gasket-(128.Ø	Set.	
442.102		Half Set Gasket	Set.	
442.104		Half Set Gasket (Rubber Stamp)	Set.	
442.105	EK: 914.975	Full Set Gasket (Cylinder Cover Excluded)	Set.	
441.050	442 016 04 20	Cylinder Gasket (125Ø Rubber) elring no:412.180	Pcs.	
442.050	442 016 06 20	Cylinder Gasket (128Ø Rubber) elring no:896.510	Pcs.	
402.060	442 014 02 22	Oil Pan Gasket V/8	Pcs.	
421.070	442 188 05 80	Oil Radiator Gasket (Silicone)	Pcs.	
441.070		Oil Radiator Gasket (Silicone)	Pcs.	
421.079		Oil Cooler Gasket (Aluminum)	Pcs.	
401.080	442 016 06 21	Valve Cover Gasket-(NBR)	Pcs.	
401.081	442 016 06 21	Valve Cover Gasket (1,50 mm Single Silicone)	Pcs.	
401.082	442 016 06 21	Valve Cover Gasket (1,50mm Double Silicone)	Pcs.	
401.083	442 016 06 21	Valve Cover Gasket (2,50mm Not Silicone)	Pcs.	
401.084	442 016 06 21	Valve Cover Gasket (2,50mm Single Silicone)	Pcs.	
401.085	442 016 06 21	Valve Cover Gasket (2,50mm Double Silicone)	Pcs.	
401.010	442 011 00 80	Eccentric Cover Gasket	Pcs.	
401.010.2	442 011 00 80	Eccentric Cover Gasket (Wired)	Pcs.	
401.013	407 015 03 80	Flywheel Ventilation Gasket	Pcs.	
401.112	442 015 01 80	Flywheel Ventilation Gasket	Pcs.	
401.131	442 201 10 80	Water Pump Gasket	Pcs.	
401.134	442 201 04 80	Camel Neck Gasket	Pcs.	
401.134.2	442 201 04 80	Camel Neck Gasket (Wired)	Pcs.	
402.134	442 201 03 80	Camel Neck Gasket	Pcs.	
401.150	442 141 17 80	Intake Manifold Gasket	Pcs.	
421.150	442 141 09 80	Intake Manifold Gasket (Aluminum)	Pcs.	
402.155	442 141 07 80	Suction Pipe Gasket (Klingrite)	Pcs.	
402.155.2	442 141 07 80	Suction Pipe Gasket (Wired)	Pcs.	
441.155	442 112 07 80	Suction Pipe Gasket	Pcs.	
442.154		Suction Aluminum Gasket	Pcs.	
401.159		Suction Exit Gasket (Aluminum) 403 LA	Pcs.	
401.160	403 142 03 80	Exhaust Manifold Gasket	Pcs.	
352.180		AKS Front Cover Gasket	Pcs.	
401.180		AKS Back Cover Gasket	Pcs.	
401.260		Thermostat Gasket	Pcs.	
401.403	442 188 05 80	Oil Pan Gasket	Pcs.	
401.404		Gasket	Pcs.	
401.405	917003036003	V/8 403 Retarder Gasket	Pcs.	
401.406	917003266003	Oil Cooler Gasket	Pcs.	
401.413	355 997 01 49	Oil Pan Gasket	Pcs.	
401.414		Gasket	Pcs.	
401.416	67-2178-10	Gasket	Pcs.	
401.418		Suction Top Gasket	Pcs.	
401.450		Gear Tower Gasket	Pcs.	
401.490		Intercol Gasket (2,50mm Klingrite)	Pcs.	
401.490.2		Intercol Gasket (2,50mm Wired)	Pcs.	
441.501	421 142 01 80	Turbo Gasket	Pcs.	
441.502	427 144 01 80	Turbo Gasket 441-442 LA 3031	Pcs.	
401.504	442 187 01 80	Turbo Gasket	Pcs.	
401.505	442 187 00 80	Turbo Gasket	Pcs.	
441.506	422 997 00 40	Turbo O-ring	Pcs.	
442.603	006 997 48 48	Turbo O-ring (OM 403 Blue Silicone)	Pcs.	



Dortrenk Turizm Gayr. Mot.Tas.San. ve Tic. Ltd.Şti.

Tax Administration & No:

Ikitelli / 313 058 5172

Adress :

Ikitelli O.S.B Dolapdere Sanayi Sitesi 12.Ada No:56

Basaksehir / Istanbul / Turkiye

Tel :+90 (212) 243 02 03 Fax: +90 (212) 355 02 42

Email: bilgi@otobusyedekparca.com

01-2017

402.603	442 074 00 59	Pump Rubber	Pcs.	
401.791	442 015 00 60	Rubber Gasket Acm	Pcs.	



Dortrenk Turizm Gayr. Mot.Tas.San. ve Tic. Ltd.Şti.
Tax Administration & No:
 Ikitelli / 313 058 5172
Adress :
 Ikitelli O.S.B Dolapdere Sanayi Sitesi 12.Ada No:56
 Basaksehir / Istanbul / Turkiye
Tel :+90 (212) 243 02 03 Fax: +90 (212) 355 02 42
Email: bilgi@otobusyedekparca.com

01-2017

For Mercedes.Benz		OM.443 LA V/10			
421.050 Ø128	442.050 Ø128	442.101 Ø128	421.101 Ø128	421.070	
403.060	441.070	401.010	401.131	401.112	
401.081	401.791	401.490	402.603	352.180	401.180
401.260	401.134	402.134	401.414	401.013	401.413
402.155	441.155	421.150	401.160	401.501	401.502
401.403	401.406	401.504	401.505	442.603	441.506
421.079	401.404	401.405			



Dortrenk Turizm Gayr. Mot.Tas.San. ve Tic. Ltd.Şti.
Tax Administration & No:
 Ikitelli / 313 058 5172
Address :
 Ikitelli O.S.B Dolapdere Sanayi Sitesi 12.Ada No:56
 Basaksehir / Istanbul / Turkiye
Tel :+90 (212) 243 02 03 Fax: +90 (212) 355 02 42
Email: bilgi@otobusyedekparca.com

01-2017

For Mercedes Benz		OM-443 LA 128.Ø V/10 TURBO		
IMSP	Orj. Ref.	DESCRIPTION	Unit	
443.100	EK:826.669	Full Set Gasket (128.Ø) LA	Set.	
443.100.1	EK:826.669	Full Set Gasket (128.Ø Orj.LA)	Set.	
442.101	444 010 01 20	Cylinder Head Gasket (128.Ø Rubber)	Set.	
443.102		Half Set Gasket	Set.	
443.104		Half Set Gasket (Rubber Stamp)	Set.	
443.105		Full Set Gasket (Cylinder Cover Excluded)	Set.	
441.050	442 016 04 20	Cylinder Gasket (125Ø Rubber) elring no:412.180	Pcs.	
442.050	442 016 06 20	Cylinder Gasket (128Ø Rubber) elring no:896.510	Pcs.	
403.060	443 014 00 22	Oil Pan Gasket V/10	Pcs.	
421.070	442 188 05 80	Oil Radiator Gasket (Silicone)	Pcs.	
441.070		Oil Radiator Gasket (Silicone)	Pcs.	
421.079		Oil Radiator Gasket (Aluminum)	Pcs.	
401.080	442 016 06 21	Valve Cover Gasket-(NBR)	Pcs.	
401.081	442 016 06 21	Valve Cover Gasket-(1,50 mm)	Pcs.	
401.082	442 016 06 21	Valve Cover Gasket (1,50mm Double Silicone)	Pcs.	
401.083	442 016 06 21	Valve Cover Gasket (2,50mm Not Silicone)	Pcs.	
401.084	442 016 06 21	Valve Cover Gasket (2,50mm Single Silicone)	Pcs.	
401.085	442 016 06 21	Valve Cover Gasket (2,50mm Double Silicone)	Pcs.	
401.010	442 011 00 80	Eccentric Cover Gasket	Pcs.	
401.010.2	442 011 00 80	Eccentric Cover Gasket (Wired)	Pcs.	
401.013	407 015 03 80	Flywheel Ventilation Gasket	Pcs.	
401.112	442 015 01 80	Flywheel Rear Set Gasket	Pcs.	
401.131	442 201 10 80	Water Pump Gasket	Pcs.	
401.134	442 201 04 80	Camel Neck Gasket	Pcs.	
401.134.2	442 201 04 80	Camel Neck Gasket (Wired)	Pcs.	
402.134	442 201 03 80	Camel Neck Gasket	Pcs.	
401.150	442 141 17 80	Intake Manifold Gasket	Pcs.	
421.150	442 141 09 80	Intake Manifold Gasket (Aluminum)	Pcs.	
402.155	442 141 07 80	Suction Pipe Gasket (Klingrite)	Pcs.	
402.155.2	442 141 07 80	Suction Pipe Gasket (Wired)	Pcs.	
441.155	442 112 07 80	Suction Pipe Gasket (Wired)	Pcs.	
401.160	403 142 03 80	Exhaust Manifold Gasket	Pcs.	
352.180		AKS Front Cover Gasket	Pcs.	
401.180		AKS Back Cover Gasket	Pcs.	
401.260		Thermostat Gasket	Pcs.	
401.403	442 188 05 80	Oil Pan Gasket	Pcs.	
401.404		Gasket	Pcs.	
401.405	917003036003	Retarder Gasket	Pcs.	
401.406	917003266003	Oil Cooler Gasket	Pcs.	
401.413	355 997 01 49	Side Gasket	Pcs.	
401.414		Gasket	Pcs.	
401.418		Suction Top Gasket	Pcs.	
401.490		Intercol Gasket (2,50 mm Klingrite)	Pcs.	
401.490.2		Intercol Gasket (2,50 mm Wired)	Pcs.	
401.501	421 142 01 80	Turbo Gasket (Square)	Pcs.	
401.502	427 144 01 80	Turbo Gasket 441-442 LA 3031(Round)	Pcs.	
401.504	442 187 01 80	Turbo Gasket (Small)	Pcs.	
401.505	442 187 00 80	Turbo Gasket (Big)	Pcs.	
441.506	422 997 00 40	Turbo O-ring	Pcs.	
442.603	006 997 48 48	Turbo O-ring	Pcs.	
401.791	442 015 00 60	Rubber Gasket AcM	Pcs.	



Dortrenk Turizm Gayr. Mot.Tas.San. ve Tic. Ltd.Şti.
Tax Administration & No:
 Ikitelli / 313 058 5172
Address :
 Ikitelli O.S.B Dolapdere Sanayi Sitesi 12.Ada No:56
 Basaksehir / Istanbul / Turkiye
Tel :+90 (212) 243 02 03 Fax: +90 (212) 355 02 42
Email: bilgi@otobusyedekparca.com

01-2017

For Mercedes Benz			OM-345 / 407 / 409 / 447			
280.050	280.050.1	281.050	281.050.1	280.060		
280.070	401.070		401.010	401.131	280.112	
401.081	280.012	280.180	280.069	280.065	240.490	
421.150	401.160	302.170	401.501	401.502	401.504	401.505
401.260	401.134	240.303	401.013	401.413	401.454	
401.403	401.408	401.409	401.404	401.405	401.406	401.407



Dortrenk Turizm Gayr. Mot.Tas.San. ve Tic. Ltd.Şti.
Tax Administration & No:
 Ikitelli / 313 058 5172
Address :
 Ikitelli O.S.B Dolapdere Sanayi Sitesi 12.Ada No:56
 Basaksehir / Istanbul / Turkiye
Tel :+90 (212) 243 02 03 Fax: +90 (212) 355 02 42
Email: bilgi@otobusyedekparca.com

01-2017

For Mercedes Benz		OM-345 / 407 / 409 / 447		
Imsp Ref.	Orj. Ref.	DESCRIPTION	Unit	
345.100		Full Set (345 Otobüs / 447 Engine)	Set.	
441.101	444 010 01 20	Cylinder Head Gasket (125Ø Rubber)	Set.	
442.101	444 010 01 20	Cylinder Head Gasket (128Ø Rubber)	Set.	
345.102		Half Set Gasket-(19.422-)	Set.	
345.104		Half Set Conta (Rubber Stamp) (19.422 Attractive)	Set.	
441.050	442 016 04 20	Cylinder Gasket (125Ø Rubber) elring no:412.180	Pcs.	
442.050	442 016 06 20	Cylinder Gasket (128Ø Rubber) elring no:896.510	Pcs.	
280.060	51 0590 40132	Oil Pan Gasket	Pcs.	
280.061		Oil Pan Gasket (4 Pcs)	Pcs.	
280.065		Suction Gasket	Pcs.	
280.069	51 96601 0168	Side Block Gasket	Pcs.	
280.070	51 05901 0119	Oil Radiator Gasket	Pcs.	
280.081	51 03905 0134	Valve Cover Gasket (Silicone)	Pcs.	
280.012		Front Klingrite Gasket	Pcs.	
280.112	51 01903 0252	Flywheel Rear Gasket	Pcs.	
280.131	51 06901 0147	Water Pump Gasket (New Model)	Pcs.	
280.180	650 336 0180	AKS Gasket	Pcs.	
240.490		Intercol Gasket	Pcs.	
240.490.1		Intercol Gasket (Wired Klingrite)	Pcs.	
280.490		Intercol Gasket	Pcs.	
280.603		Steering Pump Gasket	Pcs.	
401.068		Oil Rod Gasket	Pcs.	
421.070	442 188 05 80	Oil Radiator Gasket (Silicone)	Pcs.	
401.010	442 011 00 80	Eccentric Cover Gasket	Pcs.	
401.010.2	442 011 00 80	Eccentric Cover Gasket (Wired)	Pcs.	
401.013	407 015 03 80	Flywheel Ventilation Gasket	Pcs.	
401.131	442 201 10 80	Water Pump Gasket	Pcs.	
401.134	442 201 04 80	Camel Neck Gasket	Pcs.	
401.134.2	442 201 04 80	Camel Neck Gasket (Wired)	Pcs.	
402.134	442 201 03 80	Camel Neck Gasket	Pcs.	
421.150	442 141 09 80	Intake Manifold Gasket (Aluminum)	Pcs.	
401.160	403 142 03 80	Exhaust Manifold Gasket	Pcs.	
302.170	355 141 03 80	Exhaust Throat Gasket (78Ø)	Pcs.	
401.170	442 492 00 80	Exhaust Throat Gasket (88Ø)	Pcs.	
401.260		Thermostat Gasket	Pcs.	
441.501	421 142 01 80	Turbo Gasket	Pcs.	
441.502	427 144 01 80	Turbo Gasket 441-442 LA 3031	Pcs.	
401.504	442 187 01 80	Turbo Gasket	Pcs.	
401.505	442 187 00 80	Turbo Gasket	Pcs.	
441.506	422 997 00 40	Turbo O-ring	Pcs.	



Dortrenk Turizm Gayr. Mot.Tas.San. ve Tic. Ltd.Şti.
Tax Administration & No:
 Ikitelli / 313 058 5172
Address :
 Ikitelli O.S.B Dolapdere Sanayi Sitesi 12.Ada No:56
 Basaksehir / Istanbul / Turkiye
Tel :+90 (212) 243 02 03 Fax: +90 (212) 355 02 42
Email: bilgi@otobusyedekparca.com

01-2017

For Mercedes Benz		OM.403 TRAVEGO EURO 3 TYPE			
457.050	457.101	457.106	457.060	457.112	
457.070	457.010	458.060		501.010	
457.080	457.081	457.131	457.130	457.134	402.134
457.201	457.203	457.155	457.0462	457.183	457.182
457.113	457.115	457.047	457.048	457.049	421.079
401.406	501.0745	457.151	501.160	457.501	460.501
457.301	501.604	457.603	457.604	457.605	402.260



Dortrenk Turizm Gayr. Mot.Tas.San. ve Tic. Ltd.Şti.
Tax Administration & No:
 Ikitelli / 313 058 5172
Address :
 Ikitelli O.S.B Dolapdere Sanayi Sitesi 12.Ada No:56
 Basaksehir / Istanbul / Turkiye
Tel :+90 (212) 243 02 03 Fax: +90 (212) 355 02 42
Email:bilgi@otobusyedekparca.com

01-2017

For Mercedes Benz		OM-403 TRAVEGO EURO 3 TYPE		
Imsp Ref	Orj. Ref.	DESCRIPTION	Unit	
457.100	SKC.462.451	Full Set Gasket (403 Bus Euro 3)	Set.	
457.100-1	SKC.462.451	Full Set Gasket (1840 AXOR Euro 3) 457.060 Oil Pan	Set.	
457.101	SKC.462.451	Cylinder Head Gasket (Euro 3)	Set.	
457.106		Cylinder Head Gasket Set (Euro 3)	Set.	
457.102	457 010 16 05	Half Set Gasket	Set.	
457.104		Half Set Gasket (Rubber Stamp)	Set.	
457.105		Full Set Gasket (Cylinder Cover Excluded)	Set.	
457.050	457 016 11 20	Cylinder Gasket (Elring No: 462.451)	Pcs.	
460.050		Cylinder Gasket (1,20 mm)	Pcs.	
457.060	457 014 022 2	Oil Pan Gasket (Euro 3 / Bus)	Pcs.	
457.070	457 188 02 80	Oil Radiator Gasket	Pcs.	
457.070.1	457 188 02 80	Oil Radiator Gasket (Nbr-Metal)	Pcs.	
457.070.2	457 188 02 80	Oil Radiator Gasket (Wired-Klingrite)	Pcs.	
457.071		Oil Radiator Gasket (Klingrite-Hole-Water Channel)	Pcs.	
457.071.1		Oil Radiator Gasket (Metal-Hole-Water Channel)	Pcs.	
457.071.2		Oil Radiator Gasket (Wired-Hole-Water Channel)	Pcs.	
457.080	457 016 01 21	Valve Cover Gasket	Pcs.	
457.081	457 016 00 21	Valve Cover Gasket (Aluminum)	Pcs.	
457.010	457 011 08 80	Eccentric Front Cover Gasket (Klingrite)	Pcs.	
457.010-1	457 011 08 80	Eccentric Front Cover Gasket (Nbr-Metal)	Pcs.	
457.010-2	457 011 08 80	Eccentric Front Cover Gasket (Wired Klingrite)	Pcs.	
501.010	541 011 01 80	Eccentric Cover Gasket	Pcs.	
501.010-1	541 011 01 80	Eccentric Cover Gasket (Nbr Klingrite)	Pcs.	
501.010-2	541 011 01 80	Eccentric Cover Gasket (Wired)	Pcs.	
457.047	457 201 01 80	Gasket	Pcs.	
457.048	457 201 01 80	Gasket	Pcs.	
457.049	457 201 01 80	Gasket	Pcs.	
457.112	457 015 01 80	Flywheel Rear Gasket	Pcs.	
457.113	000 018 07 80	Gasket (Acm)	Pcs.	
457.115	000 018 10 80	Gasket (Acm)	Pcs.	
457.131	457 201 10 01	Water Pump Gasket	Pcs.	
457.134	457 201 00 80	Water Pump Gasket (Aluminum)	Pcs.	
457.151	442 201 04 80	Intake Manifold Gasket-(Euro 3 / Acm)	Pcs.	
457.155	457 112 01 80	Gasket	Pcs.	
501.160	457 098 00 80	Exhaust manifold Gasket	Pcs.	
457.182	541 142 01 80	Poria Stamp	Pcs.	
457.183		Hive Stamp	Pcs.	
457.0462		AXOR 1840 Hive Nut Stamp	Pcs.	
402.260	943 332 04 62	Thermostat O-ring	Pcs.	
457.501	024 997 28 48	Turbo Gasket	Pcs.	
460.501	457 142 00 80	Turbo Gasket	Pcs.	
457.500		Turbo Set Gasket	Pcs.	
457.603		Turbo O-ring (Viton / 1840)	Pcs.	
457.604	026 997 38 48	Pompa O-ring (Viton 47x52x2.5 mm)	Pcs.	
457.605	023 997 64 48	Pompa O-ring (Viton 45x50x2.5 mm)	Pcs.	
501.0745		Holder O-ring (25 x 3,70 / Atego-Axor-Actros)	Pcs.	
421.079	541 997 07 45	Oil Cooler Gasket (Aluminum)	Pcs.	
457.201		Gasket	Pcs.	
457.203		Gasket	Pcs.	
457.301		Gasket	Pcs.	
457.406	457 015 00 80	Gasket	Pcs.	
501.604		Injektör O-ring (11x 3)	Pcs.	



Dortrenk Turizm Gayr. Mot.Tas.San. ve Tic. Ltd.Şti.

Tax Administration & No:

Ikitelli / 313 058 5172

Adress :

Ikitelli O.S.B Dolapdere Sanayi Sitesi 12.Ada No:56
Basaksehir / Istanbul / Turkiye

Tel :+90 (212) 243 02 03 Fax: +90 (212) 355 02 42

Email: bilgi@otobusyedekparca.com

01-2017



Dortrenk Turizm Gayr. Mot.Tas.San. ve Tic. Ltd.Şti.
Tax Administration & No:
 Ikitelli / 313 058 5172
Adress :
 Ikitelli O.S.B Dolapdere Sanayi Sitesi 12.Ada No:56
 Basaksehir / Istanbul / Turkiye
Tel :+90 (212) 243 02 03 Fax: +90 (212) 355 02 42
Email: bilgi@otobusyedekparca.com

01-2017

For Mercedes.Benz		AXOR 1840 / TRAVEGO EURO 4 NEW MODEL			
460.050	460.101	460.106	457.101	458.060	
457.070	457.080	457.081	457.010	501.010	
457.131	457.155	457.134	457.201	421.079	
457.0462	457.183	457.182	457.047	457.048	457.049
457.113	457.115	457.203	457.301	401.406	402.260
457.150	457.151	457.160	457.501	460.501	457.112
457.603	457.604	457.605	501.0745	501.604	457.079



Dortrenk Turizm Gayr. Mot.Tas.San. ve Tic. Ltd.Şti.
Tax Administration & No:
 Ikitelli / 313 058 5172
Address :
 Ikitelli O.S.B Dolapdere Sanayi Sitesi 12.Ada No:56
 Basaksehir / Istanbul / Turkiye
Tel :+90 (212) 243 02 03 Fax: +90 (212) 355 02 42
Email: bilgi@otobusyedekparca.com

01-2017

For Mercedes Benz		AXOR 1840- TRAVEGO / EURO 4 NEW MODEL		
Imsp Ref	Orj. Ref.	DESCRIPTION	Unit	
458.100	SKC.462.202	Full Set Gasket (1840-Travego)	Set.	
458.100-1	SKC.462.202	Full Set Gasket (1840-Travego)	Set.	
457.101	SKC.462.451	Cylinder Head Gasket (Euro 3) E/M	Set.	
460.101	SKC.462.202	Cylinder Head Gasket (Euro 4-5)	Set.	
460.106	SKC.462.202	Cylinder Head Gasket (Euro 4-5)	Set.	
458-102		Half Set Gasket (Euro 3-4)	Set.	
457.104		Half Set Gasket (Rubber Stamp)	Set.	
457.105		Full Set Gasket (Cylinder Cover Excluded)	Set.	
457.050	460 016 12 20	Cylinder Gasket	Pcs.	
460.050		Cylinder Gasket (Elring No: 462 202 Euro 4-5)	Pcs.	
458.060	457 014 01 22	Oil Pan Gasket (Euro 3 / 1840 Axor)	Pcs.	
457.070	457 188 02 80	Oil Radiator Gasket	Pcs.	
457.070-1	457 188 02 80	Oil Radiator Gasket (Nbr-Metal)	Pcs.	
457.070.2	457 188 02 80	Oil Radiator Gasket (Wired-Klingrite)	Pcs.	
457.071		Oil Radiator Gasket (Klingrite-Hole-Water Channel)	Pcs.	
457.071-1		Oil Radiator Gasket (Metal-Hole-Water Channel)	Pcs.	
457.071-2		Oil Radiator Gasket (Wired-Hole-Water Channel)	Pcs.	
457.079		Gasket	Pcs.	
457.080	457 016 01 21	Valve Cover Gasket	Pcs.	
457.081	457 016 00 21	Valve Cover Gasket (Aluminum)	Pcs.	
457.010	457 011 08 80	Eccentric Front Cover Gasket (Klingrite)	Pcs.	
457.010-1	457 011 08 80	Eccentric Front Cover Gasket (Nbr-Metal)	Pcs.	
457.010-2	457 011 08 80	Eccentric Front Cover Gasket (Wired Klingrite)	Pcs.	
501.010	541 011 01 80	Eccentric Cover Gasket	Pcs.	
501.010-1	541 011 01 80	Eccentric Cover Gasket (Nbr Klingrite)	Pcs.	
501.010-2	541 011 01 80	Eccentric Cover Gasket (Wired)	Pcs.	
457.047	457 201 01 80	Gasket	Pcs.	
457.048	457 201 01 80	Gasket	Pcs.	
457.049	457 201 01 80	Gasket	Pcs.	
457.112	457 015 01 80	Flywheel Rear Gasket	Pcs.	
457.113		Gasket (Acm)	Pcs.	
457.115		Gasket (Acm)	Pcs.	
457.131	457 201 00 80	Water Pump Gasket	Pcs.	
457.134	442 201 04 80	Water Pump Gasket (Aluminum)	Pcs.	
457.150	457 141 00 80	Intake Manifold Gasket (Aluminum)	Pcs.	
457.151	457 112 01 80	Intake Manifold Gasket (Euro 3 / Acm)	Pcs.	
457.155	457 098 00 80	Gasket	Pcs.	
457.160	541 142 01 80	Exhaust Manifold Gasket	Pcs.	
457.182		AKS Poria Stamp	Pcs.	
457.183		Hive Gasket	Pcs.	
457.0462	943 332 04 62	AXOR 1840 Hive Nut Stamp	Pcs.	
402.260	024 997 28 48	Thermostat O-ring	Pcs.	
457.501	457 142 00 80	Turbo Gasket	Pcs.	
460.501		Turbo Gasket	Pcs.	
457.500		Turbo Set Gasket	Pcs.	
457.603	026 997 38 48	Turbo O-ring (Viton / 1840)	Pcs.	
457.604	023 997 64 48	Pompa O-ring (Viton 47x52x2.5 mm)	Pcs.	
457.605		Pompa O-ring (Viton 45x50x2.5 mm)	Pcs.	
501.0745	541 997 07 45	Holder O-ring (25 x 3,70 / Atego-Axor-Actros)	Pcs.	
421.079		Oil Cooler Gasket (Aluminum)	Pcs.	
457.201		Gasket	Pcs.	
457.203		Gasket	Pcs.	
457.301	457 015 00 80	Gasket	Pcs.	
401.406		Gasket	Pcs.	
501.604		Injektör O-ring (11x 3)	Pcs.	



Dortrenk Turizm Gayr. Mot.Tas.San. ve Tic. Ltd.Şti.

Tax Administration & No:

Ikitelli / 313 058 5172

Adress :

Ikitelli O.S.B Dolapdere Sanayi Sitesi 12.Ada No:56

Basaksehir / Istanbul / Turkiye

Tel :+90 (212) 243 02 03 Fax: +90 (212) 355 02 42

























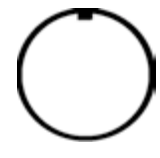











Email: bilgi@otobusyedekparca.com

01-2017



Dortrenk Turizm Gayr. Mot.Tas.San. ve Tic. Ltd.Şti.
Tax Administration & No:
Ikitelli / 313 058 5172
Adress :
Ikitelli O.S.B Dolapdere Sanayi Sitesi 12.Ada No:56
Basaksehir / Istanbul / Turkiye
Tel :+90 (212) 243 02 03 Fax: +90 (212) 355 02 42
Email: bilgi@otobusyedeckparca.com

01-2017

For Mercedes.Benz		TRAVEGO 457 – AXOR 1840 . 3240 . 4140 / EURO 5					
			 1840 AXOR / ACTROS ÇEKİCİ - TRAVEGO				
460.050	460.101	460.106	460.060				
	 KLINGRIT						
457.080	457.081	457.010	457.070	457.131	501.010		
							
029.021	457.155	457.0462	457.183	457.182	457.112		
							
457.134	457.047	457.048	457.049	421.079	457.113	457.115	
							
457.150	457.160	457.501		460.501	401.406	402.260	
							
457.201	457.203	457.301	457.603	501.604	457.604	457.605	501.0745



Dortrenk Turizm Gayr. Mot.Tas.San. ve Tic. Ltd.Şti.
Tax Administration & No:
 Ikitelli / 313 058 5172
Address :
 Ikitelli O.S.B Dolapdere Sanayi Sitesi 12.Ada No:56
 Basaksehir / Istanbul / Turkiye
Tel :+90 (212) 243 02 03 Fax: +90 (212) 355 02 42
Email:bilgi@otobusyedekparca.com

01-2017

For Mercedes		TRAVEGO 457 – AXOR 1840 - 3240 - 4140 / EURO 5		
Imsp Ref	Orj. Ref.	DESCRIPTION		
460.100		Full Set Gasket (1840-3240-4140 Travego Axor Euro 4-5)	Set.	
460.101	SKC.462.202	Cylinder Head Gasket (Euro 4-5)	Set.	
460.106	SKC.462.202	Cylinder Head Gasket Seti (Euro 4-5)	Set.	
460.102		Half Set Gasket	Set.	
460.104		Half Set Gasket (Rubber-Stamp)	Set.	
460.105		Full Set Gasket (Cylinder Cover Excluded)	Set.	
460.050	460 016 12 20	Cylinder Gasket (Elring No: 462 202 Euro 4)	Pcs.	
460.060	457 014 01 22	Oil Pan Gasket (Euro 3 / 1840 Axor)	Pcs.	
457.061	457 014 02 22	Oil Pan Gasket (Euro 3 / Travego)	Pcs.	
457.070	457 188 02 80	Oil Radiator Gasket	Pcs.	
457.070-1	457 188 02 80	Oil Radiator Gasket (Nbr-Metal)	Pcs.	
457.070-2	457 188 02 80	Oil Radiator Gasket (Wired-Klingrite)	Pcs.	
457.071		Oil Radiator Gasket (Klingrite-Hole-Water Channel)	Pcs.	
457.071-1		Oil Radiator Gasket (Metal-Hole-Water Channel)	Pcs.	
457.071-2		Oil Radiator Gasket (Wired-Hole-Water Channel)	Pcs.	
457.080	457 016 01 21	Valve Cover Gasket	Pcs.	
457.081	457 016 00 21	Valve Cover Gasket (Aluminum)	Pcs.	
457.010	457 011 08 80	Eccentric Front Cover Gasket (Klingrite)	Pcs.	
457.010-1	457 011 08 80	Eccentric Front Cover Gasket (Nbr-Metal)	Pcs.	
457.010-2	457 011 08 80	Eccentric Front Cover Gasket (Wired Klingrite)	Pcs.	
501.010	541 011 01 80	Eccentric Cover Gasket	Pcs.	
501.010-1	541 011 01 80	Eccentric Cover Gasket (Nbr Klingrite)	Pcs.	
501.010-2	541 011 01 80	Eccentric Cover Gasket (Wired)	Pcs.	
457.047	457 201 01 80	Gasket	Pcs.	
457.048	457 201 01 80	Gasket	Pcs.	
457.049	457 201 01 80	Gasket	Pcs.	
457.112	457 015 01 80	Flywheel Rear Gasket	Pcs.	
457.113		Gasket (Acm)	Pcs.	
457.115		Gasket (Acm)	Pcs.	
457.131	457 201 00 80	Water Pump Gasket	Pcs.	
457.134	442 201 04 80	Water Pump Gasket (Aluminum)	Pcs.	
457.150	457 141 00 80	Intake Manifold Gasket (Aluminum)	Pcs.	
457.155	457 098 00 80	Gasket	Pcs.	
457.160	541 142 01 80	Exhaust Manifold Gasket	Pcs.	
457.182		Poria Stamp	Pcs.	
457.183		Hive Stamp	Pcs.	
457.0462	943 332 04 62	AXOR 1840 Hive Nut Stamp	Pcs.	
402.260	024 997 28 48	Thermostat O-ring	Pcs.	
457.500		Turbo Set Gasket	Pcs.	
457.501	457 142 00 80	Turbo Gasket	Pcs.	
460.501		Turbo Gasket	Pcs.	
457.603	026 997 38 48	Turbo O-ring (FKM/ 1840)	Pcs.	
457.604	023 997 64 48	O-ring (FKM 47x52x2.5 mm)	Pcs.	
457.605		O-ring (FKM 45x50x2.5 mm)	Pcs.	
501.0745	541 997 07 45	Rubber (25 x 3,70 / Atego-Axor-Actros)	Pcs.	
421.079		Oil Cooler Gasket (Aluminum)	Pcs.	
457.201		Gasket	Pcs.	
457.203		Gasket	Pcs.	
457.301	457 015 00 80	Gasket	Pcs.	
457.406		Gasket	Pcs.	
501.604		Injektör O-ring (11x 3)	Pcs.	



Dortrenk Turizm Gayr. Mot.Tas.San. ve Tic. Ltd.Şti.

Tax Administration & No:

Ikitelli / 313 058 5172

Adress :

Ikitelli O.S.B Dolapdere Sanayi Sitesi 12.Ada No:56

Basaksehir / Istanbul / Turkiye

Tel :+90 (212) 243 02 03 Fax: +90 (212) 355 02 42

Email: bilgi@otobusyedekparca.com

01-2017



Dortrenk Turizm Gayr. Mot.Tas.San. ve Tic. Ltd.Şti.
Tax Administration & No:
 Ikitelli / 313 058 5172
Address :
 Ikitelli O.S.B Dolapdere Sanayi Sitesi 12.Ada No:56
 Basaksehir / Istanbul / Turkiye
Tel :+90 (212) 243 02 03 Fax: +90 (212) 355 02 42
Email: bilgi@otobusyedekparca.com

01-2017

For Mercedes.Benz		OM.460 TOURISMO EURO 5 TYPE			
460.050	461.101		461.060		457.112
457.070	457.080	457.081	457.010	501.010	
457.131	461.160		461.170	457.501	460.501
457.134	457.203	457.155	457.0462	457.183	457.182
457.201	402.134	457.047	457.048	457.049	421.079
457.301	401.406	457.113	457.115	462-170	
501.0745	501.604	457.603	457.604	457.605	402.260



Dortrenk Turizm Gayr. Mot.Tas.San. ve Tic. Ltd.Şti.
Tax Administration & No:
 Ikitelli / 313 058 5172
Address :
 Ikitelli O.S.B Dolapdere Sanayi Sitesi 12.Ada No:56
 Basaksehir / Istanbul / Turkiye
Tel :+90 (212) 243 02 03 Fax: +90 (212) 355 02 42
Email: bilgi@otobusyedekparca.com

01-2017

For Mercedes Benz		OM-460 TOURISMO EURO 5 TYPE		
Imsp Ref	Orj. Ref.	DESCRIPTION	Unit	
461.100	SKC.462.451	Full Set Gasket	Set.	
461.101		Cylinder Head Gasket	Set.	
461.106		Cylinder Head Gasket Set	Set.	
461.102		Half Set Gasket	Set.	
461.104		Half Set Gasket (Rubber-Stamp)	Set.	
460.050	457 016 11 20	Cylinder Gasket (Elring No: 462.451)	Pcs.	
457.050		Cylinder Gasket (1,20 mm)	Pcs.	
461.060		Oil Pan Gasket (Euro 3 / Bus)	Pcs.	
457.070	457 188 02 80	Eccentric Front Cover Gasket (Klingrite)	Pcs.	
457.070-1	457 188 02 80	Eccentric Front Cover Gasket (Nbr-Metal)	Pcs.	
457.070-2	457 188 02 80	Eccentric Front Cover Gasket (Wired Klingrite)	Pcs.	
457.071		Eccentric Cover Gasket	Pcs.	
457.071-1		Eccentric Cover Gasket (Nbr Klingrite)	Pcs.	
457.071-2		Eccentric Cover Gasket (Wired)	Pcs.	
457.080	457 016 01 21	Valve Cover Gasket	Pcs.	
457.081	457 016 00 21	Valve Cover Gasket (Aluminum)	Pcs.	
457.010	457 011 08 80	Eccentric Front Cover Gasket (Klingrite)	Pcs.	
457.010-1	457 011 08 80	Eccentric Front Cover Gasket (Nbr-Metal)	Pcs.	
457.010-2	457 011 08 80	Eccentric Front Cover Gasket (Wired Klingrite)	Pcs.	
457.047	457 201 01 80	Gasket	Pcs.	
457.048	457 201 01 80	Gasket	Pcs.	
457.049	457 201 01 80	Gasket	Pcs.	
457.112	457 015 01 80	Flywheel Rear Gasket set	Pcs.	
457.113		Gasket (Acm)	Pcs.	
457.115		Gasket (Acm)	Pcs.	
457.131	457 201 00 80	Water Pump Gasket	Pcs.	
457.134	442 201 04 80	Water Pump Gasket (Aluminum)	Pcs.	
457.155	457 098 00 80	Gasket	Pcs.	
461.160		Exhaust Gasket	Pcs.	
461.170		Exhaust Throat Gasket	Pcs.	
462.170		Exhaust Throat Gasket	Pcs.	
457.182		Poria Stamp	Pcs.	
457.183		Hive Stamp	Pcs.	
457.0462	943 332 04 62	AXOR 1840 Hive Nut Stamp	Pcs.	
402.260	024 997 28 48	Thermostat O-ring	Pcs.	
441.501	421 142 01 80	Thermostat O-ring	Pcs.	
441.502	427 144 01 80	Turbo Set Gasket	Pcs.	
457.500		Turbo Set Gasket	Pcs.	
457.501	457 142 00 80	Turbo Gasket	Pcs.	
457.501.1		Turbo Gasket	Pcs.	
457.603	026 997 38 48	Turbo O-ring (FKM / 1840)	Pcs.	
457.604	023 997 64 48	O-ring (Viton 47x52x2.5 mm)	Pcs.	
457.605		O-ring (Viton 45x50x2.5 mm)	Pcs.	
501.0745	541 997 07 45	Rubber (25 x 3,70 / Atego-Axor-Actros)	Pcs.	
421.079		Oil Cooler Gasket (Aluminum)	Pcs.	
457.201		Gasket	Pcs.	
457.203		Gasket	Pcs.	
457.301	457 015 00 80	Gasket	Pcs.	
457.406		Gasket	Pcs.	
501.604		Injektör O-ring-(11x 3)	Pcs.	



Dortrenk Turizm Gayr. Mot.Tas.San. ve Tic. Ltd.Şti.
Tax Administration & No:
 Ikitelli / 313 058 5172
Adress :
 Ikitelli O.S.B Dolapdere Sanayi Sitesi 12.Ada No:56
 Basaksehir / Istanbul / Turkiye
Tel :+90 (212) 243 02 03 Fax: +90 (212) 355 02 42
Email: bilgi@otobusyedekparca.com

01-2017

For Mercedes.Benz	OM.470 LA ACTROS – ANTOS EURO 6 TURBO INTERCOOLER 326-428 HP 6CYL L- Ø125,00 MM		
470.050	470.060	470.080	470-380
470-480	470-580	470-180	470.0080

For Mercedes.Benz	OM.471 LA ACTROS – ANTOS EURO 6 TURBO INTERCOOLER 421-510 HP 6CYL L- Ø132,00 MM				
471.050	471-060	471-112	471-080		
471-160	471-161	471-010	471.780		
471-155	471-150	471-501	471-156	471-070	471-073
471.280	471.0080	471.580	471.605	472.080	



Dortrenk Turizm Gayr. Mot.Tas.San. ve Tic. Ltd.Şti.
Tax Administration & No:
 Ikitelli / 313 058 5172
Address :
 Ikitelli O.S.B Dolapdere Sanayi Sitesi 12.Ada No:56
 Basaksehir / Istanbul / Turkiye
Tel :+90 (212) 243 02 03 Fax: +90 (212) 355 02 42
Email: bilgi@otobusyedekparca.com

01-2017

For Mercedes.Benz		OM.470 LA ACTROS – ANTOS EURO 6 TURBO INTERCOOLER 326-428 HP 6CYL L- Ø125,00 MM		
Imsp Ref	Orj. Ref.	DESCRIPTION	Unit	
470.050		Cylinder Cover Gasket	Pcs	
470.060		Gasket	Pcs	
470.180		Gasket	Pcs	
470.380		Gasket	Pcs	
470.480		Gasket	Pcs	
470.580		Gasket	Pcs	
470.080		Gasket	Pcs	
470.0080		Gasket	Pcs	

For Mercedes.Benz		OM.471 LA ACTROS – ANTOS EURO 6 TURBO INTERCOOLER 421-510 HP 6CYL L- Ø132,00 MM		
Imsp Ref	Orj. Ref.	DESCRIPTION	Unit	
471.050		Cylinder Cover Gasket	Pcs.	
471.060		Oil Pan Gasket	Pcs	
471.070		Oil Radiator Gasket	Pcs	
471.073		Oil Radiator Gasket	Pcs	
471.080		Valve Cover Gasket (Rubber)	Pcs	
471.112		Flywheel Rear Gasket	Pcs	
471.150		Intake Manifold Gasket	Pcs	
471.155		Intake Manifold Gasket (Weather)	Pcs	
471.156		Intake Manifold Gasket (Exit)	Pcs	
471.160		Exhaust Manifold Gasket	Pcs	
471.161		Exhaust Manifold Gasket	Pcs	
471.0080		Gasket	Pcs	
471.280		Gasket	Pcs	
471.580		Gasket	Pcs	
471.780		Gasket	Pcs	
471.501		Turbo Gasket	Pcs	
471.605		Gasket	Pcs	
472.080		Gasket	Pcs	



Dortrenk Turizm Gayr. Mot.Tas.San. ve Tic. Ltd.Şti.
Tax Administration & No:
 Ikitelli / 313 058 5172
Adress :
 Ikitelli O.S.B Dolapdere Sanayi Sitesi 12.Ada No:56
 Basaksehir / Istanbul / Turkiye
Tel :+90 (212) 243 02 03 Fax: +90 (212) 355 02 42
Email: bilgi@otobusyedekparca.com

01-2017

For Mercedes.Benz		OM.501 / 541 ACTROS TRAVEGO MP1 / MP 2 V/6			
501.050 MPI	501.101	501.060		541.060 ACM	
541.050	541.101	501.010	501.070	501.112	
501.080	501.130	501.131	501.0362	501.180	502.180
501.150	501.160	441.603	501.401	501.134	
501.403	501.290	501.406	401.504	501.079	501.155
501.791	501.792	501.793	501.794	501.0745	
441.501	441.502	501.551	401.505	501.604	541.0080



Dortrenk Turizm Gayr. Mot.Tas.San. ve Tic. Ltd.Şti.
Tax Administration & No:
 Ikitelli / 313 058 5172
Address :
 Ikitelli O.S.B Dolapdere Sanayi Sitesi 12.Ada No:56
 Basaksehir / Istanbul / Turkiye
Tel :+90 (212) 243 02 03 Fax: +90 (212) 355 02 42
Email:bilgi@otobusyedekparca.com

01-2017

For Mercedes		OM-501 / 541 ACTROS TRAVEGO MP1 / MP 2 V/6		
Imsp Ref.	Orj. Ref.	DESCRIPTION	Unit	
501.100	052.480	Full Set Gasket (MP 1) Trevego	Set.	
501.100.1	052.480	Full Set Gasket (MP 1) Actros	Set.	
541.100	066.722	Full Set Gasket (MP 2) Trevego	Set.	
541.100.1	066.722	Full Set Gasket (MP2) Actros	Set.	
501.101	052.480	Cylinder Head Gasket (MP1)	Set.	
541.101	066.722	Cylinder Head Gasket (MP2)	Set.	
501.106	052.480	Cylinder Head Gasket Set (MP 1)	Set.	
541.106	066.722	Cylinder Head Gasket Set (MP 2)	Set.	
501.102		Half Set Gasket	Set.	
541.102		Half Set Gasket	Set.	
501.104		Half Set Gasket (Rubber/Stamp) Travego (Klingrite-Oil Pan)	Set.	
541.104		Half Set Gasket (Rubber/Stamp) Actros (Oil Pan Rubber)	Set.	
501.105		Full Set Gasket (Cylinder Cover Excluded) Travego (Oil Pan Klingrite)	Set.	
541.105		Full Set Gasket (Cylinder Cover Excluded)) Actros (Oil Pan Rubber)	Set.	
501.050	541 016 11 20	Cylinder Gasket (MP1 / Elring No:052.480)	Pcs.	
541.050	541 016 13 20	Cylinder Gasket (MP 2 /Elring No:066.720)	Pcs.	
501.060	541 014 03 22	Oil Pan Gasket	Pcs.	
541.060	541 014 07 22	Oil Pan Gasket(Acm / Rubber)	Pcs.	
501.070	541 184 07 80	Gasket (Klingrite)	Pcs.	
501.070-1	541 184 07 80	Gasket (Nbr Metal)	Pcs.	
501.079		Gasket	Pcs.	
501.080	541 016 04 21	Valve Cover Gasket	Pcs.	
501.010	541 011 01 80	Eccentric Front Cover Gasket	Pcs.	
501.010-1	541 011 01 80	Eccentric Front Cover Gasket (Nbr-Metal)	Pcs.	
501.010-2	541 011 01 80	Eccentric Front Cover Gasket (Wired)	Pcs.	
501.112	541 015 11 80	Flywheel Rear Gasket Set	Pcs.	
501.130		Water Pump Gasket Set	Set.	
501.131	542 201 01 80	Water Pump Gasket	Pcs.	
501.134	942 501 00 80	Water Pump Gasket	Pcs.	
501.134-1	942 501 00 80	Water Pump Gasket (Wired Klingrite)	Pcs.	
501.150	541 098 04 80	Intake Manifold Gasket	Pcs.	
501.160	541 142 01 80	Exhaust Manifold Gasket	Pcs.	
501.155		Travego Gasket	Pcs.	
501.155.1		Travego Gasket NBR Metal	Pcs.	
501.161	541 142 01 80	Exhaust Manifold Gasket	Pcs.	
501.180	38 9334 00 80	Gasket (Setra)	Pcs.	
502.180	94 3334 00 80	Gasket	Pcs.	
501.0362	943 332 04 62	Stamp	Pcs.	
501.290		Gasket	Pcs.	
501.291		Oring Fkm	Pcs.	
501.401		Gasket	Pcs.	
501.401-1		Gasket (Nbr Metal)	Pcs.	
501.403		Gasket	Pcs.	
501.406	541 201 01 80	Gasket	Pcs.	
401.504	442 187 01 80	Turbo Gasket	Pcs.	
401.505	442 187 00 80	Turbo Gasket	Pcs.	
441.603	021 997 52 48	Turbo O-ring (58 x 68 x 8)	Pcs.	
441.501	421 142 01 80	Turbine Square Gasket	Pcs.	
441.502	427 144 01 80	Turbine Roaun Gasket (441.442 LA 3031)	Pcs.	
501.604	541 997 06 45	Injektör O-ring (11x 3)	Pcs.	
501.791	541 015 13 80	Gaket (Acm)	Pcs.	
501.792		Vacuum Gasket	Pcs.	
501.793		Rubber	Pcs.	
501.794		Rubber	Pcs.	



Dortrenk Turizm Gayr. Mot.Tas.San. ve Tic. Ltd.Şti.

Tax Administration & No:

Ikitelli / 313 058 5172

Adress :

Ikitelli O.S.B Dolapdere Sanayi Sitesi 12.Ada No:56

Basaksehir / Istanbul / Turkiye

Tel :+90 (212) 243 02 03 Fax: +90 (212) 355 02 42

Email: bilgi@otobusyedekparca.com

01-2017

501.0745	541 997 07 45	Oring (25 x 3,70 / Atego-Axor-Actros)	Pcs.	
541.0080	541 188 00 80	Oil Filter Gasket	Pcs.	



Dortrenk Turizm Gayr. Mot.Tas.San. ve Tic. Ltd.Şti.
Tax Administration & No:
 Ikitelli / 313 058 5172
Adress :
 Ikitelli O.S.B Dolapdere Sanayi Sitesi 12.Ada No:56
 Basaksehir / Istanbul / Turkiye
Tel :+90 (212) 243 02 03 Fax: +90 (212) 355 02 42
Email: bilgi@otobusyedekparca.com

01-2017

For Mercedes.Benz		ACTROS.SETRA OM.502. V/8 TRAVEGO DOUBLE AXLE			
501.050 MPI	501.101	502.060 V/8	542.060 ACM V/8	501.070	
541.050	541.101	501.131	501.130	502.112	501.010
501.791	501.792	501.793	501.794	501.0745	
501.080	502.180	541.0080	501.155	441.502	
501.0362	501.403	501.401	501.150	501.160	441.501
501.180	501.290	501.134	401.504	401.505	
501.406	501.604	441.603	501-551		



Dortrenk Turizm Gayr. Mot.Tas.San. ve Tic. Ltd.Şti.
Tax Administration & No:
 Ikitelli / 313 058 5172
Address :
 Ikitelli O.S.B Dolapdere Sanayi Sitesi 12.Ada No:56
 Basaksehir / Istanbul / Turkiye
Tel :+90 (212) 243 02 03 Fax: +90 (212) 355 02 42
Email:bilgi@otobusyedekparca.com

01-2017

For Mercedes Benz		ACTROS-SETRA OM-502- V/8 TRAVEGO DOUBLE AXLE		
Imsp Ref.	Orj. Ref.	DESCRIPTION	Unit	
502.100	052.480	Full Set Gasket (MP 1) Trevego	Set.	
502.100.1	052.480	Full Set Gasket (MP 1) Actros	Set.	
542.100	066.722	Full Set Gasket (MP 2) Trevego	Set.	
542.100.1	066.722	Full Set Gasket (MP2) Actros	Set.	
501.101	052.480	Cylinder Head Gasket (MP1)	Set.	
541.101	066.722	Cylinder Head Gasket (MP2)	Set.	
501.106	052.480	Cylinder Head Gasket Set (MP 1)	Set.	
541.106	066.722	Cylinder Head Gasket Set (MP 2)	Set.	
502.102		Half Set Gasket	Set.	
542.102		Half Set Gasket	Set.	
502.104		Half Set Gasket (Rubber/Stamp) Travego (Oil Pan-Klingrite)	Set.	
542.104		Half Set Gasket (Rubber/Stamp) Actros (Oil Pan-Rubber)	Set.	
502.105		Full Set Gasket (Cylinder Cover Excluded) Travego (Oil Pan-Klingrite)	Set.	
542.105		Full Set Gasket (Cylinder Cover Excluded) Actros (Oil Pan-Rubber)	Set.	
501.050	541 016 11 20	Cylinder Gasket-(MP1 / Elring No:052.480)	Pcs.	
541.050	541 016 13 20	Cylinder Gasket-(MP 2 / Elring No:066.720)	Pcs.	
502.060	542 014 03 22	Oil Pan Gasket	Pcs.	
542.060	542 014 04 22	Oil Pan Gasket (Acm Rubber)	Pcs.	
501.070	541 184 07 80	Gasket	Pcs.	
501.070-1	541 184 07 80	Gasket (Nbr Met.)	Pcs.	
501.080	541 016 04 21	Valve Cover Gasket	Pcs.	
501.010	541 011 01 80	Eccentric Cover Gasket	Pcs.	
501.010-1	541 011 01 80	Eccentric Cover Gasket (Nbr-Metal)	Pcs.	
501.010-2	541 011 01 80	Eccentric Cover Gasket (Wired)	Pcs.	
502.112	541 015 12 80	Flywheel Rear Gasket Set	Pcs.	
501.130	542 201 01 80	Water Pump Gasket Set	Pcs.	
501.131	542 201 01 80	Water Pump Gasket	Pcs.	
501.134	942 501 00 80	Water Pump Gasket	Pcs.	
501.134.1	942 501 00 80	Water Pump Gasket	Pcs.	
501.150	541 098 04 80	Intake Manifold Gasket	Pcs.	
501.155		Travego Gasket	Pcs.	
501.155.1		Travego Gasket NBR Metal	Pcs.	
501.160	541 142 01 80	Exhaust Manifold Gasket	Pcs.	
501.161	541 142 01 80	Exhaust Manifold Gasket	Pcs.	
501.180	38 9334 00 80	Gasket (Setra)	Pcs.	
502.180	94 3334 00 80	Gasket	Pcs.	
501.0362		Hive Nut Stamp	Pcs.	
501.290		Gasket	Pcs.	
501.291		Oring Fkm	Pcs.	
501.401	541 201 01 80	Gasket	Pcs.	
501.401-1	541 201 01 80	Gasket (Nbr Met.)	Pcs.	
541.0080	541 188 00 80	Gasket	Pcs.	
501.403		Gasket	Pcs.	
401.406	541 201 01 80	Gasket	Pcs.	
401.504	442 187 01 80	Turbo Gasket	Pcs.	
401.505	442 187 00 80	Turbo Gasket	Pcs.	
441.501	421 142 01 80	Turbine Square Gasket	Pcs.	
441.502	427 144 01 80	Turbine Round Gasket (441.442 LA 3031)	Pcs.	
441.603	021 997 52 48	Turbo O-ring (58 x 68 x 8-3031)	Pcs.	
501.604	541 997 06 45	O-ring (11x 3)	Pcs.	
502.791	541 015 01 60	Gasket Rubber (Acm)	Pcs.	
501.792	541 015 13 80	Rubber Gasket	Pcs.	



Dortrenk Turizm Gayr. Mot.Tas.San. ve Tic. Ltd.Şti.

Tax Administration & No:

Ikitelli / 313 058 5172

Adress :

Ikitelli O.S.B Dolapdere Sanayi Sitesi 12.Ada No:56

Basaksehir / Istanbul / Turkiye

Tel :+90 (212) 243 02 03 Fax: +90 (212) 355 02 42

Email: bilgi@otobusyedekparca.com

01-2017

501.0745	541 997 07 45	Rubber (25 x 3,70 / Atego-Axor-Actros)	Pcs.	
----------	---------------	--	------	--



Dortrenk Turizm Gayr. Mot.Tas.San. ve Tic. Ltd.Şti.
Tax Administration & No:
 Ikitelli / 313 058 5172
Address :
 Ikitelli O.S.B Dolapdere Sanayi Sitesi 12.Ada No:56
 Basaksehir / Istanbul / Turkiye
Tel :+90 (212) 243 02 03 Fax: +90 (212) 355 02 42
Email: bilgi@otobusyedekparca.com

01-2017

For Mercedes.Benz		OM.904.ATEGO (1517.1518)			
904.050		904.060	924.060	924.080	
904.070	904.071	904.072	906.086	904.080	
904.085	924.085	906.190	906.210	906.087	
906.112	904.010	906.180	906.182	904.131	
906.150	904.150	906.160	926.160	904.501	
904.260	906.260	904.261	906.261	904.605	906.211
906.0660	401.504	401.505	906.403	904.404	906.0480
904.011	906.603	501.604	906.604	501.0745	



Dortrenk Turizm Gayr. Mot.Tas.San. ve Tic. Ltd.Şti.
Tax Administration & No:
 Ikitelli / 313 058 5172
Address :
 Ikitelli O.S.B Dolapdere Sanayi Sitesi 12.Ada No:56
 Basaksehir / Istanbul / Turkiye
Tel :+90 (212) 243 02 03 Fax: +90 (212) 355 02 42
Email:bilgi@otobusyedekparca.com

01-2017

For Mercedes Benz		OM-904-ATECO 1517-1518		
Imsp Ref.	Orj. Ref.	DESCRIPTION	Unit	
904.100	904 010 45 05	Full Set Gasket	Set.	
924.100	906 010 14 05	Full Set Gasket	Set.	
904.101	904 010 18 21	Cylinder Head Gasket	Set.	
924.104		Half Set Gasket	Set.	
904.104		Half Set Gasket (Rubber-Stamp)	Set.	
904.105		Full Set Gasket (Cylinder Cover Excluded)	Set.	
904.060	904 014 07 22	Oil Pan Gasket	Pcs.	
924.060	904 014 08 22	Oil Pan Gasket	Pcs.	
904.070	904 188 02 80	Gasket	Pcs.	
904.071	000 188 32 80	Gasket	Pcs.	
904.072		Gasket (Set)	Pcs.	
904.080	000 016 04 21	Valve Cover Gasket	Pcs.	
924.080	904 016 06 21	Valve Cover Gasket	Pcs.	
904.085	904 016 07 21	Valve Cover Gasket	Pcs.	
924.085	904 016 04 21	Valve Cover Gasket	Pcs.	
906.086	000 018 01 33	Valve Cover Diaphragm Gasket	Pcs.	
906.087	000 016 00 40	Valve Cover Gasket	Pcs.	
904.010	904 016 14 23	Gasket	Pcs.	
904.011		O-ring (Viton)	Pcs.	
906.112	906 015 01 80	Flywheel Rear Gasket	Pcs.	
904.131	906 201 00 80	Water Pump Gasket	Pcs.	
904.150	906 141 01 80	Intake Manifold Gasket	Pcs.	
904.150-1	906 141 01 80	Intake Manifold Gasket (Nbr Met.)	Pcs.	
906.150	904 141 02 80	Intake Manifold Gasket	Pcs.	
906.160	906 142 02 80	Exhaust Manifold Gasket	Pcs.	
906.161	906 142 02 80	Exhaust Manifold Gasket (Nbr Met.)	Pcs.	
926.160	906 142 02 80	Exhaust Manifold Gasket (Nbr Met.)	Pcs.	
906.180		Gasket	Pcs.	
906.182		Poria Stamp	Pcs.	
906.190	906 191 03 80	Gasket	Pcs.	
906.210	906 184 02 80	Oil Filter Gasket	Pcs.	
906.211	002 094 15 80	Filter Rubber	Pcs.	
904.260	906 203 01 76	Thermostat Gasket	Pcs.	
904.261		Thermostat O-ring	Pcs.	
906.260	906 203 01 80	Gasket (Aluminum)	Pcs.	
906.261		Thermostat Gasket	Pcs.	
904.404		Gasket (Nbr Metal)	Pcs.	
904.501		Turbo Gasket	Pcs.	
906.603	021 997 84 48	Turbo O-ring Fkm	Pcs.	
906.604		O-ring Fkm	Pcs.	
906.605	027 997 83 48	O-ring Fkm	Pcs.	
501.604	541 997 06 45	O-ring (11x 3)	Pcs.	
906-403		Gasket	Pcs.	
906.0660	906 017 0660	Injektör Stamp	Pcs.	
906.0480	906 203 04 80	Gasket	Pcs.	
501.0745	541 997 07 45	Rubber (25 x 3,70 / Atego-Axor-Actros)	Pcs.	



Dortrenk Turizm Gayr. Mot.Tas.San. ve Tic. Ltd.Şti.
Tax Administration & No:
 Ikitelli / 313 058 5172
Adress :
 Ikitelli O.S.B Dolapdere Sanayi Sitesi 12.Ada No:56
 Basaksehir / Istanbul / Turkiye
Tel :+90 (212) 243 02 03 Fax: +90 (212) 355 02 42
Email: bilgi@otobusyedekparca.com

01-2017

For Mercedes.Benz		OM 906.AXOR (3028.3228.3240) ATEGO (2124)			
906.050		906.060		926.060	
906.070	906.071	906.072	906.080		
926.080		906.085		926.085	
906.112	904.010	904.131	906.086	906.087	906.210
906.150	904.150	906.160	926.160	906.501	
904.260	906.260	906.261	904.261	904.404	906.211
906.180	906.182	906.190	906.403	401.504	401.505
906-0660	906.603	501.604	906.604	904.605	906.0480



Dortrenk Turizm Gayr. Mot.Tas.San. ve Tic. Ltd.Şti.
Tax Administration & No:
 Ikitelli / 313 058 5172
Address :
 Ikitelli O.S.B Dolapdere Sanayi Sitesi 12.Ada No:56
 Basaksehir / Istanbul / Turkiye
Tel :+90 (212) 243 02 03 Fax: +90 (212) 355 02 42
Email: bilgi@otobusyedekparca.com







01-2017



















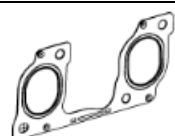





For Mercedes Benz		OM 906- AXOR (3028-3228-3240) ATEGO (2124)		
ImspRef.	Orj. Ref.	DESCRIPTION	Unit	
906.100	906 010 45 05	Full Set Gasket	Set.	
926.100		Full Set Gasket	Set.	
906.101	906 010 54 21	Cylinder Head Gasket	Set.	
926.104		Half Set Gasket	Set.	
906.104		Half Set Gasket (Rubber/Stamp)	Set.	
906.105		Full Set Gasket (Cylinder Cover Excluded)	Set.	
906.060	906 014 05 22	Oil Pan Gasket	Pcs.	
926.060	906 014 04 22	Oil Pan Gasket	Pcs.	
906.070	906 188 02 80	Gasket	Pcs.	
906.071	000 188 33 80	Gasket	Pcs.	
906.072		Gasket	Set.	
906.080	000 016 05 21	Valve Cover Gasket	Pcs.	
926.080	906 016 06 21	Valve Cover Gasket	Pcs.	
906.085	906 016 07 21	Valve Cover	Pcs.	
926.085	906 016 04 21	Valve Cover	Pcs.	
906.086	000 018 01 33	Valve Cover Diaphragm Gasket	Pcs.	
906.087	000 016 00 40	Valve Cover Gasket	Pcs.	
904.010	904 016 14 23	Gasket	Pcs.	
906.112	906 015 01 80	Flywheel Rear Gasket	Pcs.	
906.115	945 261 00 80	PTO Gasket (Nbr)	Pcs.	
904.131	906 201 00 80	Water Pump Gasket	Pcs.	
906.150	904 141 02 80	Intake Manifold Gasket	Pcs.	
904.150-2	906 141 01 80	Intake Manifold Gasket	Pcs.	
904.150-1	906 141 01 80	Intake Manifold Gasket (Nbr Metal)	Pcs.	
906.160	906 142 02 80	Exhaust Manifold Gasket	Pcs.	
906.161	906 142 02 80	Exhaust Manifold Gasket	Pcs.	
926.160	906 142 02 80	Exhaust Manifold Gasket	Pcs.	
906.165	904 990 04 12	Exhaust Manifold Gasket	Pcs.	
906.180		Gasket	Pcs.	
906.182		Poria Stamp	Pcs.	
906.190-1	906 191 03 80	Gasket (Nbr Metal)	Pcs.	
906.210	906 184 02 80	Oil Filter Gasket	Pcs.	
906.211	002 094 15 80	Gasket	Pcs.	
904.260	906 203 01 76	Thermostat Gasket	Pcs.	
906.260	906 203 01 80	Gasket (Aluminum)	Pcs.	
904.261		Thermostat O-ring	Pcs.	
906.261		Thermostat Gasket	Pcs.	
904.404		Gasket (Nbr Metal)	Pcs.	
906.501	906 142 01 80	Turbo Gasket	Pcs.	
906.603	021 997 84 48	Turbo O-ring Fkm	Pcs.	
501.604	541 997 06 45	Injektör O-ring (11x 3)	Pcs.	
906.604		Pumo O-ring (Viton)	Pcs.	
906.605	027 997 83 48	Pump O-ring (Viton)	Pcs.	
906.606		O-ring (9 x 2,5)	Pcs.	
906.608		Oring	Pcs.	
906-403		Gasket	Pcs.	
906.0480	906 203 04 80	Gasket	Pcs.	
906.0660	906 017 0660	Injektör Stamp	Pcs.	
501.0745	541 997 07 45	Oring (25 x 3,70 / Atego-Axor-Actros)	Pcs.	



Dortrenk Turizm Gayr. Mot.Tas.San. ve Tic. Ltd.Şti.
Tax Administration & No:
 Ikitelli / 313 058 5172
Adress :
 Ikitelli O.S.B Dolapdere Sanayi Sitesi 12.Ada No:56
 Basaksehir / Istanbul / Turkiye
Tel :+90 (212) 243 02 03 Fax: +90 (212) 355 02 42
Email: bilgi@otobusyedekparca.com

01-2017

For Mercedes.Benz	OM 934 LA EURO 6 ATEGO 156-231 HP 4 CYL.L - Ø110 mm		
			
934.050	934.080	934.155	934.060
			
936.160	936.162	936.161	

For Mercedes.Benz	OM 936 LA EURO 6 ATEGO 238-354 HP 6 CYL.L - Ø110 mm				
					
936.050	936.060	936.063	936.080		
					
936.070	936.113	936.155		936.080-1	
					
936.160	936.161	936.162	936.134	936.301	
					
936.131	936.210	936.1045	936.073	936.154	
					
936.156	936.157	936.114	936.0680	936.0080	936.0280



Dortrenk Turizm Gayr. Mot.Tas.San. ve Tic. Ltd.Şti.
Tax Administration & No:
 Ikitelli / 313 058 5172
Address :
 Ikitelli O.S.B Dolapdere Sanayi Sitesi 12.Ada No:56
 Basaksehir / Istanbul / Turkiye
Tel :+90 (212) 243 02 03 Fax: +90 (212) 355 02 42
Email: bilgi@otobusyedekparca.com

01-2017

For Mercedes.Benz		OM 934 LA EURO 6 ATEGO 156-231 HP 4 CYL.L - Ø110 mm		
Imsp Ref.	Orj. Ref.	DESCRIPTION	Unit	
934.050		Cylinder Cover Gasket	Pcs.	
934.060		Oil Pan Gasket	Pcs.	
934.155		Gasket	Pcs.	
934.080		Valve Cover Gasket	Pcs.	
936.160		Exhaust Manifold Gasket	Pcs.	
936.161		Exhaust Manifold Gasket	Pcs.	
936.162		Exhaust Manifold Gasket	Pcs.	

For Mercedes.Benz		OM 936 LA EURO 6 ATEGO 238-354 HP 6 CYL.L- Ø110 mm		
Imsp Ref.	Orj. Ref.	DESCRIPTION	Unit	
936.050		Cylinder Cover Gasket	Pcs.	
936.060		Oil Pan Gasket	Pcs.	
936.063		Oil Pan Gasket	Pcs.	
936.070		Oil Radiator Gasket	Pcs.	
936.070-1		Oil Radiator Gasket (Nbr-Metal)	Pcs.	
936.073		Gasket	Pcs.	
936.080		Valve Cover Gasket	Pcs.	
936.080-1		Valve Cover Gasket (Nbr-Metal)	Pcs.	
936.113		Gasket	Pcs.	
936.114		Gasket	Pcs.	
936.131		Water Pump Gasket	Pcs.	
936.134		Gasket	Pcs.	
936.154		Gasket	Pcs.	
936.155		Gasket	Pcs.	
936.156		Gasket	Pcs.	
936.157		Gasket	Pcs.	
936.160		Exhaust Manifold Gasket	Pcs.	
936.161		Exhaust Manifold Gasket	Pcs.	
936.162		Exhaust Manifold Gasket	Pcs.	
936.210		Oil Filter Billet Gasket	Pcs.	
936.301		Gasket	Pcs.	
936.0680		Water Pump Gasket	Pcs.	
936.0280		Water Pump Gasket	Pcs.	
936.0080		Oil Radiator Gasket	Pcs.	
936.1045		Oil Pan Gasket	Pcs.	



Dortrenk Turizm Gayr. Mot.Tas.San. ve Tic. Ltd.Şti.

Tax Administration & No:

Ikitelli / 313 058 5172

Adress :

Ikitelli O.S.B Dolapdere Sanayi Sitesi 12.Ada No:56

Basaksehir / Istanbul / Turkiye

Tel :+90 (212) 243 02 03 Fax: +90 (212) 355 02 42

Email: bilgi@otobusyedekparca.com

01-2017



Dortrenk Turizm Gayr. Mot.Tas.San. ve Tic. Ltd.Şti.

Tax Administration & No:

Ikitelli / 313 058 5172

Adress :

Ikitelli O.S.B Dolapdere Sanayi Sitesi 12.Ada No:56

Basaksehir / Istanbul / Turkiye

Tel :+90 (212) 243 02 03 Fax: +90 (212) 355 02 42

Email: bilgi@otobusyedekparca.com

01-2017

NAVAL - MARINE
&
MAN
DYAMOND
&
MERCEDES
&
ENGINE SPARE PARTS

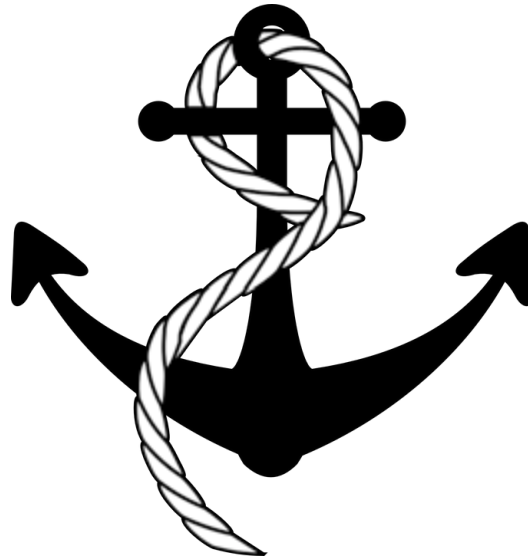



Dortrenk Turizm Gayr. Mot.Tas.San. ve Tic. Ltd.Şti.

Tax Administration & No:

Ikitelli / 313 058 5172

Adress :

Ikitelli O.S.B Dolapdere Sanayi Sitesi 12.Ada No:56

Basaksehir / Istanbul / Turkiye

Tel :+90 (212) 243 02 03 Fax: +90 (212) 355 02 42

Email: bilgi@otobusyedekparca.com

01-2017

SECTION



Dortrenk Turizm Gayr. Mot.Tas.San. ve Tic. Ltd.Şti.
Tax Administration & No:
 Ikitelli / 313 058 5172
Adress :
 Ikitelli O.S.B Dolapdere Sanayi Sitesi 12.Ada No:56
 Basaksehir / Istanbul / Turkiye
Tel :+90 (212) 243 02 03 Fax: +90 (212) 355 02 42
Email: bilgi@otobusyedekparca.com

01-2017

For Mercedes		OM.404. V/12 MARINE			
441.050 Ø128	404.060	444.791	421.070	444.081	280.081
404.070	404.071	404.072	404.074.1	404.074	
444.131	404.131	2842.131	404.260	404.098	444.099
365x160	444.096	363x160	310x160	305x15	
444.095	444.096	444.094	444.097	404.099	
317x145	360x160	365x160	2842.092	305x15	
404.096	404.097	444.098	2842.092	404.092	
525x137	457x175	404.490	2842.091	404.075	
444.090	2842.090	404.490	2842.091	404.075	
520x135	520x135	525x160	525x160		
404.093	444.091	444.092	444.093		



Dortrenk Turizm Gayr. Mot.Tas.San. ve Tic. Ltd.Şti.

Tax Administration & No:

Ikitelli / 313 058 5172

Adress :

Ikitelli O.S.B Dolapdere Sanayi Sitesi 12.Ada No:56
Basaksehir / Istanbul / Turkiye

Tel :+90 (212) 243 02 03 Fax: +90 (212) 355 02 42

Email: bilgi@otobusyedekparca.com

01-2017



Dortrenk Turizm Gayr. Mot.Tas.San. ve Tic. Ltd.Şti.
Tax Administration & No:
 Ikitelli / 313 058 5172
Address :
 Ikitelli O.S.B Dolapdere Sanayi Sitesi 12.Ada No:56
 Basaksehir / Istanbul / Turkiye
Tel :+90 (212) 243 02 03 Fax: +90 (212) 355 02 42
Email:bilgi@otobusyedekparca.com

01-2017

For Mercedes Benz		OM-404-444 V/12 MARINE		
IMSP	Orj. Ref.	DESCRIPTION	Unit	
444.100		V/12 MARINE Full Set Gasket (128.Ø)	Set.	
444.100.1		V/12 MARINE Full Set Gasket (128.Ø Orj.)	Set.	
444.102		V/12 MARINE Half Set Gasket	Set.	
444.105		Full Set Gasket (Cylinder Cover Excluded) V/12 MARINE	Set.	
441.050	442 016 04 20	Cylinder Gasket (125Ø Rubber) elring no:412.180	Pcs.	
442.050	442 016 06 20	Cylinder Gasket (128Ø Rubber) elring no:896.510	Pcs.	
404.060	444 014 00 22	Oil Pan Gasket V/12 51 0590 40133	Pcs.	
444.061		Oil Pan Gasket (24 Cyl)	Pcs.	
404.070		Gasket 51.05902.0048	Pcs.	
421.070	442 188 05 80	Oil Radiator Gasket	Pcs.	
404.071		Gasket	Pcs.	
404.072		Gasket	Pcs.	
404.074		Oil Radiator Gasket (Old Model)	Pcs.	
404.074.2		Oil Radiator Gasket	Pcs.	
404.075		Rubber (MTU)	Pcs.	
444.081		Valve Cover Gasket	Pcs.	
280.081		Valve Cover Gasket (Silicone)	Pcs.	
444.090		Cooler Gasket Klingrite	Pcs.	
444.090.2		Cooler Gasket Klingrite (Wired)	Pcs.	
444.091		Cooler Gasket Klingrite	Pcs.	
444.091.2		Cooler Gasket Klingrite (Wired)	Pcs.	
404.092		Cooler Gasket	Pcs.	
444.092		Cooler Gasket Klingrite	Pcs.	
444.092.2		Cooler Gasket Klingrite (Wired)	Pcs.	
404.093		Cooler Gasket	Pcs.	
444.093		Cooler Gasket Klingrite	Pcs.	
444.093.2		Cooler Gasket Klingrite (Wired)	Pcs.	
444.094		Cooler Gasket Klingrite	Pcs.	
444.094.2		Cooler Gasket Klingrite (Wired)	Pcs.	
444.095		Cooler Gasket Klingrite	Pcs.	
444.095.2		Cooler Gasket Klingrite (Wired)	Pcs.	
404.096		Cooler Gasket Klingrite	Pcs.	
444.096		Cooler Gasket Klingrite	Pcs.	
444.096.2		Cooler Gasket Klingrite (Wired)	Pcs.	
404.097		Cooler Gasket Klingrite	Pcs.	
444.097		Cooler Gasket Klingrite	Pcs.	
444.097.2		Cooler Gasket Klingrite (Wired)	Pcs.	
404.098		Cooler Gasket Klingrite	Pcs.	
404.098.2		Cooler Gasket Klingrite (Wired)	Pcs.	
444.098		Cooler Gasket Klingrite	Pcs.	
444.098.2		Cooler Gasket Klingrite (Wired)	Pcs.	
404.099		Cooler Gasket	Pcs.	
444.099		Cooler Gasket Klingrite	Pcs.	
444.099.2		Cooler Gasket Klingrite (Wired)	Pcs.	
404.131		Water Pump Gasket	Pcs.	
444.131		Water Pump Gasket	Pcs.	
2842.131		Water Pump Gasket	Pcs.	
404.260		Thermostat Gasket	Pcs.	
404.490		Intercol Gasket	Pcs.	
444.791		Fuel Pump Gasket	Pcs.	
2842.092		Gasket	Pcs.	
2842.090		Gasket	Pcs.	
2842.091		Gasket	Pcs.	
444.190.2		Gasket	Pcs.	



Dortrenk Turizm Gayr. Mot.Tas.San. ve Tic. Ltd.Şti.

Tax Administration & No:

Ikitelli / 313 058 5172

Adress :

Ikitelli O.S.B Dolapdere Sanayi Sitesi 12.Ada No:56
Basaksehir / Istanbul / Turkiye

Tel :+90 (212) 243 02 03 Fax: +90 (212) 355 02 42

Email: bilgi@otobusyedekparca.com

01-2017



Dortrenk Turizm Gayr. Mot.Tas.San. ve Tic. Ltd.Şti.
Tax Administration & No:
 Ikitelli / 313 058 5172
Adress :
 Ikitelli O.S.B Dolapdere Sanayi Sitesi 12.Ada No:56
 Basaksehir / Istanbul / Turkiye
Tel :+90 (212) 243 02 03 Fax: +90 (212) 355 02 42
Email: bilgi@otobusyedeckparca.com

01-2017

For Mercedes		OM.404. V/12 MARINE			
421.150	404.151	2842.150	404.150	404.152	444.301
401.160	401.160-3	444.160	444.161	444.162	404.170
444.170	444.171	404.501	444.501	404.502	2842.506
444.502	444.503	404.503	444.449	2842.301	2842.300
280.068	444.302	404.022	404.073	2842.400	404.203
444.073	444.190				



Dortrenk Turizm Gayr. Mot.Tas.San. ve Tic. Ltd.Şti.
Tax Administration & No:
 Ikitelli / 313 058 5172
Address :
 Ikitelli O.S.B Dolapdere Sanayi Sitesi 12.Ada No:56
 Basaksehir / Istanbul / Turkiye
Tel :+90 (212) 243 02 03 Fax: +90 (212) 355 02 42
Email: bilgi@otobusyedekparca.com

01-2017

For Mercedes Benz		OM-404-444 V/12 MARINE		
IMSP	Orj. Ref.	DESCRIPTION	Unit	
421.150		Intake Manifold Gasket	Pcs.	
404.150		Intake Manifold Gasket	Pcs.	
2842.150		Exhaust Gasket	Pcs.	
404.151		Intake Manifold Gasket (2,5mm)	Pcs.	
404.152		Intake Manifold Gasket	Pcs.	
401.160	403 142 03 80	Exhaust Manifold Gasket	Pcs.	
401.160-3		Exhaust Manifold Gasket (Graphite)	Pcs.	
444.160		Exhaust Manifold Gasket	Pcs.	
444.161		Exhaust Manifold Gasket (New Model)	Pcs.	
444.162		Exhaust Pipe Gasket	Pcs.	
404.170		Exhaust Manifold	Pcs.	
444.170		Exhaust Pipe Gasket	Pcs.	
444.171		Exhaust Pipe Gasket	Pcs.	
444.501		Turbine Gasket	Pcs.	
404.501		Turbine Gasket	Pcs.	
404.502		Turbine Gasket	Pcs.	
444.502		Turbine Gasket	Pcs.	
444.503		Turbine Gasket	Pcs.	
404.503		Turbine Gasket	Pcs.	
2842.506		Gasket	Pcs.	
444.449		Gasket	Pcs.	
280.068		Gasket	Pcs.	
444.302		Gasket	Pcs.	
404.022		Gasket	Pcs.	
404.073		Oil Filter Billet Gasket	Pcs.	
444.073		Oil Filter Billet Gasket	Pcs.	
2842.400		Gasket	Pcs.	
404.203		Water Pump Gasket	Pcs.	
2842.301		Gasket	Pcs.	
2842.300		Gasket	Pcs.	
444.301		Cooler Side Gasket	Pcs.	



Dortrenk Turizm Gayr. Mot.Tas.San. ve Tic. Ltd.Şti.

Tax Administration & No:

Ikitelli / 313 058 5172

Adress :

Ikitelli O.S.B Dolapdere Sanayi Sitesi 12.Ada No:56

Basaksehir / Istanbul / Turkiye

Tel :+90 (212) 243 02 03 Fax: +90 (212) 355 02 42

Email: bilgi@otobusyedekparca.com

01-2017



Dortrenk Turizm Gayr. Mot.Tas.San. ve Tic. Ltd.Şti.

Tax Administration & No:

Ikitelli / 313 058 5172

Adress :

Ikitelli O.S.B Dolapdere Sanayi Sitesi 12.Ada No:56

Basaksehir / Istanbul / Turkiye

Tel :+90 (212) 243 02 03 Fax: +90 (212) 355 02 42

Email: bilgi@otobusyedekparca.com

01-2017

MAN ENGINE GASKET



SECTION



Dortrenk Turizm Gayr. Mot.Tas.San. ve Tic. Ltd.Şti.

Tax Administration & No:

Ikitelli / 313 058 5172

Adress :

Ikitelli O.S.B Dolapdere Sanayi Sitesi 12.Ada No:56
Basaksehir / Istanbul / Turkiye

Tel :+90 (212) 243 02 03 Fax: +90 (212) 355 02 42

Email: bilgi@otobusyedekparca.com

01-2017



Dortrenk Turizm Gayr. Mot.Tas.San. ve Tic. Ltd.Şti.
Tax Administration & No:
 Ikitelli / 313 058 5172
Adress :
 Ikitelli O.S.B Dolapdere Sanayi Sitesi 12.Ada No:56
 Basaksehir / Istanbul / Turkiye
Tel :+90 (212) 243 02 03 Fax: +90 (212) 355 02 42
Email: bilgi@otobusyedekparca.com

01-2017

FOR MAN		D.0224(0824) D. (12.153)			
0824.050	0836.050	0224.101	0824.101	0824.060	
0826.109	0826.011	0824.112	0824.010	0826.010	
0826.070	0826.080	0824.131	0826.131	0826.013	
0826.150	0826.160	366.501	366.502	366.500	0826.089
0826.069	0826.239	0826.068	0826.234	0826.203	
0826.155	0826.260	0826.251	0826.014	0826.235	401.504
0826.243	0826.236	0826.237	0826.240	401.505	



Dortrenk Turizm Gayr. Mot.Tas.San. ve Tic. Ltd.Şti.
Tax Administration & No:
 Ikitelli / 313 058 5172
Address :
 Ikitelli O.S.B Dolapdere Sanayi Sitesi 12.Ada No:56
 Basaksehir / Istanbul / Turkiye
Tel :+90 (212) 243 02 03 Fax: +90 (212) 355 02 42
Email: bilgi@otobusyedekparca.com

01-2017

FOR MAN		D-0224(0824) D- (12.153)		
IMSP Ref	ORJ. REF.	DESCRIPTION	Unit	
0224.100		Full Set Gasket (102,Ø 4 CYL)	Set.	
0824.100		Full Set Gasket (108,Ø 4 CYL)	Set.	
0824.100-1		Full Set Gasket (108,Ø 4 CYL) Orj.	Set.	
0824.101		Cylinder Head Gasket (102Ø)	Set.	
0826.101		Cylinder Head Gasket (108Ø)	Set.	
0826.101-1	51 00900 66 28	Cylinder Head Gasket (108Ø Orj.)	Set.	
0824.102		Half Set Gasket	Set.	
0824.104		Half Set Gasket (Rubber/Stamp)	Set.	
0824.105		Full Set Gasket (Cylinder Cover Excluded)	Set.	
0824.050	51 03901 0379	Cylinder Gasket (102 Ø)	Pcs.	
0836.050	51 03901 0379	Cylinder Gasket (108 Ø)	Pcs.	
0824.060	51 05904 0171	Oil pan Gasket (4 CYL)	Pcs.	
0826.070	51 05901 0102	Gasket	Pcs.	
0826.080	51 03905 0155	Valve Cover Gasket	Set.	
0836.080	51 03905 0155	Valve Cover Gasket (Nbr Metal)	Set.	
0826.086	51 96601 0474	Valve Cover Gasket	Pcs.	
0826.089		Valve Cover Gasket	Pcs.	
0826.010	51 01903 0305	Eccentric Cover Gasket (Klingrite)	Pcs.	
0826.010-2	51 01903 0305	Eccentric Cover Gasket (Wired-Klingrite)	Pcs.	
0824.010	51 01903 0297	Front Cover Gasket (Klingrite)	Pcs.	
0824.010-2	51 01903 0297	Front Cover Gasket (Wired-Klingrite)	Pcs.	
0826.011	51 01903 0246	Eccentric Cover Gasket (Klingrite)	Pcs.	
0826.011-2	51 01903 0246	Eccentric Cover Gasket (Wired-Klingrite)	Pcs.	
0826.013		Gasket	Pcs.	
0826.014	51 01903 0295	Gasket	Pcs.	
0826.068		Gasket	Pcs.	
0826.069		Gasket	Pcs.	
0826.109-2		Eccentric Cover Gasket Set (Wired/Klingrite)	Pcs.	
0824.112	51 01903 0273	Flywheel Rear Gasket	Pcs.	
0824.131	51 06901 0119	Water Pump Gasket	Pcs.	
0826.131	51 06901 0119	Water Pump Gasket	Pcs.	
0826.150	51 08902 0179	Intake Manifold Gasket	Pcs.	
0826.155	51 08902 0139	Gasket	Pcs.	
0826.160	51 08901 0027	Exhaust Manifold Gasket	Pcs.	
0826.203	51 06903 0030	Water Pump Gasket (Klingrite)	Pcs.	
0826.203-2	51 06903 0030	Water Pump Gasket (Wired/Klingrite)	Pcs.	
0826.236	06 56259 0033	Oil Pan Gasket	Pcs.	
280.601		Gasket	Pcs.	
280.602		Gasket	Pcs.	
366.500		Turbo Set Gasket	Set.	
366.501	51 09901 0051	Turbo Gasket	Pcs.	
366.502	51 09901 0036	Turbo Gasket	Pcs.	



Dortrenk Turizm Gayr. Mot.Tas.San. ve Tic. Ltd.Şti.
Tax Administration & No:
 Ikitelli / 313 058 5172
Address :
 Ikitelli O.S.B Dolapdere Sanayi Sitesi 12.Ada No:56
 Basaksehir / Istanbul / Turkiye
Tel :+90 (212) 243 02 03 Fax: +90 (212) 355 02 42
Email: bilgi@otobusyedekparca.com

01-2017

FOR MAN		D.(0226.0826)		SL.(232.222.26.230.26.270)		
0824.050	0836.050	0224.101	0824.101	0826.060		
0826.109	0826.011	0824.112	0826.010	0826.112		
0826.070	0826.080	0826.131	0826.132	0826.131.1		
0826.155	0826.234	0826.260	0826.013	280.601	280.602	0826.089
0826.203	0826.069	0826.150	0826.160	366.501	366.502	366.500
0826.014	0826.251	0826.235	0826.239	0826.068	401.504	401.505
0826.243	0826.236	0826.237	0826.240			



Dortrenk Turizm Gayr. Mot.Tas.San. ve Tic. Ltd.Şti.
Tax Administration & No:
 Ikitelli / 313 058 5172
Address :
 Ikitelli O.S.B Dolapdere Sanayi Sitesi 12.Ada No:56
 Basaksehir / Istanbul / Turkiye
Tel :+90 (212) 243 02 03 Fax: +90 (212) 355 02 42
Email:bilgi@otobusyedekparca.com

01-2017

For MAN		D-(0226-0826) SL-(232.222-26.230-26.270)		
IMSP Ref	ORJ. REF.	DESCRIPTION	Unit	
0826.100		Full Set Gasket (108Ø 6 Cyl.)	Set.	
0826.100-1		Full Set Gasket (108Ø 6 Cyl.)	Set.	
0824.101		Cylinder Head Gasket (102Ø)	Set.	
0826.101		Cylinder Head Gasket (108Ø)	Set.	
0826.101-1	51 00900 66 28	Cylinder Head Gasket (108Ø Orj.)	Set.	
0826.102		Half Set Gasket	Set.	
0826.104		Half Set Gasket (Rubber/Stamp)	Set.	
0826.105		Full Set Gasket (Cylinder Cover Excluded)	Set.	
0824.050	51 03901 0379	Cylinder Gasket (102 Ø)	Pcs.	
0836.050	51 03901 0379	Cylinder Gasket (108 Ø)	Pcs.	
0826.060	51 05904 0139	Oil Pan Gasket (6 CYL)	Pcs.	
0826.070	51 05901 0102	Gasket	Pcs.	
0826.080	51 03905 0155	Valve Cover Gasket	Set.	
0836.080	51 03905 0155	Valve Cover Gasket	Set.	
0826.086	51 96601 0474	Valve Cover Gasket	Pcs.	
0826.089		Valve Cover Gasket	Pcs.	
0826.010	51 01903 0305	Eccentric Cover Gasket (Klingrite)	Pcs.	
0826.010-2	51 01903 0305	Eccentric Cover Gasket (Wired/Klingrite)	Pcs.	
0824.010	51 01903 0297	Front Cover Gasket (Klingrite)	Pcs.	
0824.010-2	51 01903 0297	Front Cover Gasket (Wired/Klingrite)	Pcs.	
0826.011	51 01903 0246	Eccentric Cover Gasket (Klingrite)	Pcs.	
0826.011-2	51 01903 0246	Eccentric Cover Gasket (Wired/Klingrite)	Pcs.	
0826.013	51 01903 0295	Gasket	Pcs.	
0826.014	51 01903 0294	Gasket	Pcs.	
0826.068		Gasket	Pcs.	
0826.069		Gasket	Pcs.	
0826.109-2		Eccentric Cover Gasket Set (Wired/Klingrite)	Pcs.	
0824.112	51 01903 0273	Flywheel Rear Gasket	Pcs.	
0826.112	51 01903 0273	Flywheel Rear Gasket	Pcs.	
0824.131	51 06901 0119	Water Pump Gasket	Pcs.	
0826.131	51 06901 0119	Water Pump In Gasket	Pcs.	
0826.132	51 06901 0119	Water Pump Outer Gasket	Pcs.	
0826.150	51 06901 0118	Intake Manifold Gasket	Pcs.	
0826.151	51 08902 0179	Intake Manifold Gasket (Aluminum)	Pcs.	
0826.155	51 08902 0179	Gasket	Pcs.	
0826.160	51 08902 0139	Exhaust Manifold Gasket	Pcs.	
0826.203	51 08901 0027	Gasket	Pcs.	
0826.203-2	51 06903 0030	Water Pump	Pcs.	
0826.236	51 06903 0030	Oil Pan Gasket	Pcs.	
280.601	06 56259 0033	Gasket	Pcs.	
280.602		Gasket	Pcs.	
366.500		Turbo Set Gasket	Set.	
366.501		Turbo Gasket	Pcs.	
366.502	51 09901 0051	Turbo Gasket	Pcs.	



Dortrenk Turizm Gayr. Mot.Tas.San. ve Tic. Ltd.Şti.
Tax Administration & No:
 Ikitelli / 313 058 5172
Adress :
 Ikitelli O.S.B Dolapdere Sanayi Sitesi 12.Ada No:56
 Basaksehir / Istanbul / Turkiye
Tel :+90 (212) 243 02 03 Fax: +90 (212) 355 02 42
Email: bilgi@otobusyedekparca.com

01-2017

FOR MAN	MAN 12.163 D0834 TEMSA POWER BUS					
0824.050	0836.050	0224.101	0824.101	0834.060		
0836.010	0836.011	0824.112	0826.112	0824.060		
0834.070	0836.070	0826.080	0834.071	0836.131	0826.013	0826.089
0826.203	0826.260	0826.251	0826.234	0826.235	0826.069	0836.014
0826.155	0826.150	0826.160	366.501	366.502	366.500	401.504
0826.239	0826.068	0826.243	0826.236	0826.237	0826.240	401.505



Dortrenk Turizm Gayr. Mot.Tas.San. ve Tic. Ltd.Şti.
Tax Administration & No:
 İkitelli / 313 058 5172
Address :
 İkitelli O.S.B Dolapdere Sanayi Sitesi 12.Ada No:56
 Basaksehir / Istanbul / Turkiye
Tel :+90 (212) 243 02 03 Fax: +90 (212) 355 02 42
Email:bilgi@otobusyedekparca.com

01-2017

For MAN		MAN-(12.163) D-(0834) (TEMSA POWER BUS)		
IMSP Ref	ORJ. REF.	DESCRIPTION	Unit	
0834.100		Full Set Gasket (108Ø /12.163)	Set.	
0834.100-1		Full Set Gasket (108Ø /12.163 Orj.)	Set.	
0834.100-2		Full Set Gasket (108Ø Power Bus)	Set.	
0834.100-3		Full Set Gasket (108Ø Power Bus Orj)	Set.	
0826.101		Cylinder Head Gasket (108Ø)	Set.	
0826.101-1	51 00900 66 28	Cylinder Head Gasket (108Ø Orj.)	Set.	
0834.102		Half Set Gasket	Set.	
0834.104		Half Set Gasket (Rubber/Stamp)	Set.	
0834.105		Full Set Gasket (Cylinder Cover Excluded)	Set.	
0834.102-1		Half Set Gasket (Klingrite) Power Bus	Set.	
0834.104-1		Half Set Gasket (Rubber/Stamp) Power Bus (Klingrite)	Set.	
0834.105-1		Full Set Gasket (Cylinder Cover Excluded) Power Bus (Klingrite)	Set.	
0836.050	51 03901 0379	Cylinder Gasket (108.Ø)	Pcs.	
0824.060	51 05904 0171	Oil Pan Gasket (4 CYL)	Pcs.	
0834.060	51 05904 0197	Oil Pan Gasket (4 CYL)	Pcs.	
0834.070	51 05901 0102	Oil Radiator Gasket (12.180)	Pcs.	
0836.070		Gasket	Pcs.	
0836.070-1	51 05901 0102	Gasket (Nbr Metal)	Pcs.	
0834.071		Oil Filter Gasket	Pcs.	
0826.080	51 039050 155	Valve Cover Gasket	Set.	
0836.080	51 03905 0155	Valve Cover Gasket (Nbr Metal)	Set.	
0826.083	51 03905 0155	Gasket	Pcs.	
0826.086	51 96601 0474	Valve Cover Gasket	Pcs.	
0826.089		Gasket	Pcs.	
0836.010	51 01903 0305	Front Cover Gasket (Wired Klingrite)	Pcs.	
0836.010-1	51 01903 0305	Front Cover Gasket (Orj. Nbr Metal)	Pcs.	
0836.011	51 01903 0246	Eccentric Cover Gasket (Outer Klingrite)	Pcs.	
0836.011-2	51 01903 0246	Eccentric Cover Gasket (Wired/Klingrite)	Pcs.	
0826.013	51 01903 0295	Gasket	Pcs.	
0836.014	51 01903 0294	Gasket	Pcs.	
0824.112	51 01903 0273	Flywheel Rear Gasket	Pcs.	
0824.112-2	51 01903 0273	Flywheel Rear Gasket (Wired Klingrite)	Pcs.	
0826.112	51 01903 0273	Flywheel Rear Gasket	Pcs.	
0826.112-2	51 01903 0273	Flywheel Rear Gasket (Wired Klingrite)	Pcs.	
0836.131	51 01901 0119	Water Pump Gasket	Pcs.	
0826.132	51 01901 0118	Water Pump Gasket	Pcs.	
0826.150	51 08902 0179	Intake Manifold Gasket	Pcs.	
0826.151	51 08902 0179	Intake Manifold Gasket (Aluminum)	Pcs.	
0826.155	51 08902 0139	Gasket	Pcs.	
0826.160	51 08901 0027	Exhaust Manifold Gasket	Pcs.	
0826.203	51 06903 0030	Water Pump Gasket (Klingrite)	Pcs.	
0826.203-2	51 06903 0030	Water Pump Gasket (Wired Klingrite)	Pcs.	
0826.236	06 56259 0033	Oil Pan Gasket	Pcs.	
0826.240	51 96601 0546	Gasket	Pcs.	
0826.241		Gasket	Pcs.	
0826.260	51 06904 023	Thermostat Gasket	Pcs.	
366.500		Turbo Set Gasket	Set.	
366.501	51 09901 0051	Turbo Gasket	Pcs.	
366.502	51 09901 0036	Turbo Gasket	Pcs.	



Dortrenk Turizm Gayr. Mot.Tas.San. ve Tic. Ltd.Şti.
Tax Administration & No:
 Ikitelli / 313 058 5172
Adress :
 Ikitelli O.S.B Dolapdere Sanayi Sitesi 12.Ada No:56
 Basaksehir / Istanbul / Turkiye
Tel :+90 (212) 243 02 03 Fax: +90 (212) 355 02 42
Email: bilgi@otobusyedekparca.com

01-2017

FOR MAN	MAN 32.270 / D.0836 AS HIEX COBRA – TEZELLER					
0824.050	0836.050	0224.101	0824.101	0836.060		
0836.010	0836.011	0836.112	0826.112	0826.060		
0834.070	0836.070	0826.080	0824.112	0834.071	0836.131	
0826.089	0826.013	0826.089	0826.203	0826.260	0826.251	0826.234
0826.235	0826.069	0836.014	0826.239	0826.068	0826.243	0826.236
0826.155	0826.150	0826.160	366.501	366.502	366.500	401.504
0826.237	0826.240	401.505				



Dortrenk Turizm Gayr. Mot.Tas.San. ve Tic. Ltd.Şti.
Tax Administration & No:
 Ikitelli / 313 058 5172
Address :
 Ikitelli O.S.B Dolapdere Sanayi Sitesi 12.Ada No:56
 Basaksehir / Istanbul / Turkiye
Tel :+90 (212) 243 02 03 Fax: +90 (212) 355 02 42
Email:bilgi@otobusyedekparca.com



















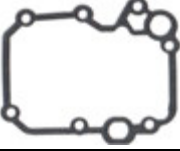

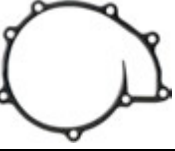
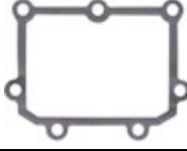









01-2017

For MAN		MAN-(32.270) / D-0836 (AS – HIEX – COBRA- TEZELLER)		
IMSP Ref	ORJ. REF.	DESCRIPTION	Unit	
0836.100		Full Set Gasket (108Ø 32.270)	Set.	
0836.100-1		Full Set Gasket (108Ø 32.270/ Orj.)	Set.	
0836.100-2		Full Set Gasket (108Ø Power Bus)	Set.	
0836.100-3		Full Set Gasket (108Ø Power Bus Orj.)	Set.	
0826.101		Cylinder Head Gasket (108Ø)	Set.	
0826.101-1	51 00900 66 28	Cylinder Head Gasket (108Ø)	Set.	
0836.102		Half Set Gasket	Set.	
0836.104		Half Set Gasket (Rubber/Stamp)	Set.	
0836.105		Full Set Gasket (Cylinder Cover Excluded)	Set.	
0836.102-1		Half Set Gasket (Tezeller / Cobra / Bus)	Set.	
0836.104-1		Half Set Gasket (Rubber/Stamp)	Set.	
0836.105-1		Full Set Gasket (Cylinder Cover Excluded) (Cobra/Tezeller)	Set.	
0836.050	51 03901 0379	Cylinder Gasket-(108Ø	Pcs.	
0836.060	51 05904 0195	Oil Pan Gasket	Pcs.	
0826.060	51 05904 0139	Oil Pan Gasket (6 CYL)	Pcs.	
0834.070	51 05901 0102	Oil Radiator Gasket (12.180)	Pcs.	
0836.070		Gasket	Pcs.	
0836.070-1	51 05901 0102	Gasket (Nbr Metal)	Pcs.	
0834.071		Oil Filter Gasket	Pcs.	
0826.080	51 03905 0155	Valve Cover Gasket	Pcs.	
0836.080	51 03905 0155	Valve Cover Gasket	Pcs.	
0826.083	51 03905 0155	Gasket	Pcs.	
0826.086	51 96601 0474	Valve Cover Gasket	Pcs.	
0826.089		Gasket	Pcs.	
0836.010	51 01903 0305	Gasket	Pcs.	
0836.010-1	51 01903 0305	Gasket (Nbr Metal)	Pcs.	
0836.011	51 01903 0246	Eccentric Cover Gasket (Outer Klingrite)	Pcs.	
0836.011-2	51 01903 0246	Eccentric Cover Gasket (Wired Klingrite)	Pcs.	
0826.013	51 01903 0295	Gasket	Pcs.	
0836.014	51 01903 0294	Gasket	Pcs.	
0824.112	51 01903 0273	Flywheel Rear Gasket	Pcs.	
0824.112-2	51 01903 0273	Flywheel Rear Gasket (Wired/Klingrite)	Pcs.	
0836.112-2	51 01903 0243	Flywheel Rear Gasket (Wired/Klingrite)	Pcs.	
0836.112-1	51 01903 0243	Flywheel Rear Gasket (Nbr Metal)	Pcs.	
0826.112	51 01903 0273	Flywheel Rear Gasket	Pcs.	
0836.131	51 01901 0119	Water Pump Gasket	Pcs.	
0826.132	51 01901 0118	Water Pump Gasket	Pcs.	
0826.150	51 08902 0179	Intake Manifold Gasket	Pcs.	
0826.155	51 08902 0139	Gasket	Pcs.	
0826.160	51 08901 0027	Exhaust Manifold Gasket	Pcs.	
0826.203	51 06903 0030	Gasket	Pcs.	
0826.203-2	51 06903 0030	Gasket	Pcs.	
0826.236	06 56259 0033	Oil Pan Gasket	Pcs.	
0826.240	51 96601 0546	Gasket	Pcs.	
0826.241		Gasket	Pcs.	
0826.260	51 06904 023	Thermostat Gasket	Pcs.	
366.500		Turbo Set Gasket	Set.	
366.501	51 09901 0051	Turbo Gasket	Pcs.	
366.502	51 09901 0036	Turbo Gasket	Pcs.	



Dortrenk Turizm Gayr. Mot.Tas.San. ve Tic. Ltd.Şti.
Tax Administration & No:
 Ikitelli / 313 058 5172
Adress :
 Ikitelli O.S.B Dolapdere Sanayi Sitesi 12.Ada No:56
 Basaksehir / Istanbul / Turkiye
Tel :+90 (212) 243 02 03 Fax: +90 (212) 355 02 42
Email: bilgi@otobusyedekparca.com

01-2017

FOR MAN	TEZELLER.GÜLERYÜZ.COBRA EURO 5 MAN.TGL.TGM.12.240 4CYL 6CYL			
				
0836.050	180.101	0834.060	180.080	
				
0836.010	180.011	0824.112	0836.070	0826.112
				
0834.070	0834.071	180.131	181.158	180.155
				
180.150	180.160	180.156	180.501	180.157
				
180.260	180.203	0836.014	180-158	180.159
				
180.156	181-401	181-504	401.504	401.505
				
180-210	366.500	366.501	366.502	



Dortrenk Turizm Gayr. Mot.Tas.San. ve Tic. Ltd.Şti.
Tax Administration & No:
 Ikitelli / 313 058 5172
Address :
 Ikitelli O.S.B Dolapdere Sanayi Sitesi 12.Ada No:56
 Basaksehir / Istanbul / Turkiye
Tel :+90 (212) 243 02 03 Fax: +90 (212) 355 02 42
Email: bilgi@otobusyedekparca.com

01-2017

For MAN		TEZELLER-GÜLERYÜZ-COBRA – (EURO 5) MAN-TGL-TGM-12.240 4.CYL		
IMSP Ref	ORJ. REF.	DESCRIPTION	Unit	
180.100		Full Set Gasket (MAN-12.180-4 CYL)	Set.	
180.100-1		Full Set Gasket (MAN-12.180-4 Orj.Cylinder)	Set.	
180.102		Half Set Gasket	Set.	
180.104		Half Set Gasket (Rubber/Stamp TGL/4Cyl)	Set.	
180.104-1		Half Set Gasket (Rubber/Stamp) (Tezeller/Cobra Euro 4.5/4 Cyl)	Set.	
180.105		Full Set Gasket (Cylinder Cover Excluded)	Set.	
0836.050	51 03901 0379	Cylinder Gasket (108Ø)	Pcs.	
0834.060	51 05904 0197	Oil Pan Gasket (4 CYL)	Pcs.	
0834.070	51 05901 0127	Gasket	Pcs.	
0834.071		Oil Filter Gasket	Pcs.	
0836.070		Oil Radiator Gasket	Pcs.	
180.080	51 03905 0182	Valve Cover Gasket	Pcs.	
0836.010-1	51 01903 0333	Front Gasket (Nbr Metal)	Pcs.	
180.011	51 01903 0328	Eccentric Cover Gasket	Pcs.	
180.011-1	51 01903 0328	Eccentric Cover Gasket (Nbr Metal)	Pcs.	
0836.014	51 01903 0298	Gasket	Pcs.	
0824.112	51 01903 0273	Flywheel Rear Gasket	Pcs.	
0824.112-2	51 01903 0273	Flywheel Rear Gasket	Pcs.	
180.131	51 06901 0196	Water Pump Gasket	Pcs.	
180.131-1		Water Pump Gasket (Nbr Metal)	Pcs.	
180.150	51 08902 0212	Intake Manifold Gasket (Nbr Metal)	Pcs.	
180.155	51 08902 0203	Gasket	Pcs.	
180.156	51 08902 0203	Agr Gasket	Pcs.	
180.157		Gasket	Pcs.	
180.158		Gasket	Pcs.	
180.159		Gasket	Pcs.	
180.160	51 08901 0200	Exhaust Manifold Gasket	Pcs.	
180.203	51 06903 0030	Gasket	Pcs.	
180.210		Water Pump Exit Gasket	Pcs.	
180.210-1		Water Pump Exit Gasket (Nbr Metal)	Pcs.	
180.260	51 06904 0044	Thermostat Gasket (Nbr Metal)	Pcs.	
180.501		Gasket	Pcs.	
181.158		Gasket	Pcs.	
181.401		Gasket	Pcs.	
181.504		Turbine Gasket	Pcs.	
366.500		Turbo Gasket	Set.	
366.501		Turbo Gasket	Pcs.	
366.502		Turbo Gasket	Pcs.	
401.504	442 187 01 80	Turbo Gasket	Pcs.	
401.505	442 187 00 80	Turbo Gasket	Pcs.	



Dortrenk Turizm Gayr. Mot.Tas.San. ve Tic. Ltd.Şti.
Tax Administration & No:
 Ikitelli / 313 058 5172
Adress :
 Ikitelli O.S.B Dolapdere Sanayi Sitesi 12.Ada No:56
 Basaksehir / Istanbul / Turkiye
Tel :+90 (212) 243 02 03 Fax: +90 (212) 355 02 42
Email: bilgi@otobusyedekparca.com

01-2017

FOR MAN		TEZELLER.GÜLERYÜZ.COBRA – EURO 5 MAN.TGL.TGM.12.240 4.CYL 6 CYL			
0836.050	181.101	0836.060		181.080	
0836.010	180.011	0824.112	0826.112	0826.060	
181.156	181-401	0834.070	0836.070	181.158	
180.150	180.160	180.156	180.501	180.157	
180.260	180.203	0836.014	180.158	180.159	
0834.071	180.131	180.155	180-210	366.500	
366.501	366.502	181-504	401.504	401.505	



Dortrenk Turizm Gayr. Mot.Tas.San. ve Tic. Ltd.Şti.
Tax Administration & No:
 Ikitelli / 313 058 5172
Address :
 Ikitelli O.S.B Dolapdere Sanayi Sitesi 12.Ada No:56
 Basaksehir / Istanbul / Turkiye
Tel :+90 (212) 243 02 03 Fax: +90 (212) 355 02 42
Email:bilgi@otobusyedekparca.com

01-2017

For MAN		TEZELLER-GÜLERYÜZ-COBRA – (EURO 5) MAN-TGL-TGM-12.240 6.CYL	
IMSP Ref	ORJ. REF.	DESCRIPTION	Unit
181.100		Full Set Gasket (MAN-12.240-EURO5/6 CYL)	Set.
181.100-1		Full Set Gasket (MAN-12.240-EURO5/6 CYL Orj.)	Set.
181.100-2		Full Set Gasket (MAN- EURO5/6 CYL Tezeller Cobra 0826.060)	Set.
181.100-3		Full Set Gasket (MAN-EURO5/6 CYL Tezeller Cobra 0826.060)	Set.
181.102		Half Set Gasket (TGL 12 240)	Set.
181.104		Half Set Gasket (Rubber/Stamp) (TGL 12,240)	Set.
181.104-1		Half Set Gasket (Rubber/Stamp) (Tezeller/Cobra/Euro 5 0826.060)	Set.
181.105		Full Set Gasket (Cylinder Cover Excluded) (TGL 12.240)	Set.
181.105-1		Full Set Gasket (Cylinder Cover Excluded) Tezeller/Cobra/Euro 4.5/0826.060	Set.
0836.050	51 03901 0379	Cylinder Gasket (108 Ø)	Pcs.
0836.060	51 05904 0195	Oil Pan Gasket	Pcs.
0826.060	51 05904 0139	Oil Pan Gasket (6 CYL)	Pcs.
0826.070		Oil Radiator Gasket	Pcs.
0836.070.2	51 05901 0127	Gasket	Pcs.
0834.071		Oil Filter Gasket	Pcs.
181.080	51 03905 0167	Valve Cover Gasket (6 Cyl)	Pcs.
180.080	51 01903 0333	Valve Cover Gasket	Pcs.
180.081	51 01903 0328	Valve Cover Gasket (6 CYL)	Pcs.
0836.010-1	51 01903 0328	Gasket (Nbr Metal)	Pcs.
180.011	51 01903 0298	Gasket	Pcs.
180.011-1	51 01903 0273	Gasket (Nbr Metal)	Pcs.
0836.014	51 01903 0273	Gasket	Pcs.
0824.112	51 06901 0196	Flywheel Rear Gasket	Pcs.
0824.112-2	51 06901 0196	Flywheel Rear Gasket	Pcs.
180.131	51 08902 0212	Water Pump Gasket	Pcs.
180.131-1	51 08902 0203	Water Pump Gasket (Nbr Metal)	Pcs.
180.150	51 08902 0203	Intake Manifold Gasket (Nbr Metal)	Pcs.
180.155	51 08901 0200	Gasket	Pcs.
180.156	51 06903 0030	Agr Gasket	Pcs.
180.157		Agr Gasket	Pcs.
180.158		Agr Gasket	Pcs.
180.159		Gasket	Pcs.
180.160	51 06904 0044	Exhaust Manifold Gasket	Pcs.
180.203		Gasket	Pcs.
180.210		Water Pump Exit Gasket	Pcs.
180.210-1		Water Pump Exit Gasket (Nbr Metal)	Pcs.
180.260		Thermostat Gasket (Nbr Metal)	Pcs.
180.501		Gasket	Pcs.
181.156		Gasket	Pcs.
181.158		Gasket	Pcs.
181.401		Gasket	Pcs.
181.504		Turbine Gasket	Pcs.
366.500		Turbo Set Gasket	Set.
366.501	442 187 01 80	Turbo Gasket	Pcs.
366.502	442 187 00 80	Turbo Gasket	Pcs.
401.504		Turbo Gasket	Pcs.
401.505	51 03901 0379	Turbo Gasket	Pcs.



Dortrenk Turizm Gayr. Mot.Tas.San. ve Tic. Ltd.Şti.
Tax Administration & No:
 Ikitelli / 313 058 5172
Adress :
 Ikitelli O.S.B Dolapdere Sanayi Sitesi 12.Ada No:56
 Basaksehir / Istanbul / Turkiye
Tel :+90 (212) 243 02 03 Fax: +90 (212) 355 02 42
Email: bilgi@otobusedekparca.com

01-2017

For MAN		D.2066.TGA / 19.430 COMMONRAIL / 18.310.350.390 / LF .01 & 36 / 6.CYL 10.518 CCM Ø120			
2066.050		2066.060		2066.061 (Rubber)	
2066.070		2066.080		2066.010	
2066.131	2066.203	2066.160	2066.161	2066.152	
2066.306.1	2066.155		2066.261	2066.262	
240.501	2066.502	401.505	2066.401.2	2066.407	402.260



Dortrenk Turizm Gayr. Mot.Tas.San. ve Tic. Ltd.Şti.
Tax Administration & No:
 Ikitelli / 313 058 5172
Address :
 Ikitelli O.S.B Dolapdere Sanayi Sitesi 12.Ada No:56
 Basaksehir / Istanbul / Turkiye
Tel :+90 (212) 243 02 03 Fax: +90 (212) 355 02 42
Email: bilgi@otobusyedekparca.com













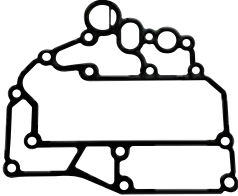
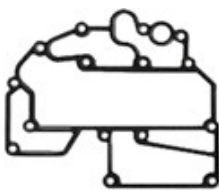









01-2017

For MAN		D.2066.TGA / 19.430 COMMONRAIL / 18.310.350.390 / LF .01 & 36 / 6.CYL 10.518 CCM Ø120 D.2676.TGA / STARLLINER LF.01/05/11/12/13 /14 / LOH 01/02 / 6.CYL 12.412 CCM Ø126		
IMSP Ref	ORJ. REF.	DESCRIPTIPN	Unit	
2066.100	51.00900.6680	Full Set Gasket Ø121 (TGA Truck)	Set.	
2066.100.1	51.00900.6680	Full Set Gasket Ø121 (Orj. TGA Truck)	Set.	
2076.100		Full Set Gasket Ø127 (Bus) (Klingrite)	Set.	
2076.100.1		Full Set Gasket Ø127 (Orj. Bus) (Klingrite)	Set.	
2066.101	51 00900 6681	Cylinder Head Gasket Ø121 (Native SKC)	Set.	
2076.101	51 00900 6681	Cylinder Head Gasket Ø127 (Native SKC)	Set.	
2066.102		Half Set Gasket (Truck)	Set.	
2066.102.1		Half Set Gasket (Bus)	Set.	
2066.104		Half Set Gasket (Rubber / Stamp) Truck	Set.	
2066.104.1		Half Set Gasket (Klingrite) (Rubber/Stamp) Bus	Set.	
2066.050	51 03901 0403	Cylinder Cover Gasket (Native Ø121)	Pcs.	
2076.050	51 03901 0387	Cylinder Cover Gasket (Native Ø127)	Pcs.	
2066.060	51 05904 0210	Oil Pan Gasket (Klingrite)	Pcs.	
2066.061	51 05904 0212	Oil Pan Gasket (TGA Rubber)	Pcs.	
2066.070	51 05901 0144	Oil Radiator Gasket (Klingrite)	Pcs.	
2066.070.1	51 05901 0160	Oil Radiator Gasket (Nbr Metal)	Pcs.	
2066.080	51 03905 0177	Valve Cover Gasket (Rubber)	Pcs.	
2066.010	51 01905 0091	Eccentric Cover Gasket (Klingrite)	Pcs.	
2066.010.1	51 01905 0092	Eccentric Cover Gasket (Nbr Metal)	Pcs.	
2066.131	06 56631 0111	Water Pump Gasket (Klingrite)	Pcs.	
2066.131.1	06 56631 0192	Water Pump Gasket (Nbr Metal)	Pcs.	
2066.152	51 08901 0195	Agr Gasket	Pcs.	
2066.155	51 08901 0172	Agr Gasket	Pcs.	
2066.160	51 08901 0170	Exhaust Manifold Gasket	Pcs.	
2066.161		Exhaust Manifold Gasket	Pcs.	
2066.203	51 06903 0061	Water Pump Gasket (Block Side Klingrite)	Pcs.	
2066.203.1	51 06903 0061	Water Pump Gasket (Block Side Nbr Metal)	Pcs.	
2066.261	51 06904 0039	Thermostat Gasket (Top Klingrit)	Pcs.	
2066.261.1	51 06904 0039	Thermostat Gasket (Nbr Metal)	Pcs.	
2066.262	51 06904 0042	Thermostat Gasket (Lower Klingrite)	Pcs.	
2066.262.1	51 06904 0042	Thermostat Gasket (Lower Nbr Metal)	Pcs.	
2066.306.1	51 08901 0124	Agr Small Gasket	Pcs.	
2066.401.2	51 08901 0120	Gasket (Wired Klingrite)	Pcs.	
2066.407		Gasket	Pcs.	
240.501		Turbine Square Gasket	Pcs.	
2066.502		Turbine Square Gasket	Pcs.	
401.505		Turbo Oil Pipe Gasket	Pcs.	



Dortrenk Turizm Gayr. Mot.Tas.San. ve Tic. Ltd.Şti.
Tax Administration & No:
 Ikitelli / 313 058 5172
Adress :
 Ikitelli O.S.B Dolapdere Sanayi Sitesi 12.Ada No:56
 Basaksehir / Istanbul / Turkiye
Tel :+90 (212) 243 02 03 Fax: +90 (212) 355 02 42
Email: bilgi@otobusyedekparca.com

01-2017

For MAN	D.2676.TGA/X STARLLINER LF.01/05/11/12/13 /14 / LOH 01/02 / 6.CYL 12.412 CCM Ø126						
							
2676.050 Ø127	2066.060 (BUS)		2066.061 Rubber (TRUCK)				
							
2676.070	2066.070	2066.080		2066.010			
							
2066.131	2066.203	2066.160	2066.161	2066.152			
							
2066.154	2066.155	2066.156	2066.261	2066.262			
							
240.501	2066.502	401.505	2066.306.1	2066.401.2	2066.407	402.260	



Dortrenk Turizm Gayr. Mot.Tas.San. ve Tic. Ltd.Şti.
Tax Administration & No:
 Ikitelli / 313 058 5172
Address :
 Ikitelli O.S.B Dolapdere Sanayi Sitesi 12.Ada No:56
 Basaksehir / Istanbul / Turkiye
Tel :+90 (212) 243 02 03 Fax: +90 (212) 355 02 42
Email:bilgi@otobusyedekparca.com

01-2017

For MAN		D.2676.TGA/X / STARLLINER LF.01/05/11/12/13 /14 / LOH 01/02 / 6.CYL 12.412 CCM Ø126		
IMSP Ref	ORJ. REF.	DESCRIPTION	Unit	
2676.100	51.00900.6680	Full Set Gasket Ø121 (TGA Truck)	Set.	
2676.100.1	51.00900.6680	Full Set Gasket Ø121 (Orj. TGA Truck)	Set.	
2066.101	51 00900 6681	Cylinder Head Gasket Ø121 (Native SKC)	Set.	
2676.101	51 00900 6681	Cylinder Head Gasket Ø127 (Native SKC)	Set.	
2066.102		Half Set Gasket (Truck)	Set.	
2066.102.1		Half Set Gasket (Otobüs)	Set.	
2066.104		Half Set Gasket (Rubber/Stamp) (Truck)	Set.	
2066.104.1		Half Set Gasket (Klingrite) (Rubber/Stamp) Bus	Set.	
26766.050	51 03901 0403	Cylinder Cover Gasket (Native Ø121)	Pcs.	
2676.050	51 03901 0387	Cylinder Cover Gasket (Native Ø127)	Pcs.	
2066.060	51 05904 0210	Oil Pan Gasket (Klingrite)	Pcs.	
2066.061	51 05904 0212	Oil Pan Gasket (TGA Rubber)	Pcs.	
2676.070	51 05901 0144	Oil Radiator Gasket (Klingrite)	Pcs.	
2676.070.1	51 05901 0160	Oil Radiator Gasket (Nbr Metal)	Pcs.	
2066.080	51 03905 0177	Valve Cover Gasket (Rubber)	Pcs.	
240.080	51 03905 0157	Valve Cover Gasket (No Reader)	Pcs.	
2066.010	51 01905 0091	Eccentric Cover Gasket (Klingrite)	Pcs.	
2066.010.1	51 01905 0092	Eccentric Cover Gasket (Nbr Metal)	Pcs.	
2066.131	06 56631 0111	Water Pump Gasket (Klingrite)	Pcs.	
2066.131.1	06 56631 0192	Water Pump Gasket (Nbr Metal)	Pcs.	
2066.152	51 08901 0195	Agr Gasket	Pcs.	
2066.154		Agr Gasket	Pcs.	
2066.155	51 08901 0172	Agr Gasket	Pcs.	
2066.156		Agr Gasket	Pcs.	
2066.160	51 08901 0170	Exhaust Manifold Gasket	Pcs.	
2066.161		Exhaust Manifold Gasket	Pcs.	
2066.203	51 06903 0061	Water Pump Gasket (Block Side Klingrite)	Pcs.	
2066.203.1	51 06903 0061	Water Pump Gasket (Block Side Nbr Metal)	Pcs.	
2066.261	51 06904 0039	Thermostat Gasket (Top Klingrite)	Pcs.	
2066.261.1	51 06904 0039	Thermostat Gasket (Nbr Metal)	Pcs.	
2066.262	51 06904 0042	Thermostat Gasket (Lower Klingrite)	Pcs.	
2066.262.1	51 06904 0042	Thermostat Gasket (Lower Nbr Metal)	Pcs.	
2066.306.1	51 08901 0124	Agr Small Gasket	Pcs.	
2066.401.2	51 08901 0120	Gasket (Wired Klingrite)	Pcs.	
2066.407		Gasket	Pcs.	
240.501		Turbine Square Gasket	Pcs.	
2066.502		Turbine Square Gasket	Pcs.	
401.505		Turbo Oil Pipe Gasket	Pcs.	



Dortrenk Turizm Gayr. Mot.Tas.San. ve Tic. Ltd.Şti.

Tax Administration & No:

Ikitelli / 313 058 5172

Adress :







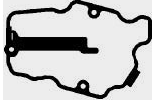
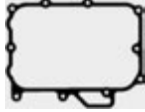

Ikitelli O.S.B Dolapdere Sanayi Sitesi 12.Ada No:56

Basaksehir / Istanbul / Turkiye

Tel :+90 (212) 243 02 03 Fax: +90 (212) 355 02 42

Email: bilgi@otobusyedeckparca.com

01-2017

For MAN	D2862 LE 421-422-432-432-463-631-632-633 D2868 LE 421-422-LF02-LF03-LF04-LF05-LF06-LF07			
				
2868.050	2868.080	2868.070	2868.060	
				
2868.010	2868.011	2868.301	2868.302	2868.150
				
2868.160	2868.170			



Dortrenk Turizm Gayr. Mot.Tas.San. ve Tic. Ltd.Şti.

Tax Administration & No:

Ikitelli / 313 058 5172

Adress :

Ikitelli O.S.B Dolapdere Sanayi Sitesi 12.Ada No:56

Basaksehir / Istanbul / Turkiye

Tel :+90 (212) 243 02 03 Fax: +90 (212) 355 02 42

Email: bilgi@otobusyedekparca.com

01-2017

For MAN		D2862 LE 421-422-432-432-463-631-632-633 D2868 LE 421-422-LF02-LF03-LF04-LF05-LF06-LF07		
IMSP Ref	ORJ. REF.	DESCRIPTION	Unit	
2868.050		Cylinder Cover Gasket	Pcs.	
2868.080		Rocker Arm Cover Gasket	Pcs.	
2868.070		Oil Cooler Gasket	Pcs.	
2868.060		Oil Pan Gasket	Pcs.	
2868.010		Gasket	Pcs.	
2868.011		Gasket	Pcs.	
2868.301		Gasket	Pcs.	
2868.302		Gasket	Pcs.	
2868.150		Intake Manifold Gasket	Pcs.	
2868.160		Exhaust Manifold Gasket	Pcs.	
2868.170		Exhaust Gasket	Pcs.	



Dortrenk Turizm Gayr. Mot.Tas.San. ve Tic. Ltd.Şti.
Tax Administration & No:
 Ikitelli / 313 058 5172
Address :
 Ikitelli O.S.B Dolapdere Sanayi Sitesi 12.Ada No:56
 Basaksehir / Istanbul / Turkiye
Tel :+90 (212) 243 02 03 Fax: +90 (212) 355 02 42
Email: bilgi@otobusyedekparca.com

01-2017

MAN	TGA 19.360.19.410 . 19.440 – 19.400					
240.050	240.101	240.010	240.060			
240.070 ACM	240.080	240.081	401.010	401.131	240.022	
240.0192	401.260	240.301	240.180	280.112	401.070	
240.305	240.303	240.304	240.306	240.307	240.400	
240.239	402.260	401.013	401.403	401.404	401.405	
401.406	401.407	401.408	401.409	401.413	401.454	
240.490	240.134	401.134	280.069	240.072	240.300	
240.150	240.160	240.501	401.502	401.504	401.505	2066.155



Dortrenk Turizm Gayr. Mot.Tas.San. ve Tic. Ltd.Şti.
Tax Administration & No:
 Ikitelli / 313 058 5172
Address :
 Ikitelli O.S.B Dolapdere Sanayi Sitesi 12.Ada No:56
 Basaksehir / Istanbul / Turkiye
Tel :+90 (212) 243 02 03 Fax: +90 (212) 355 02 42
Email: bilgi@otobusyedekparca.com

01-2017

For MAN		TGA 19.360-19.410 - 19.440 – 19.400	
IMSP Ref	ORJ. REF.	DESCRIPTION	Unit
240.100	061.691	Full Set Gasket (TGA-410)	Set.
240.101	51 009006558	Cylinder Head Gasket (No Reader Valva + Orj. Cyl.)	Set.
241.101	51.009006630	Cylinder Head Gasket (No Reader Valva + Orj. Cyl.)	Set.
240.102		Half Set Gasket (TGA)	Set.
240.104		Half Set Gasket (Rubber/Stamp TGA)	Set.
240.150		Full Set Gasket (Cylinder Cover Gasket Excluded) TGA 19460.410.390.460	Set.
240.050	51 03901 0338	Cylinder Head gasket	Pcs.
240.060		Oil Pan Gasket (TG-A 19.410-19.463)	Pcs.
280.069		Gasket	Pcs.
240.070	51 05901 0122	Gasket	Pcs.
421.070	442 188 05 80	Gasket	Pcs.
240.080	51 03905 0157	Valve Cover Gasket	Pcs.
240.081	51 03905 0161	Valve Cover Gasket	Pcs.
240.010		Front Cover Gasket	Pcs.
240.010-1	51 01901 0129	Front Cover Gasket (Nbr Metal)	Pcs.
280.112	51 01903 0252	Flywheel Rear Gasket	Pcs.
240.134	51 06901 0111	Gasket	Pcs.
240.150	51 08902 0194	Intake Manifold Gasket	Pcs.
240.160	51.08901 0155	Exhaust Manifold Gasket	Pcs.
240.180		Gasket	Pcs.
240.239		Gasket	Pcs.
240.301	51 08901 0114	AGR Gasket (İnterkol)	Pcs.
240.301-1	51 08901 0114	AGR Gasket (İnterkol)	Pcs.
240.303	51 06901 0157	Gasket	Pcs.
240.304		Agr Cover Gasket	Pcs.
240.305		Agr Gasket	Pcs.
240.306	51 08901 0124	Agr Gasket	Pcs.
240.307	51 06901 0157	Gasket	Pcs.
240.400		Gasket	Pcs.
240.490		İnterkol Gasket	Pcs.
240.490-2		İnterkol Gasket (Wired Klingrite)	Pcs.
240.0192	81.6644.0192	Mud Rubber	Pcs.
240.022		Compressor Gasket	Pcs.
401.013	407 015 03 80	Gasket	Pcs.
401.134	442 201 04 80	Gasket	Pcs.
401.134-2	442 201 04 80	Gasket (Wired)	Pcs.
401.260		Thermostat Gasket	Pcs.
401.403	447 014 01 80	Oil Pan Gasket	Pcs.
401.405	917003036003	V/8 403 Retarder Gasket	Pcs.
401.406	917003266003	Gasket	Pcs.
401.407		Gasket	Pcs.
401.408		Gasket	Pcs.
401.409		Gasket	Pcs.
240.501		Turbo Gasket	Pcs.
401.502	427 144 01 80	Turbo Gasket (3031-403-442)	Pcs.
401.504	442 187 01 80	Turbo Gasket	Pcs.
401.505	442 187 00 80	Turbo Gasket	Pcs.
441.506	422 997 00 40	Turbo O-ring	Pcs.
2066.155		Gasket	Pcs.



Dortrenk Turizm Gayr. Mot.Tas.San. ve Tic. Ltd.Şti.
Tax Administration & No:
 Ikitelli / 313 058 5172
Adress :
 Ikitelli O.S.B Dolapdere Sanayi Sitesi 12.Ada No:56
 Basaksehir / Istanbul / Turkiye
Tel :+90 (212) 243 02 03 Fax: +90 (212) 355 02 42
Email: bilgi@otobusyedekparca.com

01-2017

For MAN		FORTUNA D.2876 LF 01.02					
240.050	240.101	421.070			280.060		
240.070 ACM	240.080	240.081	401.010	457.131	240.022		
240.0192	401.260	240.301	240.180	280.112	240.010		
240.305	240.303	240.304	240.306	240.307	240.400		
240.239	402.260	401.013	401.403	401.404	401.405		
401.406	401.407	401.408	401.409	401.413	401.454		
240.490	240.134	401.134	280.069	240.072	240.300		
240.150	240.160	241.501	401.502		401.504	401.505	
						2066.155	



Dortrenk Turizm Gayr. Mot.Tas.San. ve Tic. Ltd.Şti.
Tax Administration & No:
 Ikitelli / 313 058 5172
Address :
 Ikitelli O.S.B Dolapdere Sanayi Sitesi 12.Ada No:56
 Basaksehir / Istanbul / Turkiye
Tel :+90 (212) 243 02 03 Fax: +90 (212) 355 02 42
Email:bilgi@otobusyedekparca.com

01-2017

For MAN		FORTUNA D-2876 LF 01-02	
IMSP Ref	ORJ. REF.	DESCRIPTION	Unit
241.100		Full Set Gasket (Fortuna)	Set.
240.101	51 009006558	Cylinder Head Gasket Set (No Reader Valve+Orj. Cyl.)	Set.
241.101	51.009006630	Cylinder Head Gasket (No Reader Valve+Orj. Cyl.)	Set.
241.102		Half Set Gasket (Fortuna)	Set.
241.104		Half Set Gasket (Rubber/Stamp) – (Fortuna)	Set.
241.105		Full Set Gasket (Cylinder Cover Excluded) – (Fortuna)	Set.
240.050	51 03901 0338	Cylinder Head gasket	Pcs.
280.060	51 05904 0132	Oil Pan Gasket	Pcs.
240.070	51 05901 0122	Gasket (Rubber)	Pcs.
421.070	442 188 05 80	Gasket	Pcs.
240.080	51 03905 0157	Valve Cover Gasket	Pcs.
240.081	51 03905 0161	Valve Cover Gasket	Pcs.
240.010-1	51 01901 0129	Gasket (Nbr Metal)	Pcs.
280.112	51 01903 0252	Flywheel Rear Gasket	Pcs.
240.134	51 06901 0111	Gasket	Pcs.
240.150	51 08902 0194	Intake Manifold Gasket	Pcs.
240.160	51.08901 0155	Exhaust manifold Gasket	Pcs.
280.069		Gasket	Pcs.
240.150	51 08902 0194	Intake Manifold Gasket	Pcs.
240.160	51.08901 0155	Exhaust Manifold Gasket	Pcs.
240.180		Gasket	Pcs.
240.239		Gasket	Pcs.
240.301	51 08901 0114	AGR Gasket (Interkol)	Pcs.
240.301-1	51 08901 0114	AGR Gasket (Interkol)	Pcs.
240.303	51 06901 0157	Gasket	Pcs.
240.304		Agr Gasket	Pcs.
240.305		Agr Gasket	Pcs.
240.306	51 08901 0124	Agr Gasket	Pcs.
240.307	51 06901 0157	Gasket	Pcs.
240.400		Gasket	Pcs.
240.490		İnterkol Gasket	Pcs.
240.490-1		İnterkol Gasket	Pcs.
240.0192	81.6644.0192	Mud Rubber	Pcs.
240.022		Compressor Connection Gasket	Pcs.
401.010	442 011 00 80	Eccentric Cover Gasket	Pcs.
401.010-2	442 011 00 80	Eccentric Cover Gasket (Wired)	Pcs.
401.013	407 015 03 80	Gasket	Pcs.
401.131	442 201 10 80	Water Pump Gasket	Pcs.
401.134	442 201 04 80	Gasket	Pcs.
401.134-2	442 201 04 80	Gasket (Wired)	Pcs.
401.260		Thermostat Gasket	Pcs.
402.260		Thermostat Gasket	Pcs.
401.403	447 014 01 80	Oil Pan Gasket	Pcs.
401.405	917003036003	V/8 403 Retarder Gasket	Pcs.
401.406	917003266003	Gasket	Pcs.
401.407		Gasket	Pcs.
401.408		Gasket	Pcs.
401.409		Gasket	Pcs.
241.501		Turbo Gasket	Pcs.
401.502	427 144 01 80	Turbo Gasket (3031-403-442)	Pcs.
401.504	442 187 01 80	Turbo Gasket	Pcs.
401.505	442 187 00 80	Turbo Gasket	Pcs.



Dortrenk Turizm Gayr. Mot.Tas.San. ve Tic. Ltd.Şti.
Tax Administration & No:
 İkitelli / 313 058 5172
Address :
 İkitelli O.S.B Dolapdere Sanayi Sitesi 12.Ada No:56
 Basaksehir / İstanbul / Türkiye
Tel :+90 (212) 243 02 03 Fax: +90 (212) 355 02 42
Email: bilgi@otobusyedekparca.com

01-2017

2066.155	Gasket				Pcs.	
For MAN	STARLINER / OTOBÜS MAN.TGA 19.480 / D.28.76					
480.050	240.101	240.060	240.070	480.080		
240.010	240.0192	240.480	240.022	280.112		
480.155	240.301	401.260	401.134	240.134	402.260	
480.150	480.160	240.501	401.502	401.504	401.505	
401.013	240.239	240.013	240.490	240.307	240.303	240.304



Dortrenk Turizm Gayr. Mot.Tas.San. ve Tic. Ltd.Şti.
Tax Administration & No:
 Ikitelli / 313 058 5172
Address :
 Ikitelli O.S.B Dolapdere Sanayi Sitesi 12.Ada No:56
 Basaksehir / Istanbul / Turkiye
Tel :+90 (212) 243 02 03 Fax: +90 (212) 355 02 42
Email:bilgi@otobusyedekparca.com













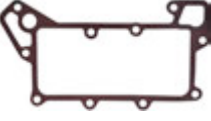























01-2017

For MAN		STARLINER - BUS MAN-TGA 19.480 / D-28.76		
IMSP Ref	ORJ. REF.	DESCRIPTION	Unit	
480.100		Full Set Gasket (Orj.)	Set.	
480.102		Half Set Gasket	Set.	
480.104		Half Set Gasket (Rubber/Stamp)	Set.	
480.105		Full Set Gasket (Cylinder Cover Excluded)	Set.	
480.050		Cylinder Gasket	Pcs.	
240.060		Oil Pan Gasket (Rubber / TG-A 19.410-19.463)	Pcs.	
240.070	51 05901 0122	Gasket	Pcs.	
421.070	442 188 05 80	Gasket	Pcs.	
480.080	51 03905 0188	Valve Cover Gasket	Pcs.	
240.010-1	51 01901 0129	Gasket (Nbr Metal)	Pcs.	
280.112	51 01903 0252	Flywheel Rear Gasket	Pcs.	
240.134	51 06901 0111	Gasket	Pcs.	
280.069		Gasket	Pcs.	
240.400		Gasket	Pcs.	
240.134	51 06901 0111	Gasket	Pcs.	
480.150	51 08902 0202	Intake Manifold Gasket (Aluminum)	Pcs.	
480.155		Agr Gasket	Pcs.	
480.160	51.08901 0155	Exhaust Manifold Gasket	Pcs.	
240.180		Gasket	Pcs.	
240.239		Gasket	Pcs.	
240.301	51 08901 0114	AGR Gasket (İnterkol)	Pcs.	
240.301-1	51 08901 0114	AGR Gasket (İnterkol)	Pcs.	
240.303	51 06901 0157	Gasket	Pcs.	
240.304		Agr Gasket	Pcs.	
240.305		Agr Gasket	Pcs.	
240.306	51 08901 0124	Agr Gasket	Pcs.	
240.307	51 06901 0157	Gasket	Pcs.	
240.490		İnterkol Gasket	Pcs.	
240.490-1		İnterkol Gasket	Pcs.	
240.0192	81.6644.0192	Mud Rubber	Pcs.	
240.022		Compressor Gasket	Pcs.	
401.013	407 015 03 80	Flywheel Gasket	Pcs.	
401.134	442 201 04 80	Gasket	Pcs.	
401.134-2	442 201 04 80	Gasket (Wired)	Pcs.	
401.260		Thermostat Gasket	Pcs.	
402.260		Thermostat Gasket	Pcs.	
240.501		Turbo Gasket	Pcs.	
401.502	427 144 01 80	Turbo Gasket (3031-403-442)	Pcs.	
401.504	442 187 01 80	Turbo Gasket	Pcs.	
401.505	442 187 00 80	Turbo Gasket	Pcs.	
480.301	51 08901 0114	Agr Gasket (İnterkol)	Pcs.	
480.303	51 06901 0157	Gasket	Pcs.	
480.304		Gasket	Pcs.	
480.306		Gasket	Pcs.	



Dortrenk Turizm Gayr. Mot.Tas.San. ve Tic. Ltd.Şti.
Tax Administration & No:
 Ikitelli / 313 058 5172
Adress :
 Ikitelli O.S.B Dolapdere Sanayi Sitesi 12.Ada No:56
 Basaksehir / Istanbul / Turkiye
Tel :+90 (212) 243 02 03 Fax: +90 (212) 355 02 42
Email: bilgi@otobusyedekparca.com

01-2017

For MAN			D.(2566 / 2866)		
					
280.050	280.050.1	281.050	281.050.1	280.060	
					
280.070	421.070		401.010	280.112	
					
280.080	280.012	280.131	401.131	280.180	280.603
					
240.022	421.150	401.160	302.170	401.501	401.502
					
401.013	280.065	280.069	401.134	401.504	401.505
					
401.260	280.490	240.490	240.303	401.403	401.404
					
401.405	401.406	401.407	401.408	401.409	401.412
					
401.413	401.454	280.068	401.500		



Dortrenk Turizm Gayr. Mot.Tas.San. ve Tic. Ltd.Şti.
Tax Administration & No:
 Ikitelli / 313 058 5172
Address :
 Ikitelli O.S.B Dolapdere Sanayi Sitesi 12.Ada No:56
 Basaksehir / Istanbul / Turkiye
Tel :+90 (212) 243 02 03 Fax: +90 (212) 355 02 42
Email: bilgi@otobusyedekparca.com

01-2017

For MAN		D-(26,281 2566 / 2866		
IMSP Ref	ORJ. REF.	DESCRIPTION	Unti	
280.100		Full Set Gasket (125Ø / 26280)	Set.	
281.100		Full Set Gasket (128Ø / 26281)	Set.	
280.101		Cylinder Head Gasket (125Ø)	Set.	
280.101-1		Cylinder Head Gasket (128Ø)	Set.	
281.101		Cylinder Head Gasket (125Ø Rubber)	Set.	
281.101-1		Cylinder Head Gasket (128Ø Rubber)	Set.	
280.102		Half Set Gasket	Set.	
280.104		Half Set Gasket (Rubber/Stamp)	Set.	
280.050	51 03901 0298	Cylinder Gasket (125.Ø)	Pcs.	
280.050-1	51 03901 0298	Cylinder Gasket (128.Ø)	Pcs.	
281.050	51 03901 0356	Cylinder Gasket (125.Ø Rubber)	Pcs.	
281.050-1	51 03901 0356	Cylinder Gasket (128.Ø Rubber)	Pcs.	
280.060	51 0590 40132	Oil Pan Gasket	Pcs.	
280.061		Oil Pan Gasket (4 Pcs)	Pcs.	
280.065		Gasket	Pcs.	
280.068		Gasket	Pcs.	
280.069	51 96601 0168	Gasket	Pcs.	
280.070	51 05901 0119	Gasket	Pcs.	
280.081	51 03905 0134	Valve Cover Gasket	Pcs.	
280.012		Gasket	Pcs.	
280.112	51 01903 0252	Flywheel Rear Gasket	Pcs.	
280.131	51 06901 0147	Water Pump Gasket	Pcs.	
280.180	650 336 0180	Gasket	Pcs.	
240.490		İnterkol Gasket	Pcs.	
240.490-1		İnterkol Gasket	Pcs.	
280.490		İnterkol Gasket	Pcs.	
280.603		Gasket	Pcs.	
421.070	442 188 05 80	Gasket	Pcs.	
441.070		Gasket	Pcs.	
401.068		Oil Pan Gasket	Pcs.	
401.010	442 011 00 80	Gasket	Pcs.	
401.010-2	442 011 00 80	Gasket	Pcs.	
401.013	407 015 03 80	Gasket	Pcs.	
401.131	442 201 10 80	Water Pump Gasket	Pcs.	
401.134	442 201 04 80	Gasket	Pcs.	
401.134-2	442 201 04 80	Gasket (Wired)	Pcs.	
401.150	442 141 17 80	Intake Manifold Gasket	Pcs.	
421.150	442 141 09 80	Intake Manifold Gasket (Aluminum)	Pcs.	
401.160	403 142 03 80	Exhaust Manifold Gasket	Pcs.	
302.170	355 141 03 80	Exhaust Pipe Gasket (78Ø)	Pcs.	
401.170	442 492 00 80	Exhaust Pipe Gasket (88Ø)	Pcs.	
401.260		Thermostat Gasket	Pcs.	
401.500		Turbo Gasket Set	Set.	
401.501	421 142 01 80	Turbo Kare Gasket	Pcs.	
401.502	427 144 01 80	Turbo Gasket (3031-403-442)	Pcs.	
401.504	442 187 01 80	Turbo Gasket	Pcs.	
401.505	442 187 00 80	Turbo Gasket	Pcs.	
441.506	422 997 00 40	Turbo O-ring	Pcs.	



Dortrenk Turizm Gayr. Mot.Tas.San. ve Tic. Ltd.Şti.
Tax Administration & No:
 Ikitelli / 313 058 5172
Adress :
 Ikitelli O.S.B Dolapdere Sanayi Sitesi 12.Ada No:56
 Basaksehir / Istanbul / Turkiye
Tel :+90 (212) 243 02 03 Fax: +90 (212) 355 02 42
Email: bilgi@otobusyedekparca.com

01-2017

For MAN			D.(19.422 / 2566 / 2866)			
280.050	280.050.1	281.050	281.050.1	280.060		
401.070	401.010	401.131	280.180	280.112		
280.080	280.012	240.022	280.065	280.068	280.069	401.260
421.150	401.160	302.170	401.501	401.502	401.504	
401.013	401.134	401.413	240.490	240.303	401.505	
401.405	401.406	401.407	401.408	401.409	401.454	



Dortrenk Turizm Gayr. Mot.Tas.San. ve Tic. Ltd.Şti.
Tax Administration & No:
 Ikitelli / 313 058 5172
Address :
 Ikitelli O.S.B Dolapdere Sanayi Sitesi 12.Ada No:56
 Basaksehir / Istanbul / Turkiye
Tel :+90 (212) 243 02 03 Fax: +90 (212) 355 02 42
Email: bilgi@otobusyedekparca.com

01-2017

For MAN		D-(26,281 19.422 / 2566 / 2866)		
IMSP Ref	ORJ. REF.	DESCRIPTION	Unit	
19422.100		Full Set Gasket (128Ø /Man-Attractive 19.422)	Set.	
281.101-1		Cylinder Head Gasket (128Ø Rubber)	Set.	
19422.102		Half Set Gasket (19.422)	Set.	
19422.104		Half Set Gasket (Rubber/Stamp) (19.422)	Set.	
281.050-1	51 03901 0356	Cylinder Gasket (128.Ø Rubber Cyl.)	Pcs.	
280.060	51 0590 40132	Oil Pan Gasket	Pcs.	
280.061		Oil Pan Gasket (4 Pcs)	Pcs.	
280.065		Gasket	Pcs.	
280.068		Gasket	Pcs.	
280.069	51 96601 0168	Gasket	Pcs.	
280.070	51 05901 0119	Gasket	Pcs.	
280.081	51 03905 0134	Valve Cover Gasket	Pcs.	
280.012		Gasket	Pcs.	
280.112	51 01903 0252	Flywheel Rear Gasket	Pcs.	
280.131	51 06901 0147	Water Pump Gasket	Pcs.	
280.180	650 336 0180	Gasket	Pcs.	
240.490		İnterkol Gasket	Pcs.	
240.490-1		İnterkol Gasket	Pcs.	
280.490		İnterkol Gasket	Pcs.	
280.603		Gasket	Pcs.	
421.070	442 188 05 80	Gasket	Pcs.	
441.070		Gasket	Pcs.	
401.068		Oil Pan Gasket	Pcs.	
401.010	442 011 00 80	Gasket	Pcs.	
401.010-2	442 011 00 80	Gasket	Pcs.	
401.013	407 015 03 80	Gasket	Pcs.	
401.131	442 201 10 80	Water Pump Gasket	Pcs.	
401.134	442 201 04 80	Gasket	Pcs.	
401.134-2	442 201 04 80	Gasket (Wired)	Pcs.	
401.150	442 141 17 80	Intake Manifold Gasket	Pcs.	
421.150	442 141 09 80	Intake Manifold Gasket (Aluminum)	Pcs.	
401.160	403 142 03 80	Exhaust Manifold Gasket	Pcs.	
302.170	355 141 03 80	Exhaust Pipe Gasket (78Ø)	Pcs.	
401.170	442 492 00 80	Exhaust Pipe Gasket (88Ø)	Pcs.	
401.260		Thermostat Gasket	Pcs.	
401.500		Turbo Gasket set	Set.	
401.501	421 142 01 80	Turbo Gasket	Pcs.	
401.502	427 144 01 80	Turbo Gasket (3031-403-442)	Pcs.	
401.504	442 187 01 80	Turbo Gasket	Pcs.	
401.505	442 187 00 80	Turbo Gasket	Pcs.	
441.506	422 997 00 40	Turbo O-ring	Pcs.	



Dortrenk Turizm Gayr. Mot.Tas.San. ve Tic. Ltd.Şti.
Tax Administration & No:
 Ikitelli / 313 058 5172
Adress :
 Ikitelli O.S.B Dolapdere Sanayi Sitesi 12.Ada No:56
 Basaksehir / Istanbul / Turkiye
Tel :+90 (212) 243 02 03 Fax: +90 (212) 355 02 42
Email: bilgi@otobusyedekparca.com

01-2017

For MAN		D.19.463 / 2566 / 2866)			
442.050 Ø128	281.101	280.112	240.060		
240.070	401.070	401.010	280.012	401.131	
280.080	280.180	280.603	240.022	280.065	280.069
421.150	401.160	302.170	240.501	401.502	401.504
401.013	401.409	401.134	240.490	240.303	401.505
401.260	401.413	401.405	401.454	401.412	401.404
401.406	401.407	401.408	280.068	401.500	



Dortrenk Turizm Gayr. Mot.Tas.San. ve Tic. Ltd.Şti.
Tax Administration & No:
 Ikitelli / 313 058 5172
Address :
 Ikitelli O.S.B Dolapdere Sanayi Sitesi 12.Ada No:56
 Basaksehir / Istanbul / Turkiye
Tel :+90 (212) 243 02 03 Fax: +90 (212) 355 02 42
Email: bilgi@otobusyedekparca.com

01-2017

For MAN		D-(26,281 / 19.463 / 2566 / 2866)		
IMSP Ref	ORJ. REF.	DESCRIPTION	Unit	
463.100		Full Set Gasket (128Ø / 19.423-463)	Set.	
463.100-1		Full Set Gasket (128Ø / 19.423-463)	Set.	
281.101-1		Cylinder Head Gasket (128Ø Rubber)	Set.	
463.102		Half Set Gasket (19.423-463)	Set.	
463.104		Half Set Gasket (Rubber/Stamp) (19.423-463)	Set.	
281.050-1	51 03901 0356	Cylinder Gasket (128Ø Rubber)	Pcs.	
240.060		Oil Pan Gasket (TG-A 19.410-19.463)	Pcs.	
280.065		Gasket	Pcs.	
280.068		Gasket	Pcs.	
280.069	51 96601 0168	Gasket	Pcs.	
240.070	51 05901 0122	Gasket	Pcs.	
421.070	442 188 05 80	Gasket	Pcs.	
280.081	51 03905 0134	Valve Cover Gasket	Pcs.	
280.012		Gasket	Pcs.	
280.112	51 01903 0252	Flywheel Rear Gasket	Pcs.	
280.131	51 06901 0147	Water Pump Gasket	Pcs.	
280.180	650 336 0180	Gasket	Pcs.	
240.490		İnterkol Gasket	Pcs.	
240.490-1		İnterkol Gasket	Pcs.	
280.490		İnterkol Gasket	Pcs.	
280.603		Gasket	Pcs.	
401.068		Oil Pan Gasket	Pcs.	
401.010	442 011 00 80	Gasket	Pcs.	
401.010-2	442 011 00 80	Gasket	Pcs.	
401.013	407 015 03 80	Gasket	Pcs.	
401.131	442 201 10 80	Water Pump Gasket	Pcs.	
401.134	442 201 04 80	Gasket	Pcs.	
401.134-2	442 201 04 80	Gasket (Wired)	Pcs.	
401.150	442 141 17 80	Intake Manifold Gasket	Pcs.	
421.150	442 141 09 80	Intake Manifold Gasket (Aluminum)	Pcs.	
401.160	403 142 03 80	Exhaust Manifold Gasket	Pcs.	
302.170	355 141 03 80	Exhaust Pipe Gasket (78Ø)	Pcs.	
401.170	442 492 00 80	Exhaust Pipe Gasket (88Ø)	Pcs.	
401.260		Thermostat Gasket	Pcs.	
401.500		Turbo Gasket Set	Set.	
401.501	421 142 01 80	Turbo Gasket	Pcs.	
401.502	427 144 01 80	Turbo Gasket (3031-403-442)	Pcs.	
401.504	442 187 01 80	Turbo Gasket	Pcs.	
401.505	442 187 00 80	Turbo Gasket	Pcs.	
441.506	422 997 00 40	Turbo O-ring	Pcs.	



Dortrenk Turizm Gayr. Mot.Tas.San. ve Tic. Ltd.Şti.

Tax Administration & No:

Ikitelli / 313 058 5172

Adress :

Ikitelli O.S.B Dolapdere Sanayi Sitesi 12.Ada No:56

Basaksehir / Istanbul / Turkiye

Tel :+90 (212) 243 02 03 Fax: +90 (212) 355 02 42

Email: bilgi@otobusyedekparca.com

01-2017



Dortrenk Turizm Gayr. Mot.Tas.San. ve Tic. Ltd.Şti.

Tax Administration & No:

Ikitelli / 313 058 5172

Adress :

Ikitelli O.S.B Dolapdere Sanayi Sitesi 12.Ada No:56

Basaksehir / Istanbul / Turkiye

Tel :+90 (212) 243 02 03 Fax: +90 (212) 355 02 42

Email: bilgi@otobusyedekparca.com

01-2017

MARATON SAFIR

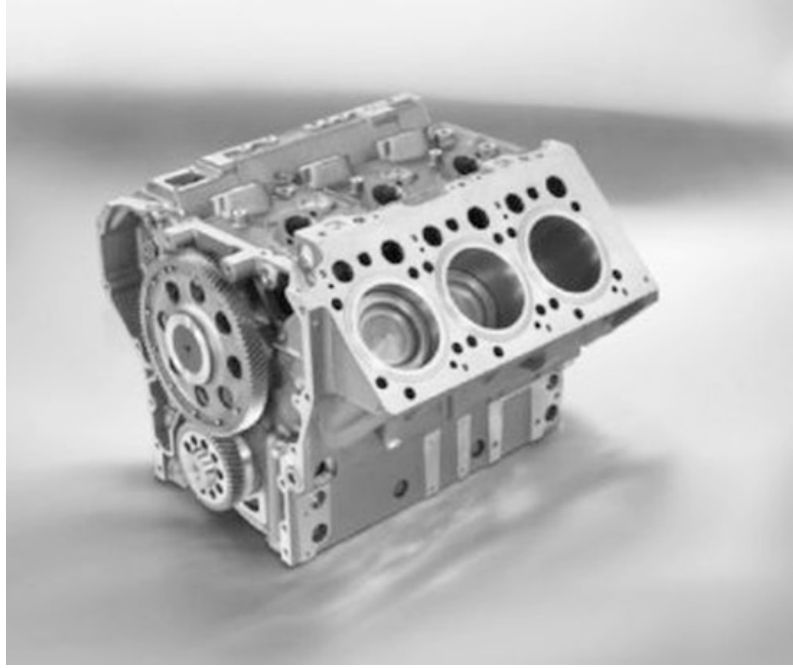

SECTION



Dortrenk Turizm Gayr. Mot.Tas.San. ve Tic. Ltd.Şti.

Tax Administration & No:

Ikitelli / 313 058 5172

Adress :

Ikitelli O.S.B Dolapdere Sanayi Sitesi 12.Ada No:56

Basaksehir / Istanbul / Turkiye

Tel :+90 (212) 243 02 03 Fax: +90 (212) 355 02 42

Email: bilgi@otobusyedekparca.com

01-2017

MARATON		MS 713 E/M – MS 715 Y/M PRENSES .BUS					
300.050		300.060		300.070			
300.080		300.090		300.010			
300.078	300.079	300.112	300.113	301.112	301.113		
300.131	301.131	300.132	301.132	300.150	300.160		
300.170	300.180	300.181	300.201	300.202	300.203		
300.260	300.270	300.271	300.171	300.280	300.291	300.290	



Dortrenk Turizm Gayr. Mot.Tas.San. ve Tic. Ltd.Şti.
Tax Administration & No:
 Ikitelli / 313 058 5172
Address :
 Ikitelli O.S.B Dolapdere Sanayi Sitesi 12.Ada No:56
 Basaksehir / Istanbul / Turkiye
Tel :+90 (212) 243 02 03 Fax: +90 (212) 355 02 42
Email: bilgi@otobusyedeckparca.com

















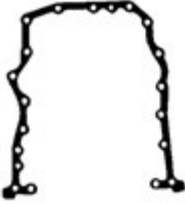







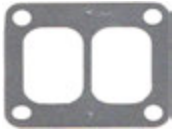



01-2017

For MARATON		MS 713 E/M – MS 715 Y/M PRENSES .BUS		
IMSP Ref	ORJ. REF.	DESCRIPTION	Unit	
300.102		Half Set Gasket (Old Model)	Set.	
300.104		Half Set Gasket (Rubber/Stamp Set/ Old Model)	Set.	
301.102		Half Set Gasket (New Model)	Set.	
301.104		Half Set Gasket (Rubber/Stamp Set / New Model)	Set.	
300.050		Cylinder Cover Gasket	Pcs.	
300.060		Oil Pan Gasket	Pcs.	
300.070		Oil Radiator Gasket	Pcs.	
300.080		Valve Cover Gasket	Pcs.	
300.090		Side Cover Gasket (Nbr)	Pcs.	
300.010		Eccentric Cover Gasket	Pcs.	
300.112		Flywheel Rear Gasket (Old Model)	Pcs.	
300.113		Flywheel Rear Gasket (Old Model)	Pcs.	
300.130		Water Pump Set Gasket	Pcs.	
300.131		Water Pump Gasket (Old Model)	Pcs.	
300.132		Water Pump Gasket (Old Model)	Pcs.	
300.150		Intake Manifold Gasket	Pcs.	
300.160		Exhaust Manifold Gasket	Pcs.	
300.170		Exhaust Butterfly Gasket	Pcs.	
300.171		Exhaust Throat Gasket	Pcs.	
300.180		Aks Back Gasket	Pcs.	
300.181		Aks Front Gasket	Pcs.	
300.260		Thermostat Gasket	Pcs.	
300.270		Exhaust Suction Sieve Gasket (Old Model)	Pcs.	
300.271		Exhaust Suction Gasket	Pcs.	
300.280		Water Pipe Gasket	Pcs.	
300.078		Gasket	Pcs.	
300.079		Gasket	Pcs.	
300.201		Water Pipe Gasket	Pcs.	
300.202		Gasket	Pcs.	
300.203		Water Way Gasket	Pcs.	
300.290		Gasket	Pcs.	
300.291		Gasket	Pcs.	
For MARATON MS . 715				
301.112		Flywheel Rear Gasket (New Model)	Pcs.	
301.113		Flywheel Rear Gasket (New Model)	Pcs.	
301.130		Water Pump Set Gasket (New Model)	Pcs.	
301.131		Water Pump Gasket (New Model)	Pcs.	
301.132		Water Pump Gasket (New Model)	Pcs.	



Dortrenk Turizm Gayr. Mot.Tas.San. ve Tic. Ltd.Şti.
Tax Administration & No:
Ikitelli / 313 058 5172
Adress :
Ikitelli O.S.B Dolapdere Sanayi Sitesi 12.Ada No:56
Basaksehir / Istanbul / Turkiye
Tel :+90 (212) 243 02 03 Fax: +90 (212) 355 02 42
Email: bilgi@otobusyedekparca.com

01-2017

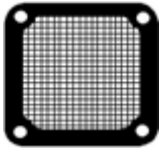
SAFİR / MITSUBISHI / MS 827				
				
299.050	299.060	299.070	299.090	
				
299.010	299.080	299.112	299.113	299.280
				
299.260	299.270	299.020	299.021	
				
299.150	299.160	299.170	299.501	
				
299.201	299.202	299.203	299.204	299.205
				
299.206	299.402	299.403	299.404	299.401
				
299.271	299.606	299.607	300.270	



Dortrenk Turizm Gayr. Mot.Tas.San. ve Tic. Ltd.Şti.
Tax Administration & No:
Ikitelli / 313 058 5172
Address :
Ikitelli O.S.B Dolapdere Sanayi Sitesi 12.Ada No:56
Basaksehir / Istanbul / Turkiye
Tel :+90 (212) 243 02 03 Fax: +90 (212) 355 02 42
Email: bilgi@otobusyedekparca.com

01-2017

SAFiR / MITSUBISHI / MS 827				
IMSP Ref.	ORJ. Ref.	DESCRIPTION	Unit	
299.100.1		Full Set Gasket	Set.	
299.102		Half Set Gasket	Set.	
299.104		Half Set Gasket (Rubber Set/Stamp Set)	Set.	
299.050	ME051714	Cylinder Cover Gasket (6D22)	Pcs.	
299.050	ME051714	Cylinder Cover Gasket (6D22) (1.Quality)	Pcs.	
299.060		Oil Pan Gasket	Pcs.	
299.070		Oil Radiator Gasket (Wired Klingrit)	Pcs.	
299.080		Valve Cover Gasket	Pcs.	
299.090		Side Cover Gasket (Valve Cup Cover)	Pcs.	
299.010		Eccentric Cover Gasket	Pcs.	
299.020		Compressor Gasket	Pcs.	
299.021		Compressor Gasket	Pcs.	
299.112		Flywheel Rear Gasket	Pcs.	
299.113		Flywheel Rear Gasket	Pcs.	
299.150		Intake Manifold Gasket	Pcs.	
299.160		Exhaust Manifold Gasket	Pcs.	
299.170		Exhaust Butterfly Gasket	Pcs.	
299.260		Thermostat Gasket	Pcs.	
299.270		Intercol Gasket	Pcs.	
299.280		Water Pipe Gasket	Pcs.	
299.201		Gasket	Pcs.	
299.202		Gasket	Pcs.	
299.203		Water Gasket	Pcs.	
299.204		Gasket	Pcs.	
299.205		Gasket	Pcs.	
299.206		Gasket	Pcs.	
299.401		Gasket	Pcs.	
299.402		Oil Pipe Gasket	Pcs.	
299.403		Gasket	Pcs.	
299.404		Gasket	Pcs.	
299.501		Turbine Gasket	Pcs.	
299.607		Shirt Rubber Gasket	Pcs.	



Dortrenk Turizm Gayr. Mot.Tas.San. ve Tic. Ltd.Şti.

Tax Administration & No:

Ikitelli / 313 058 5172

Adress :

Ikitelli O.S.B Dolapdere Sanayi Sitesi 12.Ada No:56
Basaksehir / Istanbul / Turkiye

Tel :+90 (212) 243 02 03 Fax: +90 (212) 355 02 42

Email: bilgi@otobusyedekparca.com

01-2017



Dortrenk Turizm Gayr. Mot.Tas.San. ve Tic. Ltd.Şti.

Tax Administration & No:

Ikitelli / 313 058 5172

Adress :

Ikitelli O.S.B Dolapdere Sanayi Sitesi 12.Ada No:56

Basaksehir / Istanbul / Turkiye

Tel :+90 (212) 243 02 03 Fax: +90 (212) 355 02 42

Email: bilgi@otobusyedekparca.com

01-2017

DEUTZ COBRA



Dortrenk Turizm Gayr. Mot.Tas.San. ve Tic. Ltd.Şti.

Tax Administration & No:

Ikitelli / 313 058 5172

Adress :

Ikitelli O.S.B Dolapdere Sanayi Sitesi 12.Ada No:56

Basaksehir / Istanbul / Turkiye

Tel :+90 (212) 243 02 03 Fax: +90 (212) 355 02 42

Email: bilgi@otobusyedekparca.com

01-2017

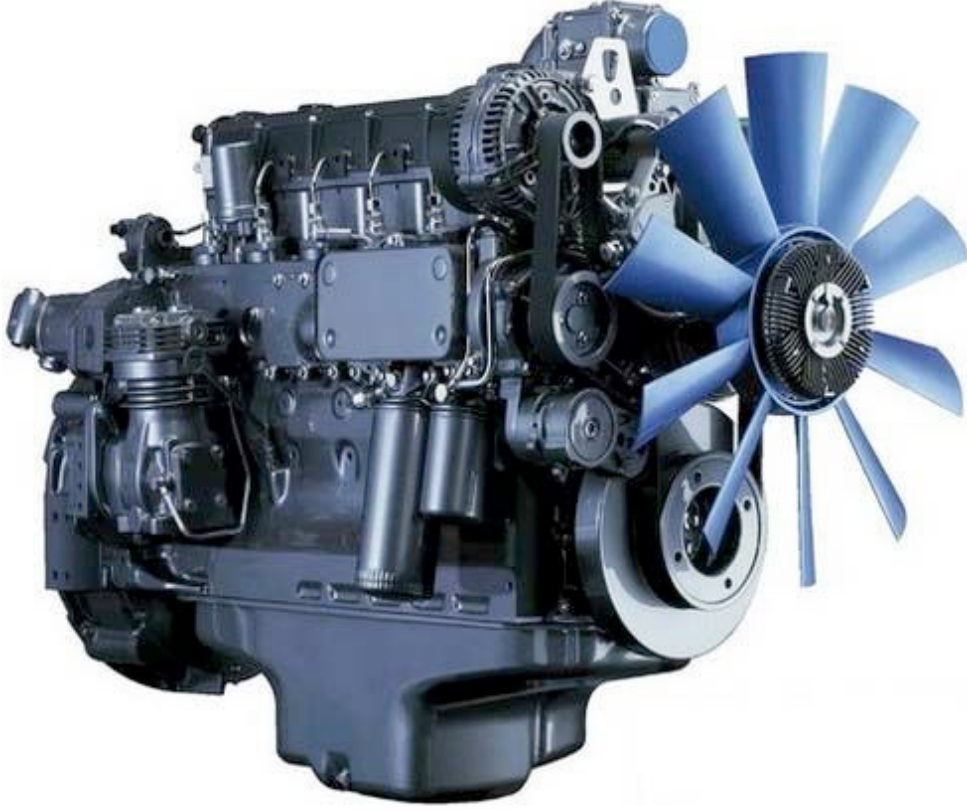















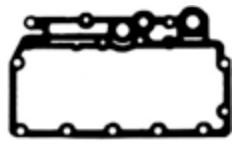
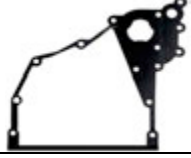















SECTION



Dortrenk Turizm Gayr. Mot.Tas.San. ve Tic. Ltd.Şti.
Tax Administration & No:
Ikitelli / 313 058 5172
Adress :
Ikitelli O.S.B Dolapdere Sanayi Sitesi 12.Ada No:56
Basaksehir / Istanbul / Turkiye
Tel :+90 (212) 243 02 03 Fax: +90 (212) 355 02 42
Email: bilgi@otobusyedekparca.com

01-2017

COBRA.GÜLERYÜZ.DEUTZ.TEZELLER

				
1013.080	1013.060 (4 Cylinder)	2012.080		
				
222.070	222.071	1013.010	222.011	222.602
				
1013.011	222.131	1013.072	222.607	222.604
				
222.201	222.202	222.203	222.204	222.205
				
222.150	222.151	222.152	222.160	442.501
				
222.072	222.075	222.261	222.401	222.403
				
222.603	222.606	222.605		



Dortrenk Turizm Gayr. Mot.Tas.San. ve Tic. Ltd.Şti.
Tax Administration & No:
 Ikitelli / 313 058 5172
Address :
 Ikitelli O.S.B Dolapdere Sanayi Sitesi 12.Ada No:56
 Basaksehir / Istanbul / Turkiye
Tel :+90 (212) 243 02 03 Fax: +90 (212) 355 02 42
Email: bilgi@otobusyedekparca.com

01-2017

COBRA-GÜLERYÜZ-DEUTZ-TEZELLER BF-4M-1012 / BF-4M-1013













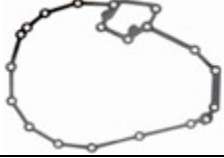

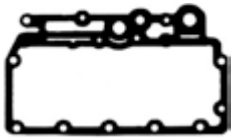















IMSP Ref.	Orj. Ref.	DESCRIPTION	Unit
1013.102		Half Set Gasket (4 Cylinder)	Set.
1013.104		Half Set Gasket (4 Cylinder-Rubber Stamp)	Set.
1013.060		Oil Pan Gasket (4 Cyl.)	Pcs.
222.070		Gasket (Cobra)	Pcs.
222.071		Gasket (1013 Deutz 4 Cylinder)	Pcs.
1013.072		Gasket	Pcs.
222.072		Gasket	Pcs.
222.075		Gasket	Pcs.
1013.080		Valve Cover Gasket	Pcs.
2012.080		Valve Cover Gasket	Pcs.
1013.083		Valve Cover Gasket	Pcs.
2012.083		Valve Cover Gasket	Pcs.
222.083		Valve Cover Gasket	Pcs.
1013.010		Eccentric Cover Gasket (1013 Deutz)	Pcs.
1013.011		Carrier Gasket	Pcs.
222.011		Gasket (Cobra)	Pcs.
222.131		Water Pump Gasket (1013-Cobra)	Pcs.
222.150		Intake Manifold Gasket	Pcs.
222.151		Intake Manifold Search Gasket	Pcs.
222.152		Intake Manifold Top Gasket	Pcs.
222.160		Exhaust Gasket (Nbr Metal)	Pcs.
222.161		Exhaust Gasket (Nbr Metal)	Pcs.
222.162		Exhaust Gasket	Pcs.
222.200		Guanor Gasket Set	Set.
222.201		Guanor Gasket	Pcs.
222.202		Guanor Gasket	Pcs.
222.203		Guanor Gasket	Pcs.
222.204		Guanor Gasket	Pcs.
222.205		Guanor Gasket	Pcs.
222.261		Gasket	Pcs.
442.501		Turbine Gasket (Cobra)	Pcs.
222.602		Injektör Billet Rubber	Pcs.
222.603		Turbo O-ring (40 x 6 Fkm)	Pcs.
222.604		Injektör Billet Rubber	Pcs.
222.605		Injektör Pump Rubber	Pcs.
222.606		Turbo O-ring (50 x 6 Fkm)	Pcs.
222.607		Rubber (1013 Deutz)	Pcs.



Dortrenk Turizm Gayr. Mot.Tas.San. ve Tic. Ltd.Şti.
Tax Administration & No:
Ikitelli / 313 058 5172
Adress :
Ikitelli O.S.B Dolapdere Sanayi Sitesi 12.Ada No:56
Basaksehir / Istanbul / Turkiye
Tel :+90 (212) 243 02 03 Fax: +90 (212) 355 02 42
Email: bilgi@otobusyedeckparca.com

01-2017

COBRA.GÜLERYÜZ.DEUTZ.TEZELLER

				
222.060 (6 Silindir)	222.080	1013.011		
				
222.070	222.071	1013.010	222.011	222.152
				
1013.072	222.131	222.204	222.205	222.607
				
222.201	222.202	222.203	222.602	222.604
				
222.150	222.151	222.403	222.160	442.501
				
222.072	222.075	222.261	222.401	
				
222.603	222.606	222.605		



Dortrenk Turizm Gayr. Mot.Tas.San. ve Tic. Ltd.Şti.
Tax Administration & No:
Ikitelli / 313 058 5172
Address :
Ikitelli O.S.B Dolapdere Sanayi Sitesi 12.Ada No:56
Basaksehir / Istanbul / Turkiye
Tel :+90 (212) 243 02 03 Fax: +90 (212) 355 02 42
Email: bilgi@otobusyedekparca.com

01-2017

COBRA-GÜLERYÜZ-DEUTZ-TEZELLER			
DEUTZ BF-6M-1012 / BF-6M-1013 / BF-6M-2012 C			
IMSP Ref.	Orj. Ref.	DESCRIPTION	Unit
222.102		Half Set Gasket (6 Cyl.)	Set.
222.104		Half Set Gasket (6 Cylinder – Rubber Stamp)	Set.
222.060		Oil Pan Gasket (6 Cyl.)	Pcs.
222.070		Gasket (Cobra)	Pcs.
222.071		Gasket (1013 Deutz 4 Cyl.)	Pcs.
1013.072		Gasket	Pcs.
222.072		Gasket	Pcs.
222.075		Gasket	Pcs.
222.080		Valve Cover Gasket	Pcs.
1013.083		Valve Cover Gasket	Pcs.
2012.083		Valve Cover Gasket	Pcs.
222.083		Valve Cover Gasket	Pcs.
1013.010		Gasket (1013 Deutz)	Pcs.
1013.011		Gasket	Pcs.
222.011		Gasket (Cobra)	Pcs.
222.131		Water Pump Gasket (1013-Cobra)	Pcs.
222.150		Intake Manifold Gasket	Pcs.
222.151		Intake Manifold Gasket	Pcs.
222.152		Intake Manifold Gasket	Pcs.
222.160		Exhaust Gasket (Nbr Metal)	Pcs.
222.161		Exhaust Gasket	Pcs.
222.162		Exhaust Gasket	Pcs.
222.200		Guanor Gasket Set	Set.
222.201		Guanor Gasket	Pcs.
222.202		Guanor Gasket	Pcs.
222.203		Guanor Gasket	Pcs.
222.204		Guanor Gasket	Pcs.
222.205		Guanor Gasket	Pcs.
222.261		Gasket	Pcs.
442.501		Turbine Gasket (Cobra)	Pcs.
222.602		Injektör Billet Rubber	Pcs.
222.603		Turbo O-ring (40 x 6 Fkm)	Pcs.
222.604		Injektör Billet Rubber	Pcs.
222.605		Injektör Pump Rubber	Pcs.
222.606		Turbo O-ring (50 x 6 Fkm)	Pcs.
222.607		Rubber (1013 Deutz)	Pcs.



Dortrenk Turizm Gayr. Mot.Tas.San. ve Tic. Ltd.Şti.

Tax Administration & No:

Ikitelli / 313 058 5172

Adress :

Ikitelli O.S.B Dolapdere Sanayi Sitesi 12.Ada No:56
Basaksehir / Istanbul / Turkiye

Tel :+90 (212) 243 02 03 Fax: +90 (212) 355 02 42

Email: bilgi@otobusyedekparca.com

01-2017



Dortrenk Turizm Gayr. Mot.Tas.San. ve Tic. Ltd.Şti.

Tax Administration & No:

Ikitelli / 313 058 5172

Adress :

Ikitelli O.S.B Dolapdere Sanayi Sitesi 12.Ada No:56

Basaksehir / Istanbul / Turkiye

Tel :+90 (212) 243 02 03 Fax: +90 (212) 355 02 42

Email: bilgi@otobusyedeckparca.com

01-2017

FOR FORD

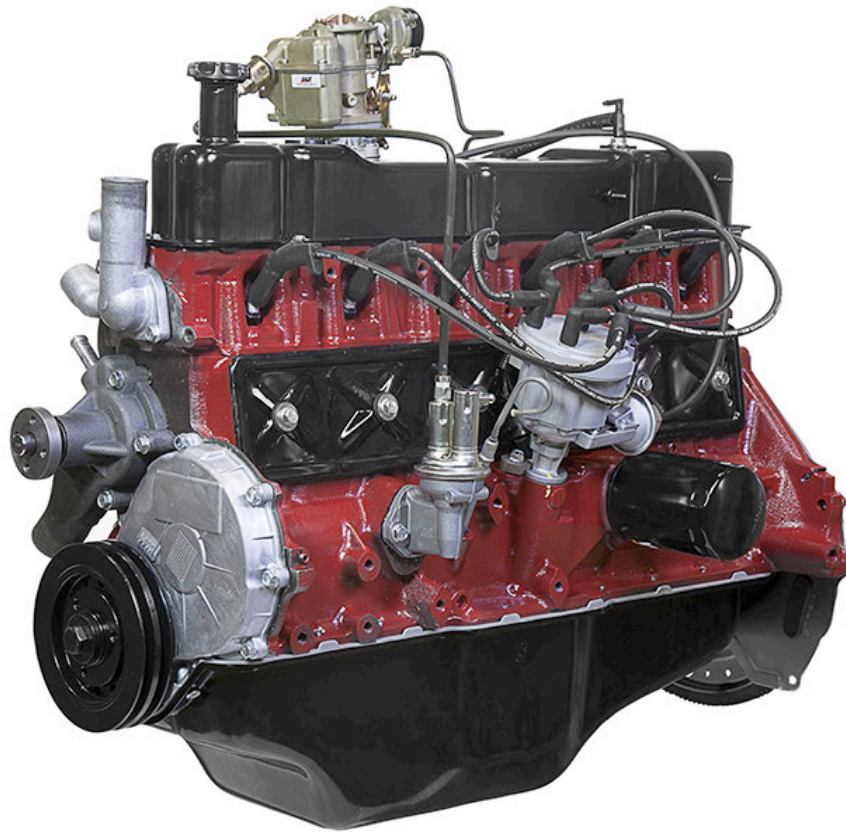

SECTION



Dortrenk Turizm Gayr. Mot.Tas.San. ve Tic. Ltd.Şti.

Tax Administration & No:

Ikitelli / 313 058 5172

Address :

Ikitelli O.S.B Dolapdere Sanayi Sitesi 12.Ada No:56











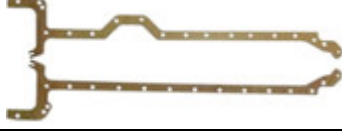



Basaksehir / Istanbul / Turkiye

Tel :+90 (212) 243 02 03 Fax: +90 (212) 355 02 42

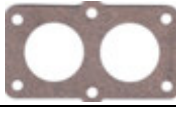
Email: bilgi@otobusyedeckparca.com

01-2017

For FORD D.1210 2704.2713 6 Cyl.

			
2520.060	2520.080	2520.010	2520.112
			
2520.131	2520.132	2520.133	2520.160
			
2520.303	2520.260	2520.305	2520.306
			
2520.302	2520.308	2520.261	2520.203



Dortrenk Turizm Gayr. Mot.Tas.San. ve Tic. Ltd.Şti.

Tax Administration & No:

Ikitelli / 313 058 5172

Adress :

Ikitelli O.S.B Dolapdere Sanayi Sitesi 12.Ada No:56

Basaksehir / Istanbul / Turkiye

Tel :+90 (212) 243 02 03 Fax: +90 (212) 355 02 42

Email: bilgi@otobusyedeckparca.com

01-2017











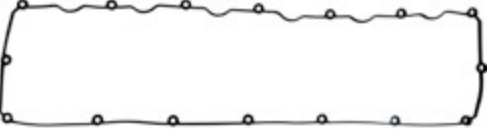

Ford D-1210 2704-2713 6 Cyl.









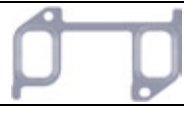

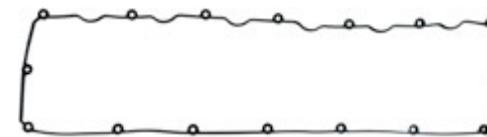

IMSP REF.	ORJ. REF.	DESCRIPTION	Unit
2520-102		Half Set Gasket	Set.
2520-060	826F6781 BBT	Oil Pan Gasket	Pcs.
2520-080	826F 6584 EAA	Valve Cover Gasket	Pcs.
2520-010	16T6K012 AA	Front Cover Gasket	Pcs.
2520-112	826F6018EAA	Time Gear Cover Gasket	Pcs.
2520-131		Water Pump Gasket	Pcs.
2520-132	826F8K563 EAB	Water Pump Gasket	Pcs.
2520-133		Water Pump Gasket	Pcs.
2520-160	1418493	Exhaust Manifold Gasket	Pcs.
2520-203	826F 8K530 EAA	Water Inlet Connection Gasket	Pcs.
2520-260	813F 9K462EAA	Thermostat Nest Gasket	Pcs.
2520-261	723F8587 AAA	Thermostat Nest Gasket	Pcs.
2520-302		Gasket	Pcs.
2520-303		Gasket	Pcs.
2520-305	2700E2946B	Compressor Vacumm Gasket	Pcs.
2520-306	OT2700E9374	Fuel-Oil Pump Gasket	Pcs.
2520-308		Gasket	Pcs.



Dortrenk Turizm Gayr. Mot.Tas.San. ve Tic. Ltd.Şti.
Tax Administration & No:
 Ikitelli / 313 058 5172
Adress :
 Ikitelli O.S.B Dolapdere Sanayi Sitesi 12.Ada No:56
 Basaksehir / Istanbul / Turkiye
Tel :+90 (212) 243 02 03 Fax: +90 (212) 355 02 42
Email: bilgi@otobusyedekparca.com

01-2017

For FORD	CARGO TURBO INTERCOOL PS-2400 DD-NM2400 DD 7.3 LT DIZEL 2524/3230/3430 6CYL				
					
3230.070	3230.072		3230.071		
					
3230.131	3230.132	3230.301	3230.502	3230.501	
					
3230.403	3230.402	3230.401	3230.160	3230.161	

For FORD	CARGO TURBO INTERCOOL PS-2400 DD-NM2400 DD 7.3 LT DIZEL 2524/3230/3430 6CYL				
					
3230.070	3230.073		3230.071		
					
3230.131	3230.132	3230.301	3230.502	3230.501	
					
3230.403	3203.402	3230.401	3230.160	3230.161	



Dortrenk Turizm Gayr. Mot.Tas.San. ve Tic. Ltd.Şti.

Tax Administration & No:

Ikitelli / 313 058 5172

Adress :

Ikitelli O.S.B Dolapdere Sanayi Sitesi 12.Ada No:56

Basaksehir / Istanbul / Turkiye

Tel :+90 (212) 243 02 03 Fax: +90 (212) 355 02 42

Email: bilgi@otobusyedekparca.com

01-2017

FOR FORD

IMSP REF.	ORJ REF	DESCRIPTION	Unit	
3230.070		Valve Cover Gasket	Pcs.	
3230.071		Intake Manifold Gasket	Pcs.	
3230.072		Oil Radiator Gasket	Pcs.	
3230.073		Oil Radiator Gasket	Pcs.	
3230.131		Gasket	Pcs.	
3230.132		Gasket	Pcs.	
3230.301		Gasket	Pcs.	
3230.502		Gasket	Pcs.	
3230.501		Gasket	Pcs.	
3230.403		Gasket	Pcs.	
3230.402		Gasket	Pcs.	
3230.401		Gasket	Pcs.	
3230.160		Gasket	Pcs.	
3230.161		Gasket	Pcs.	



Dortrenk Turizm Gayr. Mot.Tas.San. ve Tic. Ltd.Şti.

Tax Administration & No:

Ikitelli / 313 058 5172

Adress :

Ikitelli O.S.B Dolapdere Sanayi Sitesi 12.Ada No:56
Basaksehir / Istanbul / Turkiye

Tel :+90 (212) 243 02 03 Fax: +90 (212) 355 02 42

Email: bilgi@otobusyedekparca.com

01-2017



Dortrenk Turizm Gayr. Mot.Tas.San. ve Tic. Ltd.Şti.

Tax Administration & No:

Ikitelli / 313 058 5172

Adress :

Ikitelli O.S.B Dolapdere Sanayi Sitesi 12.Ada No:56

Basaksehir / Istanbul / Turkiye

Tel :+90 (212) 243 02 03 Fax: +90 (212) 355 02 42

Email: bilgi@otobusyedekparca.com

01-2017

COMPRESSOR



SECTION



Dortrenk Turizm Gayr. Mot.Tas.San. ve Tic. Ltd.Şti.
Tax Administration & No:
 Ikitelli / 313 058 5172
Adress :
 Ikitelli O.S.B Dolapdere Sanayi Sitesi 12.Ada No:56
 Basaksehir / Istanbul / Turkiye
Tel :+90 (212) 243 02 03 Fax: +90 (212) 355 02 42
Email: bilgi@otobusyedekparca.com

01-2017

001.100		IVECO 99436216 / WABCO9111450600	
İmsp.Ref.	001.100		
DESCRIPTION	Compressor Repair Kit		
Orj. Ref.			

002.100		SCANIA 1722015 1421091 KNORR.BREMS	
İmsp.Ref.	002.100	002.100-1	
DESCRIPTION	Compressor Repair Kit	Compressor Repair Kit Nbr	
Orj. Ref.			

CUMMINS		DEUTZ KNORR.BREMS (LK.3852.3887) CUMMINS		
003.100				
İmsp.Ref.	003.1000	003.1001	003.100.2	003.100.1
DESCRIPTION	Compressor Cylinder Cover	Valve Plate Kit	Compressor Repair Kit	Compressor Repair Kit Nbr
Orj. Ref.				

004.100		For Mercedes.Benz AXOR 906 906 130 49 15.906 130 51 15	
		WABBCO 4111540040 . 4111540050	
İmsp.Ref.	004.1000	004.100	004.100-1
DESCRIPTION	Compressor Cylinder Cover	Compressor Repair Kit	Compressor Repair Kit Nbr
Orj. Ref.		000 130 68 15	000 130 68 15



Dortrenk Turizm Gayr. Mot.Tas.San. ve Tic. Ltd.Şti.

Tax Administration & No:

Ikitelli / 313 058 5172

Adress :

Ikitelli O.S.B Dolapdere Sanayi Sitesi 12.Ada No:56
Basaksehir / Istanbul / Turkiye

Tel :+90 (212) 243 02 03 Fax: +90 (212) 355 02 42

Email: bilgi@otobusyedeckparca.com

01-2017



Dortrenk Turizm Gayr. Mot.Tas.San. ve Tic. Ltd.Şti.
Tax Administration & No:
 Ikitelli / 313 058 5172
Adress :
 Ikitelli O.S.B Dolapdere Sanayi Sitesi 12.Ada No:56
 Basaksehir / Istanbul / Turkiye
Tel :+90 (212) 243 02 03 Fax: +90 (212) 355 02 42
Email: bilgi@otobusyedeckparca.com

01-2017

005.100		
SCANIA 1537794 LK.4939 K005801		
K.K.N BUS		
İmsp.Ref.	005.100	
Description	Compressor Repair Kit	
Orj. Ref.		

006.100		
For Mercedes.Benz		
WABCO 411 146 0030		
İmsp.Ref.	006.100	
Description	Compressor Repair Kit	
Orj. Ref.		

007.100		
BMC FATİH		
FORD 2520 CARGO		
İmsp.Ref.	007.100	
Description	Compressor Repair Kit	
Orj. Ref.		

008.100		For Mercedes.Benz		
		AXOR 906 130 32 15 Wabco 4126360000.4126360030		
İmsp.Ref.	008.1000	029.1008	008.100	008.100-1
DESCRIPTI ON	Compressor Head Cylinder	Compressor Flange	Compressor Repair Kit	Compressor Repair Kit Nbr.
Orj. Ref.	911 556 656 2		000 130 89 15	001 130 15 15
Unit \$				
İmsp.Ref.	008.100-2			
DESCRIPTI ON	Compressor Repair Kit Nbr			
Orj. Ref.	001 130 15 15			



Dortrenk Turizm Gayr. Mot.Tas.San. ve Tic. Ltd.Şti.
Tax Administration & No:
 Ikitelli / 313 058 5172
Adress :
 Ikitelli O.S.B Dolapdere Sanayi Sitesi 12.Ada No:56
 Basaksehir / Istanbul / Turkiye
Tel :+90 (212) 243 02 03 Fax: +90 (212) 355 02 42
Email: bilgi@otobusyedekparca.com

01-2017

009.100		
İmsp.Ref.	009.100	
DESCRIPTION	Compressor Repair Kit	
Orj. Ref.		

010.100		For Mercedes.Benz	
İmsp.Ref.	010.1000	010.100	010.100-1
DESCRIPTION	Compressor Head Cylinder	Compressor Repair Kit	Compressor Repair Kit Nbr
Orj. Ref.	000 130 25 15	001 130 28 15	001 130 28 15
İmsp.Ref.	010.1008	010.022	010.100-2
DESCRIPTION	Compressor Flange	Intermediate Cover Plate	Compressor Repair Kit NBR
Orj. Ref.	000 131 29 32		001 130 28 15

012.100		For Mercedes.Benz Ø75 OM.366 / 25.17 000 130 16 15 / 000 130 99 80		
İmsp.Ref.	012.1002	012.1001	012.1011	012.1010
DESCRIPTION	Compressor Head Cylinder	Valve Plate Kit	Cylinder Liner 75Ø	Cylinder Liner Set 75Ø
Orj. Ref.	000 131 27 19	000 130 79 15	000 131 42 02	
İmsp.Ref.	012.100	012.1005	012.1006	012.1007
DESCRIPTION	Compressor Repair Kit	Piston & Rings	Piston Rod	Grankshaft
Orj. Ref.	000 13016 15	000 130 1117	000 131 18 17	000 131 42 16



Dortrenk Turizm Gayr. Mot.Tas.San. ve Tic. Ltd.Şti.
Tax Administration & No:
 Ikitelli / 313 058 5172
Address :
 Ikitelli O.S.B Dolapdere Sanayi Sitesi 12.Ada No:56
 Basaksehir / Istanbul / Turkiye
Tel :+90 (212) 243 02 03 Fax: +90 (212) 355 02 42
Email: bilgi@otobusyedeckparca.com

01-2017

014.100 / Ø88		For Mercedes.Benz OM.366 LA / 25.21					
							
İmsp.Ref.	014.9401	014.1000	014.1001	014.1002		014.1002	
Description	Compressor	Complete Cover	Plate	Top Cover		Top Cover	
Orj. Ref.	004 131 94 01	000 131 29 19	000 130 05 36	000 131 45 19		000 131 45 19	
							
İmsp.Ref.	014.100	014.100.2	014.1006	014.1007		014.1007	
Description	Comp. Repair Kit	Compressor Repair Kit Felt	Piston Rod	Grankshaft		Grankshaft	
Orj. Ref.	000 130 30 15	000 130 30 15	000 131 18 17				
							
İmsp.Ref.	014.1015	014.1005	014.1010	014.1011		014.1011	
Description	Flan	Piston Segment	Cylinder Liner Set	Cylinder Liner		Cylinder Liner	
Orj. Ref.	51 45130 0019	000 131 93 11	004 034 00 09	004 034 00 09		004 034 00 09	

015.100		For Mercedes.Benz Ø90 O.302 .360 / OM.355 001 131 52 01 / 000 586 27 13 / 001 131 55 01					
							
İmsp.Ref.	015.1000	015.1001	015.1002	015.1005		015.1005	
DESCRIPTION	Compressor Cylinder Cover	Valve Plate Kit	Cylinder Head	Piston & Rings		Piston & Rings	
Orj. Ref.		000 130 79 15	000 131 31 19	403 130 0517		403 130 0517	
							
İmsp.Ref.	015.100	015.1010	015.1011	015.1006		015.1006	
DESCRIPTION	Compressor Repair Kit	Cylinder Liner Set	Cylinder Liner	Piston Rod		Piston Rod	
Orj. Ref.	411 034 005 2	000 130 0208	000 131 3602	403 130 2816		403 130 2816	



Dortrenk Turizm Gayr. Mot.Tas.San. ve Tic. Ltd.Şti.
Tax Administration & No:
 Ikitelli / 313 058 5172
Adress :
 Ikitelli O.S.B Dolapdere Sanayi Sitesi 12.Ada No:56
 Basaksehir / Istanbul / Turkiye
Tel :+90 (212) 243 02 03 Fax: +90 (212) 355 02 42
Email: bilgi@otobusyedekparca.com

01-2017

016.100		For Mercedes.Benz Ø90 V/6.V/8 DRY TYPE 402 130 00 20 / 402 130 01 20		
İmsp.Ref.	016.1000	016.1001	016.1002	021.1005
DESCRIPTION	Compressor Head Cylinder Cover	Valve Plate Kit	Compressor Top Cover	Piston & Rings
Orj. Ref.	000 130 2619	402 130 0320	407 131 0519	403 130 0517
İmsp.Ref.	016.100	021.1010	021.1011	016.1007
DESCRIPTION	Compressor Repair Kit	Cylinder Liner Set	Cylinder Liner	Grankshaft
Orj. Ref.	402 130 0220	403 130 0502	403 131 2002	403 131 0716
İmsp.Ref.	016.1008	021.1006		
DESCRIPTION	Burç	Piston Kolu		
Orj. Ref.	403 130 1645	403 130 2816		

017.100		For Mercedes.Benz Ø90 OM.303 / V/8 OM.402.422.442 SULU TİP 442 130 00 20 / 402 130 00 20		
İmsp.Ref.	017.1000	017.1001	021.1002	
DESCRIPTION	Compressor Head Cylinder Cover	Valve Plate Kit	Compressor Head	
Orj. Ref.	407 130 0719	442 130 0220	407 130 0519	
İmsp.Ref.	017.100	021.1006	021.1007	
DESCRIPTION	Compressor Repair Kit	Piston Rod	Grankshaft	
Orj. Ref.	442 130 0020	403 130 2816	403 131 0716	



Dortrenk Turizm Gayr. Mot.Tas.San. ve Tic. Ltd.Şti.
Tax Administration & No:
 Ikitelli / 313 058 5172
Address :
 Ikitelli O.S.B Dolapdere Sanayi Sitesi 12.Ada No:56
 Basaksehir / Istanbul / Turkiye
Tel :+90 (212) 243 02 03 Fax: +90 (212) 355 02 42
Email: bilgi@otobusyedekparca.com

01-2017

018.100		M A N.281 / 19.422 / S 2000 WATER TYPE 000 130 29 15 / 51 54000 7140		
İmsp.Ref.	018.1000	018.1001	018.1002	021.1005
DESCRIPTION	Compressor Head Cylinder Cover	Valve Plate Kit	Cylinder Head	Piston & Rings
Orj. Ref.	51 54114 6045	51 54114 6050	51 54114 6050	403 130 0517
İmsp.Ref.	018.100	018.100-2	021.1006	018.029
DESCRIPTION	Compressor Repair Kit	Compressor Repair Kit	Piston Rod	Gasket
Orj. Ref.	000 130 2915		403 130 2816	51 96101 0048
İmsp.Ref.	023.1010	023.1011	018.1007	
DESCRIPTION	Cylinder Liner Set	Cylinder Liner	Grankshaft	
Orj. Ref.	51.54105.6008		51 54113 5033	

019.100		For Mercedes.Benz UNIMOG 000 130 79 15 / 51.54101.72 10		
İmsp.Ref.	019.1000	019.1001	019.1002	019.1005
DESCRIPTION	Comp. Cylinder Cover	Valve Plate Kit	Cylinder Head	Piston & Rings
Orj. Ref.				81 54119 0004
İmsp.Ref.	019.100	019.100.1		
DESCRIPTION	Compressor Repair Kit	Compressor Repair Kit Felt		
Orj. Ref.	000 130 79 15	000 130 79 15		



Dortrenk Turizm Gayr. Mot.Tas.San. ve Tic. Ltd.Şti.
Tax Administration & No:
 Ikitelli / 313 058 5172
Address :
 Ikitelli O.S.B Dolapdere Sanayi Sitesi 12.Ada No:56
 Basaksehir / Istanbul / Turkiye
Tel :+90 (212) 243 02 03 Fax: +90 (212) 355 02 42
Email: bilgi@otobusyedeckparca.com

01-2017

020.100		
75Ø DEUTZ - M A N - L-1300 - UNIMOG		
İmp. Ref.	020.100	
DESCRIPTION	Compressor Repair Kit	
Orj. Ref.		

021.100		For Mercedes.Benz Ø90 OM.403 OM.442 / LA 442 130 02 20 /442 130 07 20		
İmp. Ref.	021.1000	021.1001	021.1002	021.1005
DESCRIPTION	Compressor Cylinder Cover	Valve Plate Kit	Cylinder Head	Piston & Rings
Orj. Ref.	447 130 00 19	442 130 0720	407 130 0519	403 130 0517
		NBR SACLİ		
İmp. Ref.	021.100	021.100-1	021.1010	021.1011
DESCRIPTION	Compressor Repair Kit	Compressor Repair Kit	Cylinder Liner Set	Cylinder Liner
Orj. Ref.	442 130 0020	442 130 0020	403 130 0502	403 131 2002



Dortrenk Turizm Gayr. Mot.Tas.San. ve Tic. Ltd.Şti.
Tax Administration & No:
 Ikitelli / 313 058 5172
Address :
 Ikitelli O.S.B Dolapdere Sanayi Sitesi 12.Ada No:56
 Basaksehir / Istanbul / Turkiye
Tel :+90 (212) 243 02 03 Fax: +90 (212) 355 02 42
Email: bilgi@otobusyedekparca.com

01-2017

022.100		For Mercedes.Benz 3031. 441 130 00 20 Ø100		
İmsp.Ref.	022.1000	022.1001	022.1002	022.1005
DESCRIPTION	Compressor Cylinder Cover	Valve Plate Kit	Cylinder Head	Piston & Rings
Orj. Ref.	442 130 3419	441 130 0220	442 131 0119	51 54119 6001
Unit \$				
İmsp.Ref.	022.100	022.100-1	022.1010	022.1011
DESCRIPTION	Compressor Repair Kit	Compressor Repair Kit	Cylinder Liner Set	Cylinder Liner
Orj. Ref.	441 130 0020	441 130 0020	441 130 0008	442 131 0120
İmsp.Ref.	022.1008	022.1006	022.1007	
DESCRIPTION	Komp. Burç	Piston Kolu	Krank	
Orj. Ref.	403 130 0145	442 131 0017	442 130 0114	



Dortrenk Turizm Gayr. Mot.Tas.San. ve Tic. Ltd.Şti.
Tax Administration & No:
 Ikitelli / 313 058 5172
Adress :
 Ikitelli O.S.B Dolapdere Sanayi Sitesi 12.Ada No:56
 Basaksehir / Istanbul / Turkiye
Tel :+90 (212) 243 02 03 Fax: +90 (212) 355 02 42
Email: bilgi@otobusyedekparca.com

01-2017

023.100 90Ø		MAN / TG-A 410 / 460 WATER TYPE		
		51.54114.6081 TGA6 . TGA18 . TGA22 . TGM22 . TGA28 4120908012 CYLINDER HEAD 4120908022.51541006003.51541006007.51541006009 51541007010.51541007028.51541007033.51541007066		
İmsp.Ref.	023.1000	023.100	023.100-1 (Nbr)	021.1005
DESCRIPTION	Comp. Cylinder Cover	Compressor Repair Kit	Compressor Repair Kit	Piston & Rings
Orj. Ref.	51 54114 6081	51 54114 6081		403 130 0517
İmsp.Ref.	023.1010	023.1011		
DESCRIPTION	Cylinder Liner Set	Cylinder Liner		
Orj. Ref.	402 130 0608	402 130 0308		

024.100 85Ø		For Mercedes.Benz Ø85 9061300615		
				029.034 VE PLEYTLİ 9115140010 85mm V2 9115140020 85mm V2
İmsp.Ref.	024.1000	024.100	024.1005	
DESCRIPTION	Comp. Cylinder Cover	Compressor Repair Kit	Piston & Rings	
Orj. Ref.	81 54114 6022	81 54101 6054	81 54119 6040	



Dortrenk Turizm Gayr. Mot.Tas.San. ve Tic. Ltd.Şti.
Tax Administration & No:
 Ikitelli / 313 058 5172
Address :
 Ikitelli O.S.B Dolapdere Sanayi Sitesi 12.Ada No:56
 Basaksehir / Istanbul / Turkiye
Tel :+90 (212) 243 02 03 Fax: +90 (212) 355 02 42
Email: bilgi@otobusyedekparca.com

01-2017

025.100		For Mercedes.Benz Ø100 ACTROS. OM.501.502 LA SETRA / TRAVEGO AXLE			
		541 130 02 20 . 541 130 06 20			
İmsp.Ref.	025.1000	025.1000.1	025.1002	025.1003	
DESCRIPTION	Compressor Cylinder Cover	Compressor Cylinder Cover	Cylinder Head	Cylinder Head Pipe	
Orj. Ref.	541 130 07 19	541 131 10 19	541 131 12 19	541 131 06 19	
Unit \$					
İmsp.Ref.	025.1001	025.1010	025.1011	022.1005	
DESCRIPTION	Valve Plate Kit	Cylinder Liner Set	Cylinder Liner	Piston & Rings	
Orj. Ref.	541 130 06 20	541 130 00 08		51 54119 6001	
Unit \$					
İmsp.Ref.	025.100	025.100-1	025.1008	025-1009	
DESCRIPTION	Compressor Repair Kit	Compressor Repair Kit Nbr	Crankshaft Flange	Flange	
Orj. Ref.	541 130 06 20	541 130 06 20	541 131 01 42	541 132 02 45	
Unit \$					
İmsp.Ref.	022.1006	022.1007	025.1008.1		
DESCRIPTION	Piston Rod	Grankshaft	Compressor Flange		
Orj. Ref.	442 131 00 17	442 130 0114	541 131 01 42		
Unit \$					



Dortrenk Turizm Gayr. Mot.Tas.San. ve Tic. Ltd.Şti.
Tax Administration & No:
 Ikitelli / 313 058 5172
Address :
 Ikitelli O.S.B Dolapdere Sanayi Sitesi 12.Ada No:56
 Basaksehir / Istanbul / Turkiye
Tel :+90 (212) 243 02 03 Fax: +90 (212) 355 02 42
Email: bilgi@otobusyedekparca.com

01-2017

026.100		For Mercedes.Benz OM.345.447 / CİTARO.EUROBU.EURO 1 447 130 28 15		
				
İmsp.Ref.	026.1000	026.1001	026.1002	026.100
DESCRIPTION	Compressor Cylinder Cover	Valve Plate Kit	Cylinder Head	Compressor Repair Kit
Orj. Ref.	442 131 71 19	442 130 11 20	442 131 05 19	442 130 28 15
Unit \$				
				
İmsp.Ref.	026.100.1	022.1008	022.1010	022.1011
DESCRIPTION	Compressor Repair Kit Nbr.Met.	Compressor Flange	Cylinder Liner Set	Cylinder Liner
Orj. Ref.	442 130 28 15	403 130 01 45	441 130 00 08	
Unit \$				
				
İmsp.Ref.	022.1005			
DESCRIPTION	Piston Segment Ø100			
Orj. Ref.	51 54119 6001			



Dortrenk Turizm Gayr. Mot.Tas.San. ve Tic. Ltd.Şti.
Tax Administration & No:
 Ikitelli / 313 058 5172
Address :
 Ikitelli O.S.B Dolapdere Sanayi Sitesi 12.Ada No:56
 Basaksehir / Istanbul / Turkiye
Tel :+90 (212) 243 02 03 Fax: +90 (212) 355 02 42
Email: bilgi@otobusyedekparca.com

01-2017

027.100		For Mercedes.Benz Ø100 SETRA – ACTROS – TRAVEGO OM.501.502 000 130 76 15			
İmsp.Ref.	027.1000	027.1001	027.1002	027.100	
DESCRIPTION	Compressor Cylinder Cover	Valve Plate Kit	Cylinder Head	Compressor Repair Kit	
Orj. Ref.	541 130 27 19	541 130 08 20	541 130 22 19	541 130 76 15	
Unit \$					
İmsp.Ref.	027.100.1	025.1010	025.1011	022.025	
DESCRIPTION	Compressor Repair Kit	Cylinder Liner Set	Cylinder Liner	Piston Segment 100Ø	
Orj. Ref.	541 130 76 15	541 130 00 08		51 54119 6001	
Unit \$					
İmsp.Ref.	025.1008	025-1009	022.1006	022.1007	
DESCRIPTION	Compressor Flange	Flange	Piston Rod	Grankshaft	
Orj. Ref.	541 131 01 42	541 132 02 45	442 131 00 17	442 130 03 14	
Unit \$					



Dortrenk Turizm Gayr. Mot.Tas.San. ve Tic. Ltd.Şti.
Tax Administration & No:
 Ikitelli / 313 058 5172
Address :
 Ikitelli O.S.B Dolapdere Sanayi Sitesi 12.Ada No:56
 Basaksehir / Istanbul / Turkiye
Tel :+90 (212) 243 02 03 Fax: +90 (212) 355 02 42
Email: bilgi@otobusyedeckparca.com

01-2017



028.100		For Mercedes.Benz 85Ø EURO3 / DOUBLE HEAD OM.457 TRAVEGO / 1840 AXOR / CITARO000 130 69 15		
İmsp.Ref.	028.1000	028.1005	028.100	028.100.1
DESCRIPTION	Compressor Cylinder Cover	Piston & Rings	Compressor Repair Kit	Compressor Repair Kit Met.
Orj. Ref.	000 131 52 19	000 130 53 17	000 130 69 15	000 130 69 15
Unit \$				
İmsp.Ref.	028.100.2	029.021		
DESCRIPTION	Compressor Repair Kit NBR	Connection Gasket		
Orj. Ref.	000 130 69 15	457 131 01 80		
Unit \$				



Dortrenk Turizm Gayr. Mot.Tas.San. ve Tic. Ltd.Şti.
Tax Administration & No:
 Ikitelli / 313 058 5172
Address :
 Ikitelli O.S.B Dolapdere Sanayi Sitesi 12.Ada No:56
 Basaksehir / Istanbul / Turkiye
Tel :+90 (212) 243 02 03 Fax: +90 (212) 355 02 42
Email: bilgi@otobusyedekparca.com

01-2017

029.100		For Mercedes.Benz EURO3 AXOR 1840 –TRAVEGO 457 457 130 23 15			
				 Ø85	
İmsp.Ref.	029.2115	029.1000	029.1001	028.1005	
DESCRIPTION	Euro3 Compressor	Compressor Cylinder Cover	Valve Plate	Piston & Rings	
Orj. Ref.	457 130 21 15	001 130 52 19	000 130 50 19	000 130 53 17	
					
İmsp.Ref.	029.100	029.100.1	029.100.2	029.021	
DESCRIPTION	Compressor Repair Kit	Compressor Repair Kit	Compressor Repair Kit Saçlı	Con.	
Orj. Ref.	457 130 23 15	457 130 23 15	457 130 23 15	457 131 01 80	
					
İmsp.Ref.	029.030	029.022	029.1008	029.1009	
DESCRIPTION	Valf Set	Valve Plate	Compressor Flange	Flange	
Orj. Ref.			000 131 29 32		
					
İmsp.Ref.	029.1006	022.1007	029-150		
DESCRIPTION	Piston Rod	Grankshaft	Compressor Rubber		
Orj. Ref.	000 131 29 17	000 131 75 16			

030.100		COMMINS LK3833.3836.3838.3839.3846.3850.3853.3857.3859.3875		
				
İmsp.Ref.	030.1000	030.100	030.100.1	
DESCRIPTION	Comp. Cylinder Cover	Compressor Repair Kit	Compressor Repair Kit	
Orj. Ref.				



Dortrenk Turizm Gayr. Mot.Tas.San. ve Tic. Ltd.Şti.
Tax Administration & No:
 Ikitelli / 313 058 5172
Address :
 Ikitelli O.S.B Dolapdere Sanayi Sitesi 12.Ada No:56
 Basaksehir / Istanbul / Turkiye
Tel :+90 (212) 243 02 03 Fax: +90 (212) 355 02 42
Email: bilgi@otobusyedekparca.com

01-2017

031.100		For Mercedes.Benz		
		Ø85 ATEGO . AXOR / OM.904.906 LA 000 130 68 15		
				
İmsp.Ref.	029.2915	031.1000	031.1003	031.1002
DESCRIPTION	Compressor	Compressor Cylinder Cover	Cylinder Head	Cylinder Head
Orj. Ref.	906 130 29 15	000 130 56 19		
				
İmsp.Ref.	031.100	031.100-1	029.1008	028.1005
DESCRIPTION	Comp. Repair Kit	Compressor Repair Kit	Compressor Flange	Piston & Rings
Orj. Ref.	000 130 68 15	000 130 68 15	000 131 29 32	000 130 53 17
				
İmsp.Ref.	031.1007	029.1006		
DESCRIPTION	Grankshaft	Piston Rod		
Orj. Ref.	000 131 75 16	000 131 29 17		



Dortrenk Turizm Gayr. Mot.Tas.San. ve Tic. Ltd.Şti.
Tax Administration & No:
 Ikitelli / 313 058 5172
Address :
 Ikitelli O.S.B Dolapdere Sanayi Sitesi 12.Ada No:56
 Basaksehir / Istanbul / Turkiye
Tel :+90 (212) 243 02 03 Fax: +90 (212) 355 02 42
Email: bilgi@otobusyedekparca.com

01-2017

032.100 Ø.90		For Mercedes.Benz Ø90 WATER TYPE 51 54000 7079.51 54000 7058		
İmsp.Ref.	032.1000	032.1001	032.1002	021.1005
DESCRIPTION	Comp. Cylinder Cover	Valve Plate Kit	Cylinder Head	Piston & Rings
Orj. Ref.		81.54124.6031		403 130 0517
İmsp.Ref.	032.100	023.1010	023.1011	
DESCRIPTION	Comp. Repair Kit	Cylinder Liner Set	Cylinder Liner	
Orj. Ref.	51 54101 7192	51.54105.6008		

033.100		For Mercedes.Benz EURO3 OM – 457 – AXOR – DOUBLO HEAD TOURISMO Ø85 457 130 12 15 / 457 130 27 15		
İmsp.Ref.	033.1000	033.022	033.100	033.100-1
DESCRIPTION	Comp. Cylinder Cover	Valve Plate	Compressor Repair Kit	Compressor Repair Kit
Orj. Ref.	001 130 08 15		001 130 23 15	001 130 23 15
İmsp.Ref.	029.1008	029.109	033.1007	029.1006
DESCRIPTION	Compressor Flange	Front Bushing	Grankshaft	Piston Rod
Orj. Ref.	000 131 29 32			000 131 29 17
İmsp.Ref.	029.500	028.1005		
DESCRIPTION	Oil Pan Cover	Ø85 Std Piston Set		
Orj. Ref.				



Dortrenk Turizm Gayr. Mot.Tas.San. ve Tic. Ltd.Şti.
Tax Administration & No:
 Ikitelli / 313 058 5172
Address :
 Ikitelli O.S.B Dolapdere Sanayi Sitesi 12.Ada No:56
 Basaksehir / Istanbul / Turkiye
Tel :+90 (212) 243 02 03 Fax: +90 (212) 355 02 42
Email: bilgi@otobusyedekparca.com

01-2017

034.100		M A N / TG.A- EUROPE 463 / 464 Ø100
İmsp.Ref.	034.100	
DESCRIPTION	Compressor Repair Kit	
Orj. Ref.		

035.100		19.460 . 19.463 . 19.464 M A N / Ø100 SULU		
		FOR MAN 51.54114.6073 / 51.54114.6066		
		51541006005 / 4121008052 CYLINDER HEAD SERVICES D28 ENGINE 51541006011 / 51541006013 / 51541006015 / 51541006023 / 51541007003 / 51541007042 / 7033.7249		
İmsp.Ref.	035.1000	035.100	035.100.1	022.1005
DESCRIPTION	Comp. Cylinder Cover	Compressor Repair Kit	Compressor Repair Kit	Piston & Rings
Orj. Ref.	51.54114.6066	51.54114.6067	51.54114.6067	51 54119 6001
İmsp.Ref.	035.1010	035.1011		
DESCRIPTION	Cylinder Liner Set	Cylinder Liner		
Orj. Ref.	51.54105.6021	51.54405.6016		



Dortrenk Turizm Gayr. Mot.Tas.San. ve Tic. Ltd.Şti.
Tax Administration & No:
 Ikitelli / 313 058 5172
Address :
 Ikitelli O.S.B Dolapdere Sanayi Sitesi 12.Ada No:56
 Basaksehir / Istanbul / Turkiye
Tel :+90 (212) 243 02 03 Fax: +90 (212) 355 02 42
Email: bilgi@otobusyedekparca.com

01-2017

036.100		FOR MAN 32.270 HIEX COBRA – IVECO 51.54114.6082		
				<p>4111540010.4123520080 4123520030 9121160000.9121170000</p>
İmsp.Ref.	036.1000	036.100.1		
DESCRIPTION	Comp. Cylinder Cover	Compressor Repair Kit		
Orj. Ref.	51.54114.6082	51 54114 60 82		

037.100		
SAFİR / HYUNDAI BUS		
İmsp.Ref.	037.100	
DESCRIPTION	Compressor Repair Kit	
Orj. Ref.		

038.100		
FOR MERCEDES / UNIMOG		
İmsp.Ref.	038.100	
DESCRIPTION	Compressor Repair Kit	
Orj. Ref.		



039.100		M A N.TG.A / D.2066. 430		
		COMMONRAIL NEOPLAN BUS 2010/2011/2012 LP3977 SEB01795) LP3980 K004489) 51541006047 / 51541006046 / LP3986 K005977) LP3997 LK3994 LK8901 K015410		
İmsp.Ref.	039.1000	039-1001	039.100	039.100.1
DESCRIPTION	Comp. Cylinder Cover	Valve Plate Kit	Compressor Repair Kit	Compressor Repair Kit
Orj. Ref.	51 54114.6084		51.54100.6046	51.54100.6046









Dortrenk Turizm Gayr. Mot.Tas.San. ve Tic. Ltd.Şti.
Tax Administration & No:
 Ikitelli / 313 058 5172
Address :
 Ikitelli O.S.B Dolapdere Sanayi Sitesi 12.Ada No:56
 Basaksehir / Istanbul / Turkiye
Tel :+90 (212) 243 02 03 Fax: +90 (212) 355 02 42
Email: bilgi@otobusyedekparca.com

01-2017

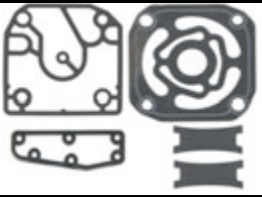
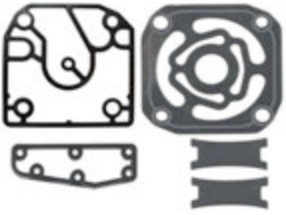
040.100		
For Mercedes.Benz Ø90 Ø75 OM.366 / 25.17 000 130 16 15 / 000 130 99 80		
İmsp.Ref.	040.100	
DESCRIPTION	Compressor Repair Kit.	
Orj. Ref.		

041.100		For Mercedes.Benz Atego.Axor / OM.926 LA. AVRUPA 000 130 74 15	
			
İmsp.Ref.	041.1000	041.100	041.100.1
DESCRIPTION	Compressor Cylinder Cover	Compressor Repair Kit	Compressor Repair Kit
Orj. Ref.	000 131 54 19	000 130 74 15	000 130 74 15

042.100		For Mercedes.Benz SETRA TRAVEGO DİNGİLLİ EURO 4 NEW 541 130 35 19		
				
İmsp.Ref.	042.1000	042.1001	042.1002	042.100
DESCRIPTION	Compressor Cylinder Cover	Valve Plate Kit	Cylinder Head	Compressor Repair Kit
Orj. Ref.	541 130 36 19	541 130 35 19		541 130 35 19
				
İmsp.Ref.	042.100.1	022.1005	042.1010	042.1011
DESCRIPTION	Compressor Repair Kit	Piston & Rings	Cylinder Liner Set	Cylinder Liner
Orj. Ref.	541 130 35 19	51 54119 6001	541 130 01 08	



Dortrenk Turizm Gayr. Mot.Tas.San. ve Tic. Ltd.Şti.
Tax Administration & No:
 Ikitelli / 313 058 5172
Adress :
 Ikitelli O.S.B Dolapdere Sanayi Sitesi 12.Ada No:56
 Basaksehir / Istanbul / Turkiye
Tel :+90 (212) 243 02 03 Fax: +90 (212) 355 02 42
Email: bilgi@otobusyedekparca.com

01-2017

043.100		COBRA / MAN D0826 51.54114.6078 OLD MODEL 81.54901.6014 NEW MODEL		
				
İmsp.Ref.	043.1000	043.1001	043.1002	043.100
DESCRIPTION	Compressor Cylinder Cover	Cylinder Head	Valve Plate Kit	Compressor Repair Kit
Orj. Ref.				51.54114.6078

044.100		For Mercedes.Benz Euro 3 TRAVEGO / CITARO BUS001 131 35 15 . 001 130 15 15		
				
İmsp.Ref.	044.1000	044.100	044.100.1	029.1008
DESCRIPTION	Compressor Cylinder Cover	Compressor Repair Kit	Compressor Repair Kit NBR	Compressor Flange
Orj. Ref.	000 130 55 19	001 130 15 15	001 130 35 15	000 131 29 32

045.100		For Mercedes.Benz ACTROS EUROPE EVOBUS		
				
İmsp.Ref.	045.100	022.1005	042.1010	042.1011
DESCRIPTION	Compressor Repair Kit	Piston & Rings	Cylinder Liner Set	Cylinder Liner
Orj. Ref.		51 54119 6001	541 130 01 08	

046.100	For Mercedes.Benz VOITH COMPRESSOR / 000 900 18 08
----------------	---



Dortrenk Turizm Gayr. Mot.Tas.San. ve Tic. Ltd.Şti.
Tax Administration & No:
 İkitelli / 313 058 5172
Address :
 İkitelli O.S.B Dolapdere Sanayi Sitesi 12.Ada No:56
 Basaksehir / İstanbul / Türkiye
Tel :+90 (212) 243 02 03 Fax: +90 (212) 355 02 42
Email: bilgi@otobusyedekparca.com

01-2017

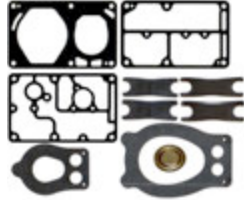

İmsp.Ref.	046.100.1	046.101
DESCRIPTION	Compressor Repair Kit	Compressor Repair Kit
Orj. Ref.	000 900 18 08	

047.100		For Mercedes.Benz Type Ø90 S 200 / 51 54100 7086		
İmsp.Ref.	018.1000	018.1001	018.1002	047.100
DESCRIPTION	Comp. Cylinder Cover	Valve Plate Kit	Compressor Cover	Compressor Repair Kit
Orj. Ref.	51 54114 6045	51 54114 6050	51 54114 6050	51 54100 7086
İmsp.Ref.	021.1005	023.1010	023.1011	
DESCRIPTION	Piston Segment	Cylinder Liner Set Ø90	Cylinder Liner	
Orj. Ref.	403 130 0517			

048.100		MAN 2066 STARLINER BUS 51.54114.60 51541007117.7121 WATER	
İmsp.Ref.	048.1000	048.100	048.100.1
DESCRIPTION	Compressor Cylinder Cover	Compressor Repair Kit	Compressor Repair Kit-Nbr
Orj. Ref.	51.54124.6003	51.54114.6049	51.54114.6049



Dortrenk Turizm Gayr. Mot.Tas.San. ve Tic. Ltd.Şti.
Tax Administration & No:
 Ikitelli / 313 058 5172
Address :
 Ikitelli O.S.B Dolapdere Sanayi Sitesi 12.Ada No:56
 Basaksehir / Istanbul / Turkiye
Tel :+90 (212) 243 02 03 Fax: +90 (212) 355 02 42
Email: bilgi@otobusyedekparca.com

01-2017

İmsp.Ref.	048.1001	048.100.2	
DESCRIPTION	Valve Plate Kit	Compressor Repair Kit-Nbr	
Orj. Ref.	51.54124.6003	51.54114.6049	

049.100		For Mercedes.Benz AXOR 2010/2012 1840.4140 EURO4/5 457 130 47 15	
İmsp.Ref.	049.1000	049.100	049.100.1
DESCRIPTION	Compressor Cylinder Cover	Compressor Repair Kit	Compressor Repair Kit
Orj. Ref.	000 130 55 19	000 130 49 15	000 130 49 15
İmsp.Ref.	049.100.2	029.021	029.1008
DESCRIPTION	Compressor Repair Kit	Connection Gasket	Compressor Flange
Orj. Ref.	000 130 49 15	457 131 01 80	000 131 29 32



050.100		KNORR PERKINS RVI SCANIA VOLVO RENAULT KERAX LP4812.14.15.19.27.28.31.33.38.40.42.43.44.45.46.48.49.51.52.53.55	
İmsp.Ref.	050.1000	050.100	050.100.1
DESCRIPTION	Compressor Cylinder Cover	Compressor Repair Kit	Compressor Repair Kit. (NBR SAC)





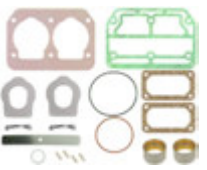

Dortrenk Turizm Gayr. Mot.Tas.San. ve Tic. Ltd.Şti.
Tax Administration & No:
 Ikitelli / 313 058 5172
Adress :
 Ikitelli O.S.B Dolapdere Sanayi Sitesi 12.Ada No:56
 Basaksehir / Istanbul / Turkiye
Tel :+90 (212) 243 02 03 Fax: +90 (212) 355 02 42
Email: bilgi@otobusyedeckparca.com

01-2017

Orj. Ref.	500 186 77 12	500 186 77 08	500 186 77 08
-----------	---------------	---------------	---------------

051.100 Ø.75		DAF 95 XF F 95 430 85CF.865AVM.1160AVM.825AVM.CKD.75CF LP4823.4830	
			
İmsp.Ref.	051.1000	051.100	051.100.2
DESCRIPTION	Compressor Cylinder Cover	Compressor Repair Kit.	Compressor Repair Kit.
Orj. Ref.			

052.100		DAF 95 XF F 95 430 95XF.CF75.CF85.CKD.F75.F95.YTZ95 1310523.1451651WABCO.9115045000.9115045010.9115045003	
			
İmsp.Ref.	052.1000	052.100	052.100.1
DESCRIPTION	Compressor Cylinder Cover	Compressor Repair Kit	Compressor Repair Kit NBR
Orj. Ref.		1331146	1331146

053.100 / 75Ø		
DAF F95.0537990 KNORR 911 504 500 2		
İmsp.Ref.	053.100	



Dortrenk Turizm Gayr. Mot.Tas.San. ve Tic. Ltd.Şti.

Tax Administration & No:

Ikitelli / 313 058 5172

Adress :

Ikitelli O.S.B Dolapdere Sanayi Sitesi 12.Ada No:56

Basaksehir / Istanbul / Turkiye

Tel :+90 (212) 243 02 03 Fax: +90 (212) 355 02 42

Email: bilgi@otobusyedekparca.com



01-2017





DESCRIPTION	Compressor Repair Kit	
Orj. Ref.		



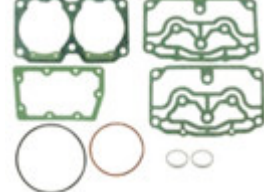
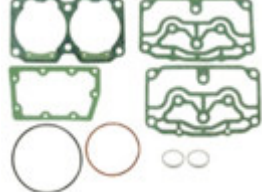

Dortrenk Turizm Gayr. Mot.Tas.San. ve Tic. Ltd.Şti.
Tax Administration & No:
 Ikitelli / 313 058 5172
Adress :
 Ikitelli O.S.B Dolapdere Sanayi Sitesi 12.Ada No:56
 Basaksehir / Istanbul / Turkiye
Tel :+90 (212) 243 02 03 Fax: +90 (212) 355 02 42
Email: bilgi@otobusyedekparca.com

01-2017

054.100		DAF 2800 – 3300 VOLVO 626060.5003460.8112426 3037344 WABCO 9115050012 / 9115050002 DAF 1317209 – 1361259 DENNIS 656960.8		
				
İmsp.Ref.	054.1000	054.100-1	054.100	054.100.2
DESCRIPTION	Comp. Cylinder Cover	Compressor Repair Kit	Compressor Repair Kit.	Compressor Repair Kit.
Orj. Ref.	911 508 804 2	1361259	1361259	1361259

055.100 75Ø		DAF 95 (9115040560 75mm TWIN) 1243571(9115040590) (9115040600)1298052 (9115038052) 1253530		
				
İmsp.Ref.	055.1000	055.100	055.100-1	067.035
DESCRIPTION	Compressor Cylinder Cover	Compressor Repair Kit .	Compressor Repair Kit	Valf Subapı
Orj. Ref.		8973344494		

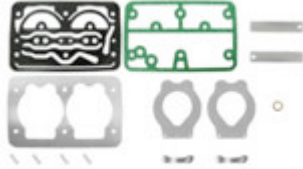
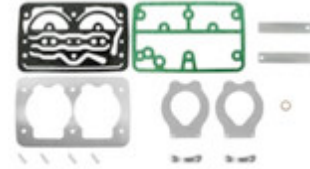
056.100 Ø.90		DAF / 85 CF . VOLVO 1320400 – FM7 / FM12 / FH12 / FH16 KNORR / LP 4969.4970.4983		
				
İmsp.Ref.	056.1000	056.1001	056.100	056.100.1
DESCRIPTION	Compressor Cylinder Cover	Valve Plate Kit	Compressor Repair Kit.	Compressor Repair Kit.
Orj. Ref.	3095839	1361262	1360612	1360612



057.100		IVECO 04850697 . 4850697 . 500320906 – 98452955 MARELLI 76615201 65808354 65808304 65808374 K 007996		
				
İmsp.Ref.	057.100	057.1000		
DESCRIPTION	Compressor Repair Kit	Compressor Cylinder Cover		





Dortrenk Turizm Gayr. Mot.Tas.San. ve Tic. Ltd.Şti.
Tax Administration & No:
Ikitelli / 313 058 5172
Adress :
Ikitelli O.S.B Dolapdere Sanayi Sitesi 12.Ada No:56
Basaksehir / Istanbul / Turkiye
Tel :+90 (212) 243 02 03 Fax: +90 (212) 355 02 42
Email: bilgi@otobusyedekparca.com

01-2017

Orj. Ref.	93161842	93161842	
Unit \$			

058.100		IVECO 98421114 . 99440236 . 98421114 – 98421116 76661601 – 79071631 .76622801766228762.76660301– 79071642 – 9316153	
			
İmsp.Ref.	058.1000	058.100	
DESCRIPTION	Plate Set	Compressor Repair Kit	
Orj. Ref.		93161598	
Unit \$			

059.100 / 80Ø			
		IVECO 790035741.99440234–99440226–98421107. 99440235 MARELLI 76622501 – 76623301	
İmsp.Ref.	059.100		
DESCRIPTION	Compressor Repair Kit		
Orj. Ref.	79071631		
Unit \$			

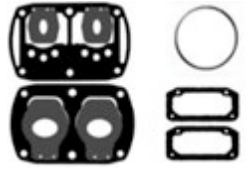
060.100		LP.4939.40.41.42.43.44.45 RVI – 5000694443.5000694444.5000696057 5000694446–5000691880– 5000694823.LP4812.4832– 5000694727. RVI 5000684744	
			
İmsp.Ref.	060.1000	060.1001	060.100
DESCRIPTION	Compressor Cylinder Cover	Compressor Cylinder Cover	Compressor Repair Kit
Orj. Ref.	5000694446	5001867696	5001867703
Unit \$			

061.100	VOLVO / BENDIX 500
----------------	---------------------------



Dortrenk Turizm Gayr. Mot.Tas.San. ve Tic. Ltd.Şti.
Tax Administration & No:
 Ikitelli / 313 058 5172
Adress :
 Ikitelli O.S.B Dolapdere Sanayi Sitesi 12.Ada No:56
 Basaksehir / Istanbul / Turkiye
Tel :+90 (212) 243 02 03 Fax: +90 (212) 355 02 42
Email: bilgi@otobusyedekparca.com

01-2017

İmsp.Ref. 061.100	061.100-1	061.1002	061.1001
DESCRIPTION Compressor Repair Kit	Compressor Repair Kit	Compressor Cylinder Cover	Valve Plate Kit
Orj. Ref.	3090471	3090472	3090473
Unit \$			

062.100		VOLVO 272 813 BENDX TUFLO 500 FL7 / F10 / F12 / FL10
İmsp.Ref. 062.100		
DESCRIPTION Compressor Repair Kit		
Orj. Ref.		
Unit \$		

063.100 / 70Ø		IVECO 99440234 IVECO 99440226 IVECO 98421107 99440235 MARELLI 76622501 . 76623301 – 76637801
İmsp.Ref. 063.100		
DESCRIPTION Compressor Repair Kit		
Orj. Ref. 79072946		
Unit \$		

064.100	VOLVO 5003336 LP.4812.13 . F16/FL10/FL6/B12	
İmsp.Ref. 064.1000	064.100	064.100.1
DESCRIPTION Compressor Cylinder Cover	Compressor Repair Kit	Compressor Repair Kit
Orj. Ref. 1698158	1315376	1315376
Unit \$		

065.100		
VOLVO 8150407.8112427. LP.4825.4829		
İmsp.Ref. 065.100		



Dortrenk Turizm Gayr. Mot.Tas.San. ve Tic. Ltd.Şti.

Tax Administration & No:

Ikitelli / 313 058 5172

Adress :

Ikitelli O.S.B Dolapdere Sanayi Sitesi 12.Ada No:56

Basaksehir / Istanbul / Turkiye

Tel :+90 (212) 243 02 03 Fax: +90 (212) 355 02 42

Email: bilgi@otobusyedekparca.com

01-2017

DESCRIPTION	Compressor Repair Kit	
Orj. Ref.	3091739	
Unit \$		



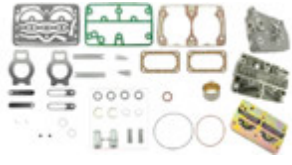
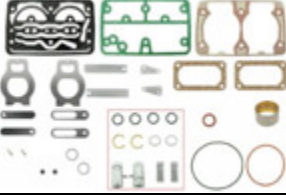
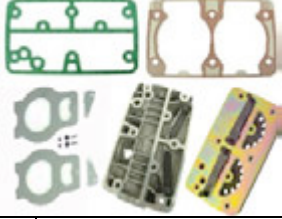
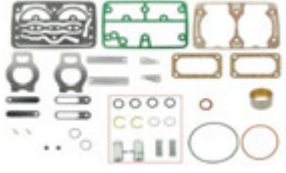

Dortrenk Turizm Gayr. Mot.Tas.San. ve Tic. Ltd.Şti.
Tax Administration & No:
 Ikitelli / 313 058 5172
Address :
 Ikitelli O.S.B Dolapdere Sanayi Sitesi 12.Ada No:56
 Basaksehir / Istanbul / Turkiye
Tel :+90 (212) 243 02 03 Fax: +90 (212) 355 02 42
Email: bilgi@otobusyedekparca.com

01-2017

066.100		SCANIA LP.4957.II177395. VOLVO LP.4934.4967.II33164.II11992DAF. 911 504 05 20 / KNORR BREMSE LK.4918.492.DAF 95 .310/350 CV	
			
İmsp.Ref.	066-1000	066.100-1	066.100
DESCRIPTION	Compressor Cylinder Cover	Compressor Repair Kit	Compressor Repair Kit.
Orj. Ref.	3097146		3097143
Unit \$			
			
İmsp.Ref.	066.1001	066.100.2	
DESCRIPTION	Compressor Plate	Compressor Repair Kit (Valve)	
Orj. Ref.			

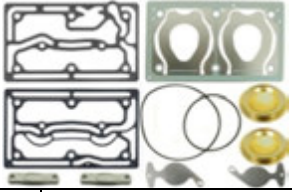
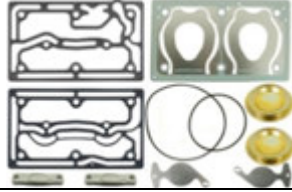
067.100		IVECO/ EURO TRAKKER /EURO CARGO 150E/ EUROTECH MT180	
			
			
İmsp.Ref.	067.100	067.100.1	067.035
DESCRIPTION	Compressor Repair Kit	Compressor Repair Kit	Valve
Orj. Ref.	4860565	4860565	
Unit \$			

068.100		RENAULT PREMIUM 440.EURO 4.20774360 VOLVO FH12 / FH13 / FH16 / FM9 / FM11 / FM13 / B13R	
			
			
İmsp.Ref.	068.100	068.100-1	068.1000
DESCRIPTION	Compressor Repair Kit	Compressor Repair Kit Nbr	Compressor Plate
Orj. Ref.	9125109212	9125109212	742141
Unit \$			



Dortrenk Turizm Gayr. Mot.Tas.San. ve Tic. Ltd.Şti.
Tax Administration & No:
 İkitelli / 313 058 5172
Adress :
 İkitelli O.S.B Dolapdere Sanayi Sitesi 12.Ada No:56
 Basaksehir / İstanbul / Türkiye
Tel :+90 (212) 243 02 03 Fax: +90 (212) 355 02 42
Email: bilgi@otobusyedekparca.com

01-2017

069.100		VOLVO FH12 / FL12 / BMC / FORD CARGO 3227	
İmsp.Ref.	069.1000	069.100	069.100-1
DESCRIPTION	Compressor Cylinder Cover	Compressor Repair Kit	Compressor Repair Kit
Orj. Ref.			
Unit \$			

070.100		VOLVO FH12/FL12 / LK 3986 / LK 3810.13.19	
İmsp.Ref.	070.1000	070.1001	070.100
DESCRIPTION	Compressor Cylinder Cover	Valve Plate Kit	Compressor Repair Kit
Orj. Ref.			
Unit \$			

071.100 Ø.85		COMMINS ISX/L/L/M/ISC/B 9111530040.9111539380.911153525.111536070.9111535430. 9111535380.	
İmsp.Ref.	071.1000	071.100	071.100.1
DESCRIPTION	Compressor Cylinder Cover	Compressor Repair Kit	Compressor Repair Kit
Orj. Ref.			
Unit \$			



Dortrenk Turizm Gayr. Mot.Tas.San. ve Tic. Ltd.Şti.
Tax Administration & No:
 İkitelli / 313 058 5172
Address :
 İkitelli O.S.B Dolapdere Sanayi Sitesi 12.Ada No:56
 Basaksehir / İstanbul / Türkiye
Tel :+90 (212) 243 02 03 Fax: +90 (212) 355 02 42
Email: bilgi@otobusyedeckparca.com

01-2017

072.100		IVECO STRALIS / EUROTECH / EUROSTAR 504033988	
İmsp.Ref.	072.100	072.100-1	
DESCRIPTION	Compressor Repair Kit	Compressor Repair Kit Nbr	
Orj. Ref.	425 49 151		
Unit \$			

073.100		STRALIS / IVECO		
İmsp.Ref.	073.1000	073.100	073.100.1	073.100.2
DESCRIPTION	Compressor Cylinder Cover	Compressor Repair Kit	Compressor Repair Kit	Compressor Repair Kit
Orj. Ref.				
Unit \$				

074.100		KAMAZ
İmsp.Ref.	074.100	
DESCRIPTION	Compressor Repair Kit	
Orj. Ref.		
Unit \$		

075.100		VOLVO.FH 12 – FM 12 – NH 12	
İmsp.Ref.	075.1000	075.100	075.100.1
DESCRIPTION	Compressor Cylinder Cover	Compressor Repair Kit	Compressor Repair Kit
Orj. Ref.		4127040010	4127040010
Unit \$			



Dortrenk Turizm Gayr. Mot.Tas.San. ve Tic. Ltd.Şti.
Tax Administration & No:
 Ikitelli / 313 058 5172
Adress :
 Ikitelli O.S.B Dolapdere Sanayi Sitesi 12.Ada No:56
 Basaksehir / Istanbul / Turkiye
Tel :+90 (212) 243 02 03 Fax: +90 (212) 355 02 42
Email: bilgi@otobusyedekparca.com

01-2017

076.100		912 112 00 00 / VOLVO FH 12	
İmsp.Ref.	076.100	076.100-1 / Nbr	076.1000
DESCRIPTION	Compressor Repair Kit	Compressor Repair Kit	Compressor Cover
Orj. Ref.	85102273	412 352 00 32	412 352 92 12
Unit \$			

077.100		DAF CF. RENAULT PREMIUM PR 4X2 KERAX MAGNUM E.TECH 400/440/480	
İmsp.Ref.	077.1000	077.100	077.100-1 / Nbr
DESCRIPTION	Compressor Cylinder Cover	Compressor Repair Kit	Compressor Repair Kit
Orj. Ref.		412 44 20 00	412 44 20 00
Unit \$			

078.100		IVECO.EUROCARGO /ACX 69A.AS.CX.D.DX	
İmsp.Ref.	078.1001	078.100	
DESCRIPTION	Compressor Plate	Compressor Repair Kit	
Orj. Ref.	93161969	4863994	
Unit \$			

079.100		VOLVO.WABCO 4571305015.4571303815	
İmsp.Ref.	079.100	079.100-1 / Nbr	



Dortrenk Turizm Gayr. Mot.Tas.San. ve Tic. Ltd.Şti.
Tax Administration & No:
 Ikitelli / 313 058 5172
Adress :
 Ikitelli O.S.B Dolapdere Sanayi Sitesi 12.Ada No:56
 Basaksehir / Istanbul / Turkiye
Tel :+90 (212) 243 02 03 Fax: +90 (212) 355 02 42
Email: bilgi@otobusyedekparca.com

01-2017

DESCRIPTION	Compressor Repair Kit	Compressor Repair Kit	
Orj. Ref.	4127040070	4127040150	
Unit \$			

080.100		JOHN DEERE RE528181.528960.528961 CATERPILLAR 10R.2767.2768.226.9579.226.9580.257.9346 ENGINE C11.C13.C15.C18ACERT	
İmsp.Ref.	080.1000	080.100	080.100.1
DESCRIPTION	Valve Plate Kit	Compressor Repair Kit	Compressor Repair Kit
Orj. Ref.		50136389	50136389
Unit \$			

081.100 Ø.85		DAF XF 95/460 XF 105 CF 912 518 920 2 – 9125100000 . 9125180030 – 9125180000 – 9125180020 9125180040.9125180010. 1674920 RK01.566	
İmsp.Ref.	081.1000		081.022
DESCRIPTION	Comp. Cylinder Cover	Compressor Cover	Valve Plate Kit
Orj. Ref.	161210		
Unit \$			
İmsp.Ref.	081.100	081.100.1	
DESCRIPTION	Compressor Repair Kit	Compressor Repair Kit	
Orj. Ref.	1622355	1622355	
Unit \$			

082.100		For Mercedes.Benz COMPRESSOR . EVO BUS. VOITH LP.700
İmsp.Ref.	082.100.1	



Dortrenk Turizm Gayr. Mot.Tas.San. ve Tic. Ltd.Şti.
Tax Administration & No:
 Ikitelli / 313 058 5172
Adress :
 Ikitelli O.S.B Dolapdere Sanayi Sitesi 12.Ada No:56
 Basaksehir / Istanbul / Turkiye
Tel :+90 (212) 243 02 03 Fax: +90 (212) 355 02 42
Email: bilgi@otobusyedekparca.com

01-2017

DESCRIPTION	Compressor Repair Kit	
Orj. Ref.	457 130 40 15	

083.100		
For Mercedes.Benz For Wabco / Evo Bus 457 130 50 15 . 457 130 38 15		
İmsp.Ref.	083.100-1	
DESCRIPTION	Compressor Repair Kit	
Orj. Ref.	457 130 50 15	

084.100		COMMINS 6BTAA.5.9 / 6CTAA.8.3 VOLKSWAGEN TRUCK	
İmsp.Ref.	084.1000	084.100-1 / Nbr	
DESCRIPTION	Compressor Cylinder Cover	Compressor Repair Kit	
Orj. Ref.		91.21250000	

085.100		AXOR OM.457 EURO 4 TRAVEGO 906 130 25 15 / 926 CITARO	
İmsp.Ref.	085.100	085.100.1	085.1000
DESCRIPTION	Compressor Repair Kit	Compressor Repair Kit	Compressor Cover Kit
Orj. Ref.			912 510 922 2

086.100		912 112 00 00 / VOLVO FH 12	
İmsp.Ref.	086.100	086.100.1	
DESCRIPTION	Compressor Repair Kit	Compressor Repair Kit	



Dortrenk Turizm Gayr. Mot.Tas.San. ve Tic. Ltd.Şti.

Tax Administration & No:

Ikitelli / 313 058 5172

Adress :

Ikitelli O.S.B Dolapdere Sanayi Sitesi 12.Ada No:56

Basaksehir / Istanbul / Turkiye

Tel :+90 (212) 243 02 03 Fax: +90 (212) 355 02 42

Email: bilgi@otobusyedekparca.com

01-2017

Orj. Ref.



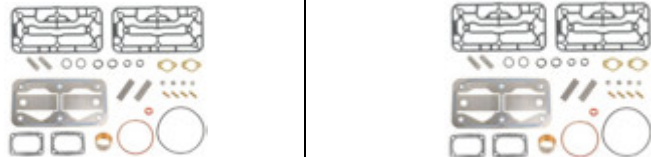

Dortrenk Turizm Gayr. Mot.Tas.San. ve Tic. Ltd.Şti.
Tax Administration & No:
 Ikitelli / 313 058 5172
Adress :
 Ikitelli O.S.B Dolapdere Sanayi Sitesi 12.Ada No:56
 Basaksehir / Istanbul / Turkiye
Tel :+90 (212) 243 02 03 Fax: +90 (212) 355 02 42
Email: bilgi@otobusyedekparca.com

01-2017

087.100		SCANIA.KNORR BREMSE LK4930 N944 SERIES BUS 720 cc LK4944 COBRA EURO 5	
			
İmsp.Ref.	087.1000	087.100	087.100.1
DESCRIPTION	Compressor Cylinder Cover	Compressor Repair Kit	Compressor Repair Kit
Orj. Ref.	1537794		
Unit \$			

088.100 / 75Ø		MAN /12.153 / 51.54101.7185 WABCO 4111450510
		
İmsp.Ref.	088.100	
DESCRIPTION	Compressor Repair Kit	
Orj. Ref.	51541017185	

089.100		BMC 9P901851 KZ1119 PRO 620
		
İmsp.Ref.	089.100	
DESCRIPTION	Compressor Repair Kit	
Orj. Ref.		
Unit \$		

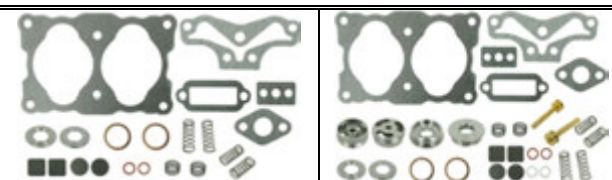
090-100		COMMINS	
			
İmsp.Ref.	090.1000	090.1007	090.100
DESCRIPTION	Compressor Cylinder Cover	Grankshaft	Compressor Repair Kit
Orj. Ref.	868043706748		
Unit \$			



Dortrenk Turizm Gayr. Mot.Tas.San. ve Tic. Ltd.Şti.
Tax Administration & No:
Ikitelli / 313 058 5172
Adress :
Ikitelli O.S.B Dolapdere Sanayi Sitesi 12.Ada No:56
Basaksehir / Istanbul / Turkiye
Tel :+90 (212) 243 02 03 Fax: +90 (212) 355 02 42
Email: bilgi@otobusyedekparca.com

01-2017

091.100		
IVECO TURBO STAR 160.30 / PEGASO 391 1229 / 9115065000		
İmsp.Ref.	091.100	
DESCRIPTION	Compressor Repair Kit	
Orj. Ref.	93162059	
Unit \$		

092.100	VOLVO FH / 16 . 20569251 / WABCO 9125120010	
İmsp.Ref.	092.100	092.100-1
DESCRIPTION	Compressor Repair Kit	Compressor Repair Kit
Orj. Ref.		
Unit \$		



093.100	MAZ	
İmsp.Ref.		093.100
DESCRIPTION		Compressor Repair Kit
Orj. Ref.		
Unit \$		

094.100	BENDIX KZ 119 PERKINS	
İmsp.Ref.		094.100
DESCRIPTION		Compressor Repair Kit
Orj. Ref.		
Unit \$		



Dortrenk Turizm Gayr. Mot.Tas.San. ve Tic. Ltd.Şti.
Tax Administration & No:
 Ikitelli / 313 058 5172
Address :
 Ikitelli O.S.B Dolapdere Sanayi Sitesi 12.Ada No:56
 Basaksehir / Istanbul / Turkiye
Tel :+90 (212) 243 02 03 Fax: +90 (212) 355 02 42
Email: bilgi@otobusyedekparca.com

01-2017

095.100		COMMINS	
			
İmsp.Ref.	095.1000	095.100	095.100.1
DESCRIPTION	Compressor Cylinder Cover	Compressor Repair Kit	Compressor Repair Kit
Orj. Ref.			
Unit \$			

096.100		
For Mercedes Benz		
İmsp.Ref.	096-100	
DESCRIPTION	Compressor Repair Kit	
Orj. Ref.		
Unit \$		

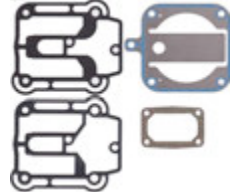
097.100		
For Mercedes Benz OM 472		
İmsp.Ref.	097.100-1	
DESCRIPTION	Compressor Repair Kit	
Orj. Ref.		
Unit \$		

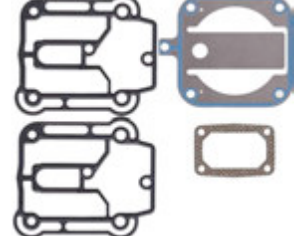
098.100		
For Mercedes Benz OM 472		
İmsp.Ref.	098.100-1	
DESCRIPTION	Compressor Repair Kit	
Orj. Ref.		
Unit \$		

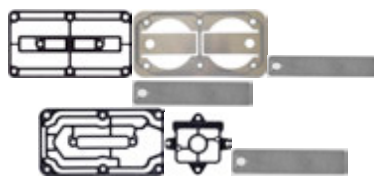
099.100		
SCANIA 1767157 LK.4948 KNORR.BREMS		
İmsp.Ref.	099.100-1	
DESCRIPTION	Compressor Repair Kit	
Orj. Ref.		
Unit \$		



Dortrenk Turizm Gayr. Mot.Tas.San. ve Tic. Ltd.Şti.
Tax Administration & No:
 Ikitelli / 313 058 5172
Address :
 Ikitelli O.S.B Dolapdere Sanayi Sitesi 12.Ada No:56
 Basaksehir / Istanbul / Turkiye
Tel :+90 (212) 243 02 03 Fax: +90 (212) 355 02 42
Email: bilgi@otobusedekparca.com

01-2017

100.100		
For Mercedes.Benz EURO 6 471.472 4711300515		
İmsp.Ref.	100.100-1	
DESCRIPTION	Compressor Repair Kit	
Orj. Ref.		
Unit \$	100,00	

101.100		
IVECO LK 3994 4897301 . 504016818 TECTOR		
İmsp.Ref.	101-100	
DESCRIPTION	Compressor Repair Kit	
Orj. Ref.		

102.100		For Mercedes.Benz Euro 3 TRAVEGO / CITARO BUS001 131 35 15 . 001 130 15 15		
İmsp.Ref.	102.1000	102.100	102.100.1	029.1008
DESCRIPTION	Compressor Cylinder Cover	Compressor Repair Kit	Compressor Repair Kit NBR	Compressor Flange
Orj. Ref.	000 130 55 19	001 130 15 15	001 130 35 15	000 131 29 32

103.100				
İmsp.Ref.	103.1000	103.1001	103.1002	103.100
DESCRIPTION	Compressor Cylinder Cover	Valve Plate Kit	Compressor Cover	Compressor Repair Kit
Orj. Ref.				



Dortrenk Turizm Gayr. Mot.Tas.San. ve Tic. Ltd.Şti.
Tax Administration & No:
 Ikitelli / 313 058 5172
Address :
 Ikitelli O.S.B Dolapdere Sanayi Sitesi 12.Ada No:56
 Basaksehir / Istanbul / Turkiye
Tel :+90 (212) 243 02 03 Fax: +90 (212) 355 02 42
Email: bilgi@otobusyedekparca.com

01-2017

104.100		
SCANIA 1308706 BENDIX		
İmsp.Ref.	099.100-1	
DESCRIPTION	Compressor Repair Kit	
Orj. Ref.		
Unit \$		

111.100		
İmsp.Ref.	111.100	
DESCRIPTION	Compressor Repair Kit	
Orj. Ref.		

112.100		IVECO	
İmsp.Ref.	112.100	112.1000	
DESCRIPTION	Compressor Repair Kit	Compressor Cover Kit	

113.100		TRAVEGO / ACTROS 502 LA	
İmsp.Ref.	113.1000		
DESCRIPTION	Compressor Cylinder Cover		
Orj. Ref.	541 130 37 19		

114.100				
İmsp.Ref.	114.1000	114.100	114.100.1	114.1001
DESCRIPTION	Compressor Cylinder Cover	Compressor Repair Kit	Compressor Cover NBR	Cover
Orj. Ref.				



Dortrenk Turizm Gayr. Mot.Tas.San. ve Tic. Ltd.Şti.
Tax Administration & No:
 Ikitelli / 313 058 5172
Adress :
 Ikitelli O.S.B Dolapdere Sanayi Sitesi 12.Ada No:56
 Basaksehir / Istanbul / Turkiye
Tel :+90 (212) 243 02 03 Fax: +90 (212) 355 02 42
Email: bilgi@otobusyedekparca.com

01-2017

115.100			
		NECO / FORD	
İmsp.Ref.	115.100	115.101	
DESCRIPTION	Compressor Repair Kit	Compressor Repair Kit	
Orj. Ref.			

116.100		N94.4 SERIES BUS F.K.N BUS 1880194.1901246.1901247 LK.4949/51/56/61/70	
İmsp.Ref.	116.1000	116.1001	116.100
DESCRIPTION	Compressor Cylinder Cover	Valve Plate Kit	Compressor Repair Kit
Orj. Ref.			



118.100		IVECO STARLIS LK4936 – FORD CARGO 3224/3230 LP4857		
İmsp.Ref.	118.1000	118.1002	118.1001	118.100
DESCRIPTION	Compressor Cylinder Cover	Compressor Cover	Valve Plate Kit	Compressor Repair Kit
Orj. Ref.	911.503.805.2		SEB1878004	



Dortrenk Turizm Gayr. Mot.Tas.San. ve Tic. Ltd.Şti.
Tax Administration & No:
 İkitelli / 313 058 5172
Adress :
 İkitelli O.S.B Dolapdere Sanayi Sitesi 12.Ada No:56
 Basaksehir / İstanbul / Türkiye
Tel :+90 (212) 243 02 03 Fax: +90 (212) 355 02 42
Email: bilgi@otobusyedekparca.com

01-2017



119.100		51.54100.6046 / M A N TG.A / D.2066. 430 COMMONRAIL NEOPLAN BUS 2010/2011/2012		
				
İmsp.Ref.	119.1000	119.1002	119.1001	119.100
DESCRIPTION	Compressor Cylinder Cover	Compressor Cover	Valve Plate Kit	Compressor Repair Kit
Orj. Ref.	911.516.010.0			

120.100		IVECO.EUROCARGO /ACX 69A.AS.CX.D.DX		
				
İmsp.Ref.	120.1001	120.100		
DESCRIPTION	Valve Plate Kit	Compressor Repair Kit		
Orj. Ref.		4863994		





Dortrenk Turizm Gayr. Mot.Tas.San. ve Tic. Ltd.Şti.
Tax Administration & No:
Ikitelli / 313 058 5172
Adress :
Ikitelli O.S.B Dolapdere Sanayi Sitesi 12.Ada No:56
Basaksehir / Istanbul / Turkiye
Tel :+90 (212) 243 02 03 Fax: +90 (212) 355 02 42
Email: bilgi@otobusyedeckparca.com

01-2017

8000.100		Air Conditioning Compressor	
			
İmsp.Ref.	8001.100	8001-1002	
DESCRIPTION	Compressor Repair Kit.	Valve Plate Kit	
Orj. Ref.			
Unit \$			

8002-100		Air Conditioning Compressor	
			
İmsp.Ref.	8002.1002		
DESCRIPTION	Valve Plate Kit		
Orj. Ref.			
Unit \$			

FK40-100		Air Conditioning Compressor	
			
İmsp.Ref.	FK40-100		
DESCRIPTION	Compressor Repair Kit.		
Orj. Ref.			
Unit \$			

FK40-100-1		Air Conditioning Compressor	
			
İmsp.Ref.	FK40-100-1		
DESCRIPTION	Compressor Repair Kit.		
Orj. Ref.			
Unit \$			

FK50-100		Air Conditioning Compressor	
			
İmsp.Ref.	FK50-100		
DESCRIPTION	Compressor Repair Kit.		
Orj. Ref.			
Unit \$			

FK5-100			
---------	--	---	--



Dortrenk Turizm Gayr. Mot.Tas.San. ve Tic. Ltd.Şti.

Tax Administration & No:

Ikitelli / 313 058 5172

Adress :

Ikitelli O.S.B Dolapdere Sanayi Sitesi 12.Ada No:56

Basaksehir / Istanbul / Turkiye

Tel :+90 (212) 243 02 03 Fax: +90 (212) 355 02 42

Email: bilgi@otobusyedekparca.com

01-2017

Air Conditioning Compressor

İmsp.Ref.	FK5-100
DESCRIPTION	Compressor Repair Kit.
Orj. Ref.	
Unit \$	



Dortrenk Turizm Gayr. Mot.Tas.San. ve Tic. Ltd.Şti.

Tax Administration & No:

Ikitelli / 313 058 5172

Adress :

Ikitelli O.S.B Dolapdere Sanayi Sitesi 12.Ada No:56

Basaksehir / Istanbul / Turkiye

Tel :+90 (212) 243 02 03 Fax: +90 (212) 355 02 42

Email: bilgi@otobusyedekparca.com

01-2017



Dortrenk Turizm Gayr. Mot.Tas.San. ve Tic. Ltd.Şti.

Tax Administration & No:

Ikitelli / 313 058 5172

Adress :

Ikitelli O.S.B Dolapdere Sanayi Sitesi 12.Ada No:56

Basaksehir / Istanbul / Turkiye

Tel :+90 (212) 243 02 03 Fax: +90 (212) 355 02 42

Email: bilgi@otobusyedekparca.com

01-2017

GEARBOX

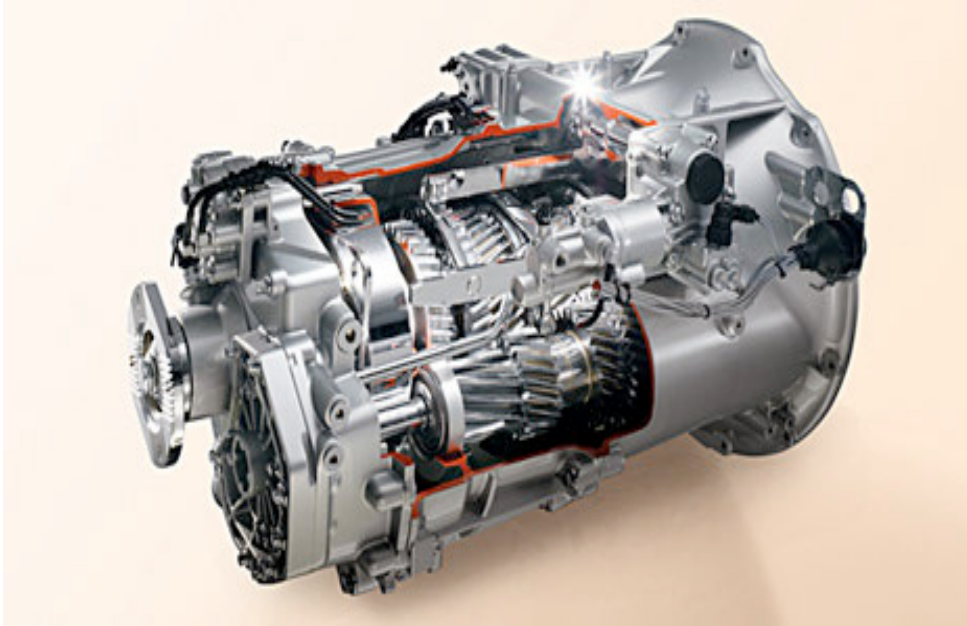









SECTION



Dortrenk Turizm Gayr. Mot.Tas.San. ve Tic. Ltd.Şti.
Tax Administration & No:
Ikitelli / 313 058 5172
Adress :
Ikitelli O.S.B Dolapdere Sanayi Sitesi 12.Ada No:56
Basaksehir / Istanbul / Turkiye
Tel :+90 (212) 243 02 03 Fax: +90 (212) 355 02 42
Email: bilgi@otobusyedeckparca.com







01-2017

PTO GASKET

			
941-116	906-0580	906-115	457-115
			
941-115	441-3080	457-1840	401-3080









Ref. No:909.100

OM 314 Gearbox Gasket set

					
909.700	909.701	914.703	914.705	914.706	914.707







Ref. No: 911.100

ZF 9.S 75 Gearbox Gasket set (2521-MERCEDES)

							
911.700	911.701	911.702	911.703	911.704	911.705	911.706	911.707

Ref. No: 913.100

GV.4.65 6 İLERİ 65 Gearbox Gasket set V/6

					
913.700	913.703	913.704	913.705	913.706	913.707



Dortrenk Turizm Gayr. Mot.Tas.San. ve Tic. Ltd.Şti.
Tax Administration & No:
 Ikitelli / 313 058 5172
Adress :
 Ikitelli O.S.B Dolapdere Sanayi Sitesi 12.Ada No:56
 Basaksehir / Istanbul / Turkiye
Tel :+90 (212) 243 02 03 Fax: +90 (212) 355 02 42
Email: bilgi@otobusyedekparca.com

01-2017

PTO GASKET

IMSP Ref.	Orj. No.	DESCRIPTION	Unit
941-116		PTO Gasket	
941-116-1		PTO Gasket (Nbr Metal)	
906-0580		PTO Gasket	
906-0580-1		PTO Gasket (Nbr Metal)	
906-115		PTO Gasket	
906-115-1		PTO Gasket (Nbr Metal)	
457-115		PTO Gasket	
457-115-1		PTO Gasket (Nbr Metal)	
941-115		PTO Gasket	
941-115-1		PTO Gasket (Nbr Metal)	
441-3080		PTO Gasket	
441-3080-1		PTO Gasket (Nbr Metal)	
457-1840		PTO Gasket	
457-1840-1		PTO Gasket (Nbr Metal)	
401-3080		PTO Gasket	
401-3080-1		PTO Gasket (Nbr Metal)	

GEARBOX		OM 314 Gearbox Gasket set	
IMSP Ref.	Orj. No.	STOK ADI	
909.100		Gearbox Gasket Set	Set.
909.700		Gasket	Pcs.
909.701		Gasket	Pcs.

GEARBOX		ZF 9.S 75 Gearbox Gasket set (2521-MERCEDES)	
IMSP Ref.	Orj. No.	DESCRIPTION	Unit
911.100		Gearbox Gasket Set	Set.
911.100.1		Gearbox Gasket Set Nbr	Set.
911.700		Gasket	Pcs.
911.701		Gasket	Pcs.
911.702		Gasket	Pcs.
911.703		Gasket	Pcs.
911.704		Gasket	Pcs.
911.705		Gasket	Pcs.
911.706	81.96601.0444	Gasket	Pcs.
911.707		Gasket	Pcs.









GEARBOX		GV.4.65 6 65 Gearbox Gasket set V/6	
IMSP Ref.	Orj. No.	DESCRIPTION	Unit
913.100		Gearbox Gasket Set	Set.
913.700		Gasket	Pcs.
913.703		Gasket	Pcs.
913.704		Gasket	Pcs.

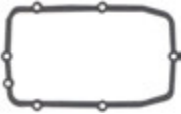



















Dortrenk Turizm Gayr. Mot.Tas.San. ve Tic. Ltd.Şti.
Tax Administration & No:
 Ikitelli / 313 058 5172
Adress :
 Ikitelli O.S.B Dolapdere Sanayi Sitesi 12.Ada No:56
 Basaksehir / Istanbul / Turkiye
Tel :+90 (212) 243 02 03 Fax: +90 (212) 355 02 42
Email: bilgi@otobusyedekparca.com





01-2017

913,705		Gasket	Pcs.	
913.706		Gasket	Pcs.	
913.707		Gasket	Pcs.	

Ref. No: 914.100		OM.302.352 GEARBOX GASKET SET					
							
914.700	914.701	914.703	914.704	914.705	914.706	914.707	914.708

Ref. No: 915.100		ZF 6.S . 65 GEARBOX GASKET SET					
							
915.700	916.701		916.702		916.703		
							
916.704	916.705	916.706	916.707	916.708			

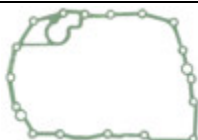
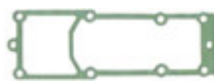
Ref. No:916.100		ZF 6.S 80.90 GEARBOX GASKET SET V/8				
						
916.700	916.701	916.702	916.703	916.704		
						
916.705	916.706	916.707	916.708			

Ref. No:917.100		ZF.9.S.16.S 109 GEARBOX GASKET SET				
						
917.700	917.701	917.702	917.703	911.703		



Dortrenk Turizm Gayr. Mot.Tas.San. ve Tic. Ltd.Şti.

Tax Administration & No:

Ikitelli / 313 058 5172

Adress :









Ikitelli O.S.B Dolapdere Sanayi Sitesi 12.Ada No:56

Basaksehir / Istanbul / Turkiye

Tel :+90 (212) 243 02 03 Fax: +90 (212) 355 02 42

Email: bilgi@otobusyedekparca.com

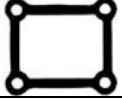
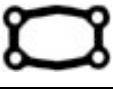
01-2017

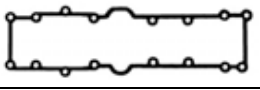
				
917.704	917.705	911.706	917.707	917.708
				
917.709	917.710	911.707	917.711	917.912



Dortrenk Turizm Gayr. Mot.Tas.San. ve Tic. Ltd.Şti.
Tax Administration & No:
 Ikitelli / 313 058 5172
Adress :
 Ikitelli O.S.B Dolapdere Sanayi Sitesi 12.Ada No:56
 Basaksehir / Istanbul / Turkiye
Tel :+90 (212) 243 02 03 Fax: +90 (212) 355 02 42
Email: bilgi@otobusyedekparca.com

01-2017

GEARBOX		GEARBOX GASKET SET OM 302.360.352		
STOK NO	Orj. No.	DESCRIPTION	Unit	
914.100		Gearbox Set Gasket	Set.	
914.700		Cover Gasket	Pcs.	
914.701		Gasket	Pcs.	
914.703		Power Point Pole Gasket	Pcs.	
914.704		Gasket	Pcs.	
914.705		Gasket	Pcs.	
914.706		Gasket	Pcs.	
914.707		Gasket	Pcs.	
914.708		Gasket	Pcs.	

GEARBOX		GEARBOX GASKET SET ZF 6.S.65		
STOK NO	Orj. No.	DESCRIPTION	Unit	
915.100		Gearbox Set Gasket	Set.	
915.700		Gasket	Pcs.	
916.701		Gasket	Pcs.	
916.702		Gasket	Pcs.	
916.703		Gasket	Pcs.	
916.704		Gasket	Pcs.	
916.705		Gasket	Pcs.	
916.706		Gasket	Pcs.	
916.707		Gasket	Pcs.	
916.708		Gasket	Set.	

GEARBOX		GEARBOX GASKET SET V/8 ZF 6.S 80.90		
STOK NO	Orj. No.	DESCRIPTION	Unit	
916.100		Gearbox Set Gasket	Set.	
916.700		Gasket	Pcs.	
916.701		Gasket	Pcs.	
916.702		Gasket	Pcs.	
916.703		Gasket	Pcs.	
916.704		Gasket	Pcs.	
916.705		Gasket	Pcs.	
916.706		Gasket	Pcs.	
916.707		Gasket	Pcs.	
916.708		Gasket	Pcs.	

GEARBOX		GEARBOX GASKET SET ZF.9.S.16.S 109 / 180		
STOK NO	Orj. No.	DESCRIPTION	Unit	
917.100		Gearbox Set Gasket	Set.	
917.700		Cover Gasket	Pcs.	
917.701		Gasket	Pcs.	
917.702		Gasket	Pcs.	
917.703	81.96601.0492	Gasket	Pcs.	
917.704		Gasket	Pcs.	
917.705		Gasket	Pcs.	
911.706	81.9660.0444	Gasket	Pcs.	
917.707		Gasket	Pcs.	
917.708		Gasket	Pcs.	
917.709		Gasket	Pcs.	
911.703		Gasket	Pcs.	
911.707		Gasket	Pcs.	
911.711		Gasket	Pcs.	
917.912	81.32903.0263	Gearbox Tower Gasket	Pcs.	



Dortrenk Turizm Gayr. Mot.Tas.San. ve Tic. Ltd.Şti.
Tax Administration & No:
 Ikitelli / 313 058 5172
Adress :
 Ikitelli O.S.B Dolapdere Sanayi Sitesi 12.Ada No:56
 Basaksehir / Istanbul / Turkiye
Tel :+90 (212) 243 02 03 Fax: +90 (212) 355 02 42
Email: bilgi@otobusyedekparca.com

01-2017

Ref. No:918.100	GEARBOX GASKET SET ZF.16.S 110				
918.700	918.701	918.702	918.703	918.704	
916.704	916.705	918.705	918.706		

Ref. No:919.100	GEARBOX GASKET SET ZF.16.S.130.160.190.220 130					
919.700	919.701	919.702	919.703	919.704		
919.705	919.706	919.707	919.708	919.709	919.710	

Ref. No:920.100	GEARBOX GASKET SET 16 K FULLER				
920.700	920.701	920.702	920.703	911.703	
920.704	920.705	920.706	920.707	920.708	
920.709	920.710	920.711	920.712	920.713	
920.714	920.715	920.716	920.717	920.718	



Dortrenk Turizm Gayr. Mot.Tas.San. ve Tic. Ltd.Şti.
Tax Administration & No:
Ikitelli / 313 058 5172
Adress :
Ikitelli O.S.B Dolapdere Sanayi Sitesi 12.Ada No:56
Basaksehir / Istanbul / Turkiye
Tel :+90 (212) 243 02 03 Fax: +90 (212) 355 02 42
Email: bilgi@otobusyedekparca.com

01-2017

GEARBOX		GEARBOX GASKET SET ZF.16.S / 110		
IMSP Ref.	Orj. Ref.	DESCRIPTION	Unit	
918.100		Gearbox Set Gasket	Set.	
918.700		Cover Gasket	Pcs.	
918.701		Gasket	Pcs.	
918.702		Gasket	Pcs.	
918.703		Gasket	Pcs.	
918.704		Gasket	Pcs.	
918.705		Gasket	Pcs.	
918.706		Gasket	Pcs.	

GEARBOX		ZF.16.S.130.160.190.220 130 GEARBOX GASKET SET		
IMSP Ref.	Orj. Ref.	DESCRIPTION	Unit	
919.100	1295298915	Gearbox Set Gasket (16S / 130)	Set.	
919.700		Cover Gasket	Pcs.	
919.701		Gasket	Pcs.	
919.702		Gasket	Pcs.	
919.703		Gasket	Pcs.	
919.704		Gasket	Pcs.	
919.705		Gasket	Pcs.	
919.706		Gasket	Pcs.	
919.707		Gasket	Pcs.	
919.708		Gasket	Pcs.	
919.709		Gasket	Pcs.	
919.710		Gasket	Pcs.	

GEARBOX		16 K FULLER GEARBOX GASKET SET		
IMSP Ref.	Orj. Ref.	DESCRIPTION	Unit	
920.100		Gearbox Set Gasket	Set.	
920.700		Cover Gasket	Pcs.	
920.701		Gasket	Pcs.	
920.702		Gasket	Pcs.	
920.703		Gasket	Pcs.	
920.704		Gasket	Pcs.	
920.705		Gasket	Pcs.	
920.706		Gasket	Pcs.	
920.707		Gasket	Pcs.	
920.708		Gasket	Pcs.	
920.709		Gasket	Pcs.	
920.710		Gasket	Pcs.	
920.711		Gasket	Pcs.	
911.703		Gasket	Pcs.	



Dortrenk Turizm Gayr. Mot.Tas.San. ve Tic. Ltd.Şti.
Tax Administration & No:
 Ikitelli / 313 058 5172
Adress :
 Ikitelli O.S.B Dolapdere Sanayi Sitesi 12.Ada No:56
 Basaksehir / Istanbul / Turkiye
Tel :+90 (212) 243 02 03 Fax: +90 (212) 355 02 42
Email: bilgi@otobusyedekparca.com

01-2017

Ref. No:921.100	STAR 155.9 – 155.16 . 180.16 . 155 GEARBOX GASKET SET					
921.700	921.701	921.702	921.703	921.704	921.705	
924.706	913.705	913.706	921.709	921.710	921.711	921.712

Ref. No: 922.100	ZF.16.S151.16.S.181.16.S.221 NEW 16.S.1620.1820.2220.2221.520.252 /151 GEARBOX GASKET SET				
922.700	922.701	922.703	911.703	922.704	
922.705	922.706	922.707	911.707	922.708	
922.709	922.710				

Ref. No:923.100	ZF . S6 85 GEARBOX GASKET SET				
923.700	923.701	923.708	923.704	911.706	
923.706	923.707	911.707	923.703	923.709	



Dortrenk Turizm Gayr. Mot.Tas.San. ve Tic. Ltd.Şti.
Tax Administration & No:
 Ikitelli / 313 058 5172
Address :
 Ikitelli O.S.B Dolapdere Sanayi Sitesi 12.Ada No:56
 Basaksehir / Istanbul / Turkiye
Tel :+90 (212) 243 02 03 Fax: +90 (212) 355 02 42
Email: bilgi@otobusyedekparca.com

01-2017

GEARBOX		STAR 155.9 – 155.16 . 180.16 155 GEARBOX GASKET SET		
IMSP Ref.	Orj. Ref.	DESCRIPTION	Unit	
921.100		Gearbox Set Gasket	Set.	
921.700		Cover Gasket	Pcs.	
921.701		Gasket	Pcs.	
921.702		Gasket	Pcs.	
921.703		Gasket	Pcs.	
921.704		Gasket	Pcs.	
921.705		Gasket	Pcs.	
922.706		Gasket	Pcs.	
913.705		Gasket	Pcs.	
913.706		Gasket	Pcs.	
921.709		Gasket	Pcs.	
921.710		Gasket	Pcs.	
921.711		Gasket	Pcs.	
922.712		Gasket	Pcs.	











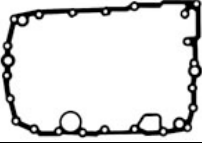
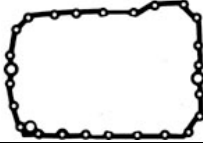

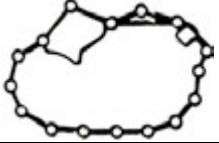
GEARBOX		ZF.16.S151.16.S.181.16.S.221 NEW 16.S.1620.1820.2220.2221.520.2521 / 151 GEARBOX GASKET SET		
922.100	1315298001	Gearbox Set Gasket (16S 151)	Set.	
922.100.1		Gearbox Set Gasket (Orj. Nbr Met. Sacli)	Pcs.	
922.700		Gasket	Pcs.	
922.701		Gasket	Pcs.	
922.703		Gasket	Pcs.	
922.704		Gasket	Pcs.	
922.704.1		Gasket (Orj. Nbr Met. Sacli)	Pcs.	
922.705		Gasket	Pcs.	
922.705.1		Gasket (Orj. Nbr Met. Sacli)	Pcs.	
922.706		Gasket	Pcs.	
922.707		Gasket	Pcs.	
922.708		Gasket	Pcs.	
922.709		Tower Gasket	Pcs.	
922.710		Gasket	Pcs.	
911.703		Gasket	Pcs.	
911.707		Gasket	Pcs.	



GEARBOX		ZF . S6 Ø85 GEARBOX GASKET SET		
923.100	131 029 8002	Gearbox Set Gasket (81.92400.6056)	Set.	
923.700	81.32120.0013	Gasket (Orj. Nbr Met. Sacli)	Pcs.	
923.701	81.32903.0256	Gasket	Pcs.	
923.703		Gasket	Pcs.	
923.704		Gasket	Pcs.	
911.706	81.96601.0444	Gasket	Pcs.	
923.706	81.96601.0604	Gasket	Pcs.	
911.707		Gasket	Pcs.	
923.707		Gasket	Pcs.	
923.708	81.96601.0442	Gasket	Pcs.	
923.709		Gasket (Nbr Sacli)	Pcs.	







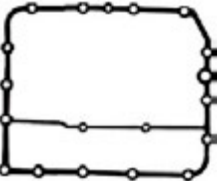
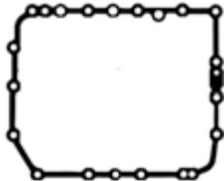
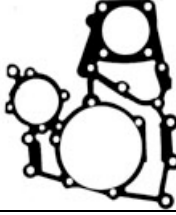
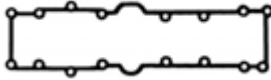



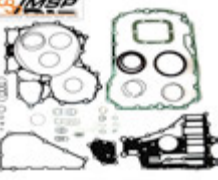

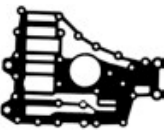



Dortrenk Turizm Gayr. Mot.Tas.San. ve Tic. Ltd.Şti.
Tax Administration & No:
 Ikitelli / 313 058 5172
Address :
 Ikitelli O.S.B Dolapdere Sanayi Sitesi 12.Ada No:56
 Basaksehir / Istanbul / Turkiye
Tel :+90 (212) 243 02 03 Fax: +90 (212) 355 02 42
Email: bilgi@otobusyedeckparca.com

01-2017

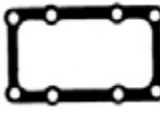
Ref. No: 925.100	ZF / 8.S.180/ 240 Ø180 GEARBOX GASKET FORTUNA				
					
922.700	922.701	925.701	925.702	922.703	
					
911.703	922.704	922.705	922.706	922.707	
					
911.707	922.708	922.709	925.711	925.703	

926.100	180Ø FORTUNA GEARBOX COVER GASKET				
					
926.700	926.702	926.701	917.912	926.704	

MAN – MERCEDES RETARDER GEARBOX COVER GASKET						
						
927.100	927.700	927.701	927.702	927.706	927.703	927.704

Ref. No:928.100	6.S 36.6.S.850 12.153 GEARBOX SET GASKET				
					
928.700	928.701	928.702	911.703	928.703	
					



Dortrenk Turizm Gayr. Mot.Tas.San. ve Tic. Ltd.Şti.

Tax Administration & No:

Ikitelli / 313 058 5172

Adress :

Ikitelli O.S.B Dolapdere Sanayi Sitesi 12.Ada No:56

Basaksehir / Istanbul / Turkiye

Tel :+90 (212) 243 02 03 Fax: +90 (212) 355 02 42

Email: bilgi@otobusyedekparca.com

01-2017

928.704

928.705

911.706

928.706



Dortrenk Turizm Gayr. Mot.Tas.San. ve Tic. Ltd.Şti.
Tax Administration & No:
 Ikitelli / 313 058 5172
Address :
 Ikitelli O.S.B Dolapdere Sanayi Sitesi 12.Ada No:56
 Basaksehir / Istanbul / Turkiye
Tel :+90 (212) 243 02 03 Fax: +90 (212) 355 02 42
Email: bilgi@otobusyedekparca.com

01-2017

ZF.1315.298.001		GEARBOX GASKET FORTUNA ZF – 8.S.180/240. Ø180		
IMSP Ref.	ORJ. Ref.	DESCRIPTION	Unit	
925.100		Gearbox Set Gasket	Set.	
925.100.1		Gearbox Set Gasket (Orj. Nbr Met. Saclı)	Pcs.	
922.704		Gasket	Pcs.	
922.704.1		Gasket (Orj. Nbr Met. Saclı)	Pcs.	
922.705		Gasket	Pcs.	
922.705.1		Gasket (Orj. Nbr Met. Saclı)	Pcs.	
922.706		Gasket	Pcs.	
922.707		Gasket	Pcs.	
922.708		Gasket	Pcs.	
922.709		Tower Gasket	Pcs.	
922.710		Gasket	Pcs.	
911.703		Gasket	Pcs.	
911.707		Gasket	Pcs.	
925.701		Gasket	Pcs.	
925.702		Gasket	Pcs.	
925.703		Devil Axle Cover Gasket	Pcs.	
922.703.1		Gasket (Orj. Nbr Met. Saclı)	Pcs.	
925.711		Gearbox Gasket	Pcs.	

GEARBOX GASKET Ø180 FORTUNA				
IMSP Ref.	ORJ. Ref.	DESCRIPTION	Unit	
926.700		Automatic Gearbox Brain Cover Gasket	Set.	
926.701		Automatic Gearbox Brain Cover Gasket	Pcs.	
926.702	81 32903.0252	Gearbox Tower Gasket	Pcs.	
926.703	81.32903.0263	Gasket	Pcs.	
917.912		Gearbox Tower Gasket	Pcs.	



MAN.MERCEDES RETARDER GEARBOX COVER GASKET				
IMSP Ref.	ORJ. Ref.	DESCRIPTION	Unit	
927.100.1		Gearbox Set Gasket (Orj. Nbr Met. Saclı)	Set.	
927.700	81 552010004	Retarder Gearbox Cover Gasket (Orj. Nbr Met.Saclı)	Pcs.	
927.701	050 131 44 34	Retarder Gearbox Gasket (Orj. Nbr Met. Saclı)	Pcs.	
927.702		Tower Gasket	Pcs.	
927.703		Tower Gasket	Pcs.	
927.704		Tower Gasket	Pcs.	
927.706		Gasket	Pcs.	





GEARBOX SET GASKET 6 S 36 . 6.S.850 12.153				
IMSP Ref.	ORJ. Ref.	DESCRIPTION	Unit	
928.100		Gearbox Set Gasket	Set.	
928.700		Gasket	Pcs.	
928.701		Gasket Orj. (Nbr Met.)	Pcs.	
928.702		Gasket	Pcs.	
928.703		Gasket	Pcs.	
928.704		Gasket	Pcs.	
928.706		Gasket	Pcs.	
911.706	581.96601.0444	Gasket	Pcs.	
911.703		Gasket	Pcs.	



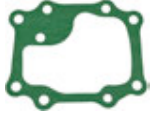

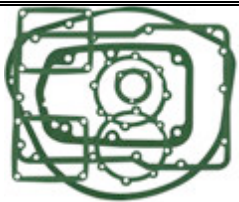

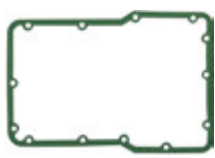
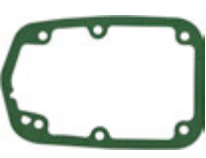
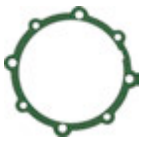







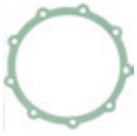

Dortrenk Turizm Gayr. Mot.Tas.San. ve Tic. Ltd.Şti.
Tax Administration & No:
Ikitelli / 313 058 5172
Adress :
Ikitelli O.S.B Dolapdere Sanayi Sitesi 12.Ada No:56
Basaksehir / Istanbul / Turkiye
Tel :+90 (212) 243 02 03 Fax: +90 (212) 355 02 42
Email: bilgi@otobusyedekparca.com

01-2017

Ref. No: 929.100	GEARBOX SET GASKET			
				
929.100	929.701	929.702		

Ref. No: 930.100	GEARBOX SET GASKET SCANIA DS11 760.860.870.871			
				
930.100	930.700	930.701	930.702	930.703
				
930.704	930.705			

Ref. No: 933.100	GEARBOX SET GASKET			
				
933.100	933.701	933.702	933.703	933.704
				
933.705	933.706	933.707	933.708	

Ref. No: 935.100	Gearbox Gasket 12 AS ASTRONIC			
				
935.100	935.700	927.701	927.706	935.703



Dortrenk Turizm Gayr. Mot.Tas.San. ve Tic. Ltd.Şti.
Tax Administration & No:
Ikitelli / 313 058 5172
Address :
Ikitelli O.S.B Dolapdere Sanayi Sitesi 12.Ada No:56
Basaksehir / Istanbul / Turkiye
Tel :+90 (212) 243 02 03 Fax: +90 (212) 355 02 42
Email: bilgi@otobusyededekparca.com

01-2017

GEARBOX SET GASKET

IMSP Ref.	Orj. Ref.	DESCRIPTION	Unit	
929.100	81 552010004	Gearbox Cover Gasket (Orj. Nbt Met. Saclı)	Set.	
929.701	050 131 44 34	Gasket	Pcs.	
929.702		Gasket	Pcs.	

GEARBOX SET GASKET SCANIA DS11 760.860.870.871

930.100		Gearbox Set Gasket	Set.	
930.700		Gasket	Pcs.	
930.701		Gasket	Pcs.	
930.702		Gasket	Pcs.	
930.703		Gasket	Pcs.	
930.704		Gasket	Pcs.	
930.705		Gasket	Pcs.	

GEARBOX SET GASKET SCANIA DS11 GR.900.GRS.900

931.100		Gearbox Set Gasket	Set.	
931.700		Gasket	Pcs.	
931.701		Gasket	Pcs.	
931.702		Gasket	Pcs.	
931.703		Gasket	Pcs.	

GEARBOX SET GASKET

933.100		Gearbox Set Gasket	Set.	
933.701		Gasket	Pcs.	
933.702		Gasket	Pcs.	
933.703		Gasket	Pcs.	
933.704		Gasket	Pcs.	
933.705		Gasket	Pcs.	
933.706		Gasket	Pcs.	
933.707		Gasket	Pcs.	
933.708		Gasket	Pcs.	







Gearbox Gasket 12 AS ASTRONIC

935.100.1	6085298033	Gearbox Set Gasket	Set.	
935.700		Gearbox Gasket (Nbr)	Pcs.	
927.701		Gearbox Gasket (Nbr)	Pcs.	
927.706		Gearbox Gasket (Nbr)	Pcs.	
935.703		Gearbox Gasket (Nbr)	Pcs.	

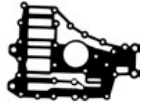
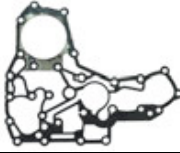



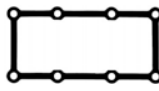

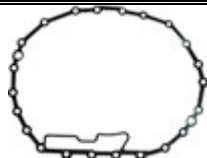
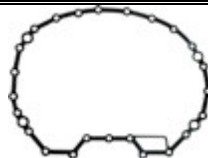

Dortrenk Turizm Gayr. Mot.Tas.San. ve Tic. Ltd.Şti.
Tax Administration & No:
 Ikitelli / 313 058 5172
Adress :
 Ikitelli O.S.B Dolapdere Sanayi Sitesi 12.Ada No:56
 Basaksehir / Istanbul / Turkiye
Tel :+90 (212) 243 02 03 Fax: +90 (212) 355 02 42
Email: bilgi@otobusyedekparca.com

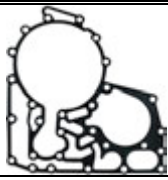
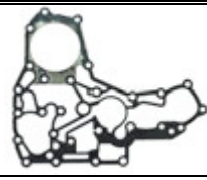
01-2017

Ref. No: 940.100	GEARBOX GASKET SET 6 S 1901				
					
940.700	927.701	943.702	923.708	927.706	
					
940.702	923.703	923.701	911.707	926.704	

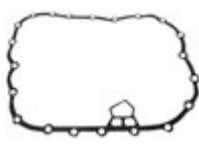
Ref. No: 942.100	Gearbox Gasket 12 AS 2330	
		
942.700	942.701	

Ref. No: 943.100	GEARBOX GASKET G/R			
				
943.100	943.701	943.702	940.701	

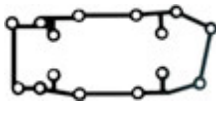
Ref. No: 945.100	Gearbox Gasket set 16 S 2031.2031.2033.2220.2331.2333 1325.298.009.ZF					
						
933.100	945.700	945.702	945.703	945.706	945.705	945.704



Dortrenk Turizm Gayr. Mot.Tas.San. ve Tic. Ltd.Şti.
Tax Administration & No:
Ikitelli / 313 058 5172
Adress :
Ikitelli O.S.B Dolapdere Sanayi Sitesi 12.Ada No:56
Basaksehir / Istanbul / Turkiye
Tel :+90 (212) 243 02 03 Fax: +90 (212) 355 02 42
Email: bilgi@otobusyedeckparca.com

01-2017

940.100	Gearbox Gasket 6 S 1901		
IMSP Ref.	STOK ADI		Unit
940.700	81329030264	Gearbox Gasket	Set.
943.702		Gearbox Gasket	Pcs.
923.708		Gearbox Gasket	Pcs.
911.707		Gearbox Gasket	Pcs.
923.701		Gearbox Gasket	Pcs.
923.703		Gearbox Gasket	Pcs.
926.704		Gearbox Gasket	Pcs.
927.701		Gearbox Gasket	Pcs.
927.706		Gearbox Gasket	Pcs.

942.100	Gearbox Gasket 12 AS 2330.2130.2331 TGA.TGX		
IMSP Ref.	STOK ADI		Unit
942.700	81329030281	Gearbox Gasket	Set.
942.701	81329030282	Gearbox Gasket	Pcs.

943.100	SCAINA RETARDER G/R GEARBOX 16 S 2031.2031.2033.2220.2331.2333		
IMSP Ref.	STOK ADI		Unit
943.701	1491103	Gearbox Gasket	Set.
943.702	1799371	Gearbox Gasket	Pcs.
940.701	1766023	Gearbox Gasket	Pcs.

945.100	Gearbox Gasket set 16 S 2031.2031.2033.2220.2331.2333 1325.298.009.ZF		
IMSP Ref.	STOK ADI		Unit
933.100		Gearbox Gasket Set	Set.
945.700		Gearbox Gasket	Pcs.
945.702		Gearbox Gasket	Pcs.
945.703		Gearbox Gasket	Pcs.
945.704		Gearbox Gasket	Pcs.
945.705		Gearbox Gasket	Pcs.
945.706		Gearbox Gasket	Pcs.



Dortrenk Turizm Gayr. Mot.Tas.San. ve Tic. Ltd.Şti.

Tax Administration & No:

Ikitelli / 313 058 5172

Adress :

Ikitelli O.S.B Dolapdere Sanayi Sitesi 12.Ada No:56

Basaksehir / Istanbul / Turkiye

Tel :+90 (212) 243 02 03 Fax: +90 (212) 355 02 42

Email: bilgi@otobusyedekparca.com

01-2017



Dortrenk Turizm Gayr. Mot.Tas.San. ve Tic. Ltd.Şti.

Tax Administration & No:

Ikitelli / 313 058 5172

Adress :

Ikitelli O.S.B Dolapdere Sanayi Sitesi 12.Ada No:56

Basaksehir / Istanbul / Turkiye

Tel :+90 (212) 243 02 03 Fax: +90 (212) 355 02 42

Email: bilgi@otobusyedekparca.com

01-2017

RETARDER

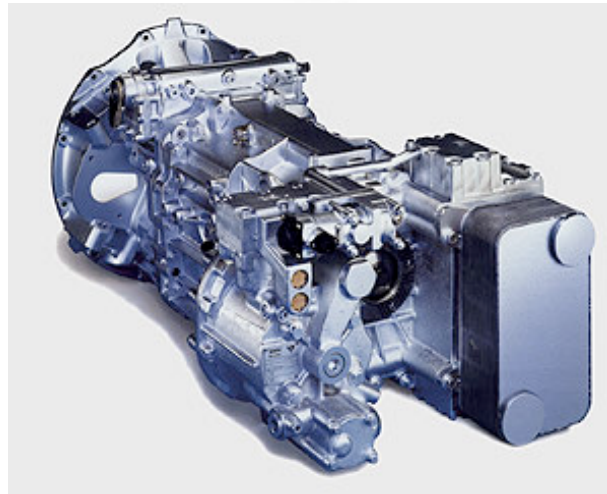

SECTION



Dortrenk Turizm Gayr. Mot.Tas.San. ve Tic. Ltd.Şti.
Tax Administration & No:
 Ikitelli / 313 058 5172
Address :
 Ikitelli O.S.B Dolapdere Sanayi Sitesi 12.Ada No:56
 Basaksehir / Istanbul / Turkiye
Tel :+90 (212) 243 02 03 Fax: +90 (212) 355 02 42
Email: bilgi@otobusyedekparca.com

01-2017

RETARDER REPAIR KIT H115/403 TRAVEGO

İmsp.Ref.	H115.100	H115.101		H115.102	
Description	Retarder Full Set	Retarder Half Set		O-ring Full Set	
Orj. Ref.	67652620	67353650		67 5561 10	
İmsp.Ref.	53.0104.10	H115.163	H115.9025	H115.300	70-31414-20
Description	Segment	Y/M Felt	Ball Tip Nut	Liquid Gasket	Liquid Gasket 200ml
Orj. Ref.		67 1485 10-11			
İmsp.Ref.	H115.302	H115.301	H115.303	H115.304	H115.160
Description	Thin Felt	Steel Felt	Buoy Felt	Throat Felt	Felt O-ring
Orj. Ref.	90 8607 20	90 8608 20	90 7277 10	023 997 8847	01 0042 40
	Yeni Model		Eski Model		Küçük Boy
İmsp.Ref.	H115.8210	H115.2240	H115.8110	H115.8620	H115.162
Description	Stor O-ring	Stor O-ring	Aluminum Nut	Aluminum Nut	Fiber Segment
Orj. Ref.	153 0017 8210	67 2422 40	153 00178110	67 1486 20-21	53 0462 20
	ORJ		Native		ORJ
İmsp.Ref.	R115.260	R115.260-1	H115.250	H115.305	H115.5812
Description	Retarder Sensor	Retarder Sensor	Buoy	Buoy Repair Kit	Pressure Sensor
Orj. Ref.	000 821 0081	000 821 0081	53 1332 11-12		H53.825812



Dortrenk Turizm Gayr. Mot.Tas.San. ve Tic. Ltd.Şti.
Tax Administration & No:
 Ikitelli / 313 058 5172
Address :
 Ikitelli O.S.B Dolapdere Sanayi Sitesi 12.Ada No:56
 Basaksehir / Istanbul / Turkiye
Tel :+90 (212) 243 02 03 Fax: +90 (212) 355 02 42
Email: bilgi@otobusyedekparca.com

01-2017

For RETARDER / H 115 / 403 TRAVEGO					
İmsp.Ref.	H115.090	H115.091	H115.111	H115.110	
Description	O-ring Thick	O-ring Thin	Inner Cover O-ring (Thick)	Inner Cover O-ring (Thin)	
Orj. Ref.					
İmsp.Ref.	H115.150	H115.120	H115.130	H115.140	
Description	Boiler O-Ring Set	Boiler O-ring	Boiler O-ring	Boiler O-ring	
Orj. Ref.					
İmsp.Ref.	H115.170	H115.113	H115.112	H115.180	H115.190
Description	Buoy O-ring	Pipe O-ring Y/M	Pipe O-ring	Prop O-ring	Valve O-ring
Orj. Ref.	01 0647 56				
İmsp.Ref.	H115.6810	53-1008-10	H115. 2425	704121-5407-0	
Description	Muffler Set	Stator Injektör	Excacuation Valve	Prof Valve Repair Kit	
Orj. Ref.	53.3468.10		67 2550 2425		
İmsp.Ref.	H115.5211	H115.5211-1	H115.1810	H115.1810-1	
Description	Prof Table	Prof Table	Valve	Valve	
Orj. Ref.	53 9452 11	53 9452 11	65 1418 10	67 1418 10-1	
İmsp.Ref.	67-1171-10	H115.9020	H115.9021	H115.0020	
Description	Valve Top Y/M	Prof	Prof Repair Kit	Retarder Gear (Large)	
Orj. Ref.		53 9490 20		6292640020	



Dortrenk Turizm Gayr. Mot.Tas.San. ve Tic. Ltd.Şti.
Tax Administration & No:
 Ikitelli / 313 058 5172
Adress :
 Ikitelli O.S.B Dolapdere Sanayi Sitesi 12.Ada No:56
 Basaksehir / Istanbul / Turkiye
Tel :+90 (212) 243 02 03 Fax: +90 (212) 355 02 42
Email: bilgi@otobusyedeckparca.com

01-2017

R115 HV AXOR / ACTROS – For RETARDER

İmsp.Ref.	H457.300	H457.301	H457.302
Description	Retarder Inner Repair Kit	Steel Felt	Flat Felt
Orj. Ref.		124109	124107

R115 HV AXOR / ACTROS . For RETARDER Y/M

İmsp. Ref.	457.6101	457-6101-1		457.6102		H457.6810
Description	Diaphragm Repair Kit	Diaphragm Repair Kit Full		Prof Repair Kit		Muffler Set
Orj. Ref.	153 001 873-10					
İmsp.Ref.	H457-7512	H457.150	H457.162	H457.163	H457-7510	H457-7511
Description	Set	Boiler O-ring Set	Fiber Segment	Fiber Segment	Retarder Filter	Retarder Filter Cover
Orj. Ref.					0004350413	153 002 74 10
İmsp.Ref.	457-6105	457-51911				
Description	Gasket	Diaphragm Cover				



Dortrenk Turizm Gayr. Mot.Tas.San. ve Tic. Ltd.Şti.

Tax Administration & No:

Ikitelli / 313 058 5172

Adress :

Ikitelli O.S.B Dolapdere Sanayi Sitesi 12.Ada No:56

Basaksehir / Istanbul / Turkiye

Tel :+90 (212) 243 02 03 Fax: +90 (212) 355 02 42

Email: bilgi@otobusyedekparca.com

01-2017

Orj. Ref.



Dortrenk Turizm Gayr. Mot.Tas.San. ve Tic. Ltd.Şti.
Tax Administration & No:
 İkitelli / 313 058 5172
Address :
 İkitelli O.S.B Dolapdere Sanayi Sitesi 12.Ada No:56
 Basaksehir / İstanbul / Türkiye
Tel :+90 (212) 243 02 03 Fax: +90 (212) 355 02 42
Email: bilgi@otobusyedekparca.com

01-2017

FOR RETARDER R133 403 . R130 V8

İmsp.Ref.	R133.100	R133.102		R133.162		R133.140	
Description	Retarder Full Set	Retarder Half Set		E/M Segment		E/M Felt	
Orj. Ref.	67652620	67353650					
İmsp.Ref.	R133.180	53-1444-10		R133.163			
Description	Prof Valve Rubber	Valve Repair Kit E/M		Felt (E/M)			
Orj. Ref.				53.1015.11			

FOR RETARDER MAN FORTUNA

		FOR MAN . FORTUNA					
İmsp.Ref.	R133.100.2						
Description	Retarder Repair Kit (Narrow Felt)						
Orj. Ref.							
Fiyat							

For RETARDER SCAINA 4 SERIAL TRK/BVS

İmsp.Ref.	H124-100	124.4109		124.1235	
Description	Retarder Repair Kit	Gasket		Filter	
Orj. Ref.		124109		1381235	



Dortrenk Turizm Gayr. Mot.Tas.San. ve Tic. Ltd.Şti.

Tax Administration & No:

Ikitelli / 313 058 5172

Adress :

Ikitelli O.S.B Dolapdere Sanayi Sitesi 12.Ada No:56

Basaksehir / Istanbul / Turkiye

Tel :+90 (212) 243 02 03 Fax: +90 (212) 355 02 42

Email: bilgi@otobusyedekparca.com

01-2017



Dortrenk Turizm Gayr. Mot.Tas.San. ve Tic. Ltd.Şti.
Tax Administration & No:
 İkitelli / 313 058 5172
Adress :
 İkitelli O.S.B Dolapdere Sanayi Sitesi 12.Ada No:56
 Basaksehir / İstanbul / Türkiye
Tel :+90 (212) 243 02 03 Fax: +90 (212) 355 02 42
Email: bilgi@otobusyedekparca.com

01-2017

FOR RETARDER		FOR MAN.MERCEDES			
İmsp.Ref	H115.0184	H115.0185	H115.1380	H115.2080	
Description	Front Cover Gasket	Front Cover Gasket	Lower Cover Gasket	Retarder cover Gasket	
Orj. Ref.	000 438 0184	67.2043.11	000 438 1380	000 438 2080	
İmsp.Ref	H115.606	H115.1980	H115.603	H115.0210	
Description	Retarder Cover Gasket	Retarder Cover Gasket	Retarder Cover Gasket	Stator Lower Cover Gasket	
Orj. Ref.		000 438 1980		67.2002.10	
İmsp.Ref	H115.2180	H115.1480	401.416	H133.609	
Description	Retarder Cover Gasket	Buoy Gasket	Water Way Gasket	Boiler Set Gasket	
Orj. Ref.	000 438 2180	000 438 1480	656 997 0049		
İmsp.Ref	442.613	442.612	442.608		
Description	Retarder Cover Gasket	Retarder Cover Gasket	Retarder Cover Gasket		
Orj. Ref.					



Dortrenk Turizm Gayr. Mot.Tas.San. ve Tic. Ltd.Şti.

Tax Administration & No:

Ikitelli / 313 058 5172

Adress :

Ikitelli O.S.B Dolapdere Sanayi Sitesi 12.Ada No:56

Basaksehir / Istanbul / Turkiye

Tel :+90 (212) 243 02 03 Fax: +90 (212) 355 02 42

Email: bilgi@otobusyedekparca.com

01-2017

TIGHTENER PULLEY (WITH BEARING)



SECTION



Dortrenk Turizm Gayr. Mot.Tas.San. ve Tic. Ltd.Şti.
Tax Administration & No:
 Ikitelli / 313 058 5172
Address :
 Ikitelli O.S.B Dolapdere Sanayi Sitesi 12.Ada No:56
 Basaksehir / Istanbul / Turkiye
Tel :+90 (212) 243 02 03 Fax: +90 (212) 355 02 42
Email: bilgi@otobusyedekparca.com

01-2017

For MERCEDES.BENZ TIGHTENER PULLEY WITH BEARING

					
İmsp.Ref.	442.0033	442.0770	460.1970	457.1070	457.1170
Orj. Ref.	000 550 0033	442 200 07 70	460 200 19 70	457 200 10 70	457 200 11 70
Description	Tightener Pulley 403	Tightener Pulley 403	1840 Y/M Tightener Pulley	Tightener Pulley Y/M	TRAVEGO 9 PK
					
İmsp.Ref.	457.1315	457.1333	457.1470	457.1570	457.1933
Orj. Ref.	457 155 13 15	613 550 13 33	457 200 14 70	000 200 15 70	613 550 19 33
Description	Charge Dynamo KAS.	EURO 3 Tightener Pulley	Tightener Pulley	Tightener Pulley	EURO 3
					
İmsp.Ref.	457.1970	457.2070	457.3070	457.3170	457.3270
Orj. Ref.	457 200 19 70	457 200 20 70	457 200 30 70	457 200 31 70	457 200 32 70
Description	Tightener Pulley	EURO 3/4 Tightener Pulley	Tightener Pulley	Tightener Pulley	Tightener Pulley
					
İmsp.Ref.	457.4370	457.4270	541.1670	501.1970	501.0433
Orj. Ref.	457 200 43 70	457 200 42 70	541 200 16 70	541 200 19 70	000 550 04 33
Description	Tightener Pulley E/5	Tightener Pulley €5	Tightener Pulley	Tightener Pulley	Tightener Pulley
					
İmsp.Ref.	457.2815.1	457.2815	457.0115	460.0115	502.2533
Orj. Ref.	Dynamo Tightener Pulley	Dynamo Tightener Pulley	Dynamo Tightener Pulley		Tightener Pulley
Description	001 155 28 15	001 155 28 15	457 158 01 15	Dynamo Tightener Pulley Y/M Kamalı	000 550 16 33



Dortrenk Turizm Gayr. Mot.Tas.San. ve Tic. Ltd.Şti.
Tax Administration & No:
 Ikitelli / 313 058 5172
Address :
 Ikitelli O.S.B Dolapdere Sanayi Sitesi 12.Ada No:56
 Basaksehir / Istanbul / Turkiye
Tel :+90 (212) 243 02 03 Fax: +90 (212) 355 02 42
Email: bilgi@otobusyedekparca.com

01-2017

For MERCEDES.BENZ TIGHTENER PULLEY WITH BEARING					
					
İmsp.Ref.	904.2115	906.1715	906.1870	906.2070	906.2670
Orj. Ref.	001 155 21 15	906 155 17 15	906 200 00 70	906 200 20 70	906 200 26 70
Description	Şarj Dinamo	Tightener Pulley	Tightener Pulley	Tightener Pulley	Tightener Pulley
					
İmsp.Ref.	906.4570	366.0019	366.1015	541.0377	541.1870
Orj. Ref.	906 200 45 70	366 132 00 19	001 155 10 15	541 200 03 77	541 200 18 70
Description	Tightener Pulley	Tightener Pulley	Chare Dynamo	Tightener Pulley	Tightener Pulley
					
İmsp.Ref.	457.1570.2	403.0015	460.1333	460.2233	299.9240
Orj. Ref.	000 200 15 70		000 550 13 33	000 550 22 33	1699240
Description	Tightener Pulley	Charge Dynamo	Tightener Pulley	Tightener Pulley	Tightener Pulley
					
İmsp.Ref.	457.1633	470.0015	470.0016	460.1970	
Orj. Ref.	000 550 16 33	470 001 00 15	470 155 00 16	460 200 19 70	
Description	Double Ball Pulley	Tightener Pulley	Tightener Pulley	Tightener Pulley	



Dortrenk Turizm Gayr. Mot.Tas.San. ve Tic. Ltd.Şti.
Tax Administration & No:
 Ikitelli / 313 058 5172
Address :
 Ikitelli O.S.B Dolapdere Sanayi Sitesi 12.Ada No:56
 Basaksehir / Istanbul / Turkiye
Tel :+90 (212) 243 02 03 Fax: +90 (212) 355 02 42
Email: bilgi@otobusyedeckparca.com

01-2017

For MERCEDES.BENZ SPRINTER TIGHTENER PULLEY WITH BEARING

İmsp.Ref.	315.0019	315.0220
Orj. Ref.	000 202 0019	646 200 0220
Description	315 CDI	315 CDI

For MAN TIGHTENER PULLEY WITH BEARING

FORTUNA / STARLINER / TOURISMO			
İmsp.Ref.	5195.6096	5195.6020	5195.6061
Orj. Ref.	51.95800.6096	51.95800.6020	51.95800.6061
Description	Fortuna New/Mod.	Tightener Pulley	Tightener Pulley
			TG.A 410 Tightener Pulley
İmsp.Ref.	906.2070	5195.6092	5195.6087
Orj. Ref.	51.95800.7436	51.95800.6092	51.95800.6087
Description	Tightener Pulley	FORTUNA BUS	Tightener Pulley

SCANIA TIGHTENER PULLEY WITH BEARING



İmsp.Ref.	124.3717	124.9979	124.1119	124.6970
Orj. Ref.	1353717	3979997	1510698	080866970
Description	Tightener Pulley	Tightener Pulley	Tightener Pulley	Tightener Pulley





Dortrenk Turizm Gayr. Mot.Tas.San. ve Tic. Ltd.Şti.
Tax Administration & No:
 Ikitelli / 313 058 5172
Address :
 Ikitelli O.S.B Dolapdere Sanayi Sitesi 12.Ada No:56
 Basaksehir / Istanbul / Turkiye
Tel :+90 (212) 243 02 03 Fax: +90 (212) 355 02 42
Email: bilgi@otobusyedekparca.com

01-2017



VOLVO TIGHTENER PULLEY WITH BEARING

			
İmsp.Ref.	124.4314	124.6970	
Orj. Ref.	3154314	08086970	
Description	Tightener Pulley	Tightener Pulley	Tightener Pulley

For VOLKSWAGEN TIGHTENER PULLEY WITH BEARING

			
İmsp.Ref.	35.5261	35.0938	35.3610
Orj. Ref.	076 145 261A	076 260 938A	076 145 276A
Description	LT35 Tightener Pulley	Crafter Tightener Pulley	LT35 Tightener Pulley

For FORD CUMMINS TIGHTENER PULLEY WITH BEARING

			
İmsp.Ref.			
Description			
Orj. Ref.	Tightener Pulley	Tightener Pulley	Tightener Pulley



Dortrenk Turizm Gayr. Mot.Tas.San. ve Tic. Ltd.Şti.

Tax Administration & No:

Ikitelli / 313 058 5172

Adress :

Ikitelli O.S.B Dolapdere Sanayi Sitesi 12.Ada No:56

Basaksehir / Istanbul / Turkiye

Tel :+90 (212) 243 02 03 Fax: +90 (212) 355 02 42

Email: bilgi@otobusyedekparca.com

01-2017



Dortrenk Turizm Gayr. Mot.Tas.San. ve Tic. Ltd.Şti.

Tax Administration & No:

Ikitelli / 313 058 5172

Adress :

Ikitelli O.S.B Dolapdere Sanayi Sitesi 12.Ada No:56

Basaksehir / Istanbul / Turkiye

Tel :+90 (212) 243 02 03 Fax: +90 (212) 355 02 42

Email: bilgi@otobusyedekparca.com

01-2017

OIL COOLLER FILTER



SECTION



Dortrenk Turizm Gayr. Mot.Tas.San. ve Tic. Ltd.Şti.
Tax Administration & No:
 Ikitelli / 313 058 5172
Adress :
 Ikitelli O.S.B Dolapdere Sanayi Sitesi 12.Ada No:56
 Basaksehir / Istanbul / Turkiye
Tel :+90 (212) 243 02 03 Fax: +90 (212) 355 02 42
Email: bilgi@otobusyedekparca.com

01-2017

FOR MERCEDES-BENZ OIL COOLER				
				
İmsp.Ref.	904.2665	906.6765	364.1265	355.1165
DESCRIPTION	Oil Cooler Atego	Oil Cooler Axor	Oil Cooler OM 364 5 Storey	Oil Cooler 6 Storey
Orj. Ref.	000 180 26 65	000 180 67 65	355 180 12 65	355 180 11 65
				
İmsp.Ref.	366.3865	442.8801	404.0001	541.0201
DESCRIPTION	Oil Cooler OM 366	Oil Cooler 10 Storey	Oil Cooler 10 Storey	Oil Cooler 12 Storey
Orj. Ref.	366 180 38 65	001 188 88 01	422 188 00 01	541 188 02 01
				
İmsp.Ref.	2648.2301	442.4301	442.3101	281.0121
DESCRIPTION	Oil Cooler 20 Storey	Oil Cooler 13 Storey	Oil Cooler 10 Storey	MAN 9 Storey
Orj. Ref.	002 188 23 01	002 188 4301	001 188 31 01	51.05601.0121
				
İmsp.Ref.	422.1801	422.0101	0826.0108	000 438 07 88
DESCRIPTION	Oil Cooler 10 Degrees	Oil Cooler 10 Flat	Oil Cooler (12.153 7'li)	Retarder Boiler
Orj. Ref.	002 188 18 01	422 188 01 01	51.05601.0108	
				
İmsp.Ref.	2066-0161	2066-7176	180-0179	180-0155
DESCRIPTION	Oil Cooler E/M 10 Storey	Oil Cooler 11 Storey	Oil Cooler 18.240	Oil Cooler 12.240
Orj. Ref.	51.05601-0161	51.05601-7176	51.05601-0179	51.05601-0155
				
İmsp.Ref.	541.0601			
DESCRIPTION	Oil Cooler 14' Deck			
Orj. Ref.	541.0601			



Dortrenk Turizm Gayr. Mot.Tas.San. ve Tic. Ltd.Şti.
Tax Administration & No:
 Ikitelli / 313 058 5172
Address :
 Ikitelli O.S.B Dolapdere Sanayi Sitesi 12.Ada No:56
 Basaksehir / Istanbul / Turkiye
Tel :+90 (212) 243 02 03 Fax: +90 (212) 355 02 42
Email: bilgi@otobusyedekparca.com

01-2017

ADBLUE FILTER CHASSIS WATER SEPARATOR

					
İmsp.Ref.	457.0289	457.0389	457.0390	457.0578	
Description	Adblue Filter	Adblue Filter	Adblue Repair Kit	Adblue Pump	
Orj. Ref.	000 142 02 89	000 142 03 89		000 140 05 78	
					
MERCEDES			For IVECO / SCANIA/FORD		
İmsp.Ref.	70070	70071	70072	457-0580	
Description	Adblue Cover	Adblue Cover	Adblue Cover	Pump Top	
Orj. Ref.					
					
İmsp.Ref.	70073	70074	1000.2516	124.1390	
Description	Adblue Cover	Fuel Store Cover	Separ Cover	Separ Cover For Scania	
Orj. Ref.			000 477 25 16	23311-1390	
					
MERCEDES-MAN					
İmsp.Ref.	502-6415	457-4615	1000-2517	H240-0798	425-61605
Description	Imbusat Store Cover	Radiator Cover	Volvo Separ Store	MAN Retarder Filter	Adblue Filter
Orj. Ref.	000 501 64 15	000 501 46 15	11110737	0501210798	42561605
					
MERCEDES			TRAVEGO- O 403		
İmsp.Ref.	MR01	MR07	460-0468	401-0068	
Description	Water Separator	Engine Over Filter	Oil Cover	Steering Oil Cover	
Orj. Ref.	000 477 13 02	E500KP02	352 010 04 68	000 466 00 68	



Dortrenk Turizm Gayr. Mot.Tas.San. ve Tic. Ltd.Şti.
Tax Administration & No:
 Ikitelli / 313 058 5172
Address :
 Ikitelli O.S.B Dolapdere Sanayi Sitesi 12.Ada No:56
 Basaksehir / Istanbul / Turkiye
Tel :+90 (212) 243 02 03 Fax: +90 (212) 355 02 42
Email: bilgi@otobusyedekparca.com

01-2017

TRANSFER PUMP, AUTOMATIC, FILTER, FILTER COVER

				
İmsp.Ref. 240.0085	240.0003	240.0006	240.0004	
Description Separ Filter 10	Separ filtre 9	Separ Glass 5	Separ Glass 10	
Orj. Ref. 81.12503.0085	85.12501.0003	81125120006	81125120004	
				
İmsp.Ref. 906.4708	541.0208	240.6003	906.2438	
Description Fuel Filter Cover 1840	Oil Filter Cover 1840	TGA Fuel Filter Cover	906 Oil Filter Cover	
Orj. Ref. 000 092 52 08	541 184 02 08		000 180 24 38	
				
İmsp.Ref. 906.4707	1000-2520	240.0208	366-0119	
Description Fuel Filter Cover	Switch	TGA Oil Filter Cover	Compressor Elbow Pipe Nail	
Orj. Ref. 000 090 00 87			366 010 01 19	
				
İmsp.Ref. 906-120	906-121	401-4502	366-2424	401-1367
Description Oil Filter Valve	Oil Filter Valve 4 Nail	Steering Hydraulic Storage	Steering Hydraulic Storage	Steering Oil Dipstick Axor Switch
Orj. Ref.		000 466 45 02	000 466 60 47	000 466 13 67
				
İmsp.Ref. 18-40	18-41	2066-2441	24-40	32-28
Description Axor 1840 Oil Breakwater	1840 Axor Fuel Breakwater	Oil Breakwater	Man-TGA Breakwater	Axor 906 Breakwater
Orj. Ref.				



Dortrenk Turizm Gayr. Mot.Tas.San. ve Tic. Ltd.Şti.
Tax Administration & No:
 Ikitelli / 313 058 5172
Adress :
 Ikitelli O.S.B Dolapdere Sanayi Sitesi 12.Ada No:56
 Basaksehir / Istanbul / Turkiye
Tel :+90 (212) 243 02 03 Fax: +90 (212) 355 02 42
Email: bilgi@otobusyedekparca.com

01-2017

ADBLUE FILTRE CHASSIS WATER SEPARATOR

		ELEKTRİKLİ					
İmsp.Ref.	MR03	MR04		MR03-1		MR04.1	
Description	Separ	Separ Electric		Fuel Automatic Not Electric		Fuel Automatic Electric	
Orj. Ref.		000 470 04 69					
İmsp.Ref.	457-0025	TX1871		TX1879		TX1883	
Description	Valve	Thermostat 71		Thermostat 79		Thermostat 83	
Orj. Ref.	973 011 00 22						
İmsp.Ref.	MR01.2012	MR01.7123		MR05		MR01.8850	
Description	Fuel-Oil Resting Bottle	Fuel-Oil Resting Bottle		2521 Fuel-Oil Automatic		Fuel-Oil Hand Pump	
Orj. Ref.	000 090 02 12	145 743 40 00		000 090 74 50		244 701 00 33	
İmsp.Ref.	MR01.2190	MR01.9250		MR01.300		MR01.301	
Description	Fuel-Oil Automatic	Fuel-Oil Automatic		Transfer Pump		Transfer Stone Set.	
Orj. Ref.	000 910 21 90	000 090 92 50		000 090 60 50		000 090 07 51	
İmsp.Ref.	MR03.1	MR04.1					
Description	Fuel-Oil Automatic (No Electric)	Fuel-Oil Automatic (Electric)					
Orj. Ref.							



Dortrenk Turizm Gayr. Mot.Tas.San. ve Tic. Ltd.Şti.

Tax Administration & No:

Ikitelli / 313 058 5172

Adress :

Ikitelli O.S.B Dolapdere Sanayi Sitesi 12.Ada No:56
Basaksehir / Istanbul / Turkiye

Tel :+90 (212) 243 02 03 Fax: +90 (212) 355 02 42

Email: bilgi@otobusyedekparca.com

01-2017

--	--	--	--	--



Dortrenk Turizm Gayr. Mot.Tas.San. ve Tic. Ltd.Şti.

Tax Administration & No:

Ikitelli / 313 058 5172

Adress :

Ikitelli O.S.B Dolapdere Sanayi Sitesi 12.Ada No:56
Basaksehir / Istanbul / Turkiye

Tel :+90 (212) 243 02 03 Fax: +90 (212) 355 02 42

Email: bilgi@otobusyedekparca.com

01-2017



Dortrenk Turizm Gayr. Mot.Tas.San. ve Tic. Ltd.Şti.

Tax Administration & No:

Ikitelli / 313 058 5172

Adress :

Ikitelli O.S.B Dolapdere Sanayi Sitesi 12.Ada No:56

Basaksehir / Istanbul / Turkiye

Tel :+90 (212) 243 02 03 Fax: +90 (212) 355 02 42

Email: bilgi@otobusyedeckparca.com

01-2017

SPARE PARTS



SECTION



Dortrenk Turizm Gayr. Mot.Tas.San. ve Tic. Ltd.Şti.

Tax Administration & No:

Ikitelli / 313 058 5172

Adress :

Ikitelli O.S.B Dolapdere Sanayi Sitesi 12.Ada No:56

Basaksehir / Istanbul / Turkiye

Tel :+90 (212) 243 02 03 Fax: +90 (212) 355 02 42

Email: bilgi@otobusyedekparca.com

01-2017



Dortrenk Turizm Gayr. Mot.Tas.San. ve Tic. Ltd.Şti.
Tax Administration & No:
 İkitelli / 313 058 5172
Address :
 İkitelli O.S.B Dolapdere Sanayi Sitesi 12.Ada No:56
 Basaksehir / Istanbul / Turkiye
Tel :+90 (212) 243 02 03 Fax: +90 (212) 355 02 42
Email: bilgi@otobusyedekparca.com

01-2017

MAN/MERCEDES-BENZ-CYLINDER LINER-VALVE FELT



























İmsp.Ref.	280.607	281.607	441.607	442.607	
Description	Cylinder Liner Tire Set	Cylinder Liner Tire Set	Cylinder Liner Tire Set	Cylinder Liner Tire Set	
Orj. Ref.		51 96501 0412		025 997 8548	
İmsp.Ref.	457.607	501.607	906.506	457.0059	
Description	Cylinder Liner Tire Set	Cylinder Liner Tire Set	Turbine O-ring	O-ring	
Orj. Ref.	457 997 0045	541 011 0059		460 011 0059	
İmsp.Ref.	457-607-1	299.607	441.608	442.608	
Description	Cylinder Liner Euro 4	Cylinder Liner Repair Sapphire	Cylinder Liner	Cylinder Liner	
Orj. Ref.	457 997 00 45				
İmsp.Ref.	457.608	501.608	541.603	501.290	457-6547
Description	Cylinder Liner	Cylinder Liner	Turbine O-ring	Steering Pump O-ring	Valve Felt Euro
Orj. Ref.	457 011 0259	541 011 1045			002 997 65 47
İmsp.Ref.	401.0196	501.3558	906.0358	366.0058	
Description	Valve Felt	Valve Felt	Valve Felt	Valve Felt	
Orj. Ref.	422 053 0196	000 053 3558	906 053 0358	3660530058	
İmsp.Ref.	366.0158	0826-0029	180-0034	M04 / M06 / M08 / M10 / M12	
Description	Valve Felt	Valve Felt 26270-32270	Valve Felt TGL 12180-12240	Metric Types Available	
Orj. Ref.	3660530158	51.04902-0029	51.04902-0034		



Dortrenk Turizm Gayr. Mot.Tas.San. ve Tic. Ltd.Şti.
Tax Administration & No:
 Ikitelli / 313 058 5172
Address :
 Ikitelli O.S.B Dolapdere Sanayi Sitesi 12.Ada No:56
 Basaksehir / Istanbul / Turkiye
Tel :+90 (212) 243 02 03 Fax: +90 (212) 355 02 42
Email: bilgi@otobusyedekparca.com

01-2017

EXHAUST BOLT/AIR PRESSURE TUBE/VALVE

						
İmsp.Ref. 457.96761	457.0330	457.0331	457-0332			
Description Air Pressure Tube	Valve Cover Aluminum	Valve Cover Plastic	Valve Cover Aluminum Ventilation			
Orj. Ref. 004 432 57 01	457 010 03 30	457 010 03 30	457 010 05 30			
						
İmsp.Ref. 501.0501	906.165	457.0401	457.165			
Description Cylinder Cover Stub	Exhaust Bolt	Cylinder Cover Stub	Exhaust Bolt			
Orj. Ref. 541 990 05 01	904 990 04 12	457 990 04 01				
						
İmsp.Ref. 460-166	906-166	460-165	M10-166	M10-166	240-165	0836.165
Description Intake Manifold Stub	Exhaust Manifold Set	Exhaust Stud New Model 1840	Turbine Stud Metric 10	Turbine Nut Metric 10	MAN Exhaust Bolt	Exhaust Bolt
Orj. Ref. 906 016 04 69						
						
İmsp.Ref. 442-1410	442-1411	502-077	906-0660	906.0474		
Description Steering Cross Stamp	Steering Cross Stamp	1840 Oil Pressure Valve	Injecttor Stamp	Thermostat Pipe		
Orj. Ref. 000 132 14 10	000 132 14 10		906 017 0660	904 203 04 74		
						
İmsp.Ref. 442-2153	457-2727-2	457-0062	441-023	457-0610		
Description Clutch Flange Repair Kit	Tower Repair Kit Ball	Piston Tower Repair Kit	Fuel Automatic Valve	Fuel Automatic Repair Kit		
Orj. Ref. 210 350 21 53		421 350 00 62	2 447 010 023			
						



Dortrenk Turizm Gayr. Mot.Tas.San. ve Tic. Ltd.Şti.
Tax Administration & No:
 Ikitelli / 313 058 5172
Address :
 Ikitelli O.S.B Dolapdere Sanayi Sitesi 12.Ada No:56
 Basaksehir / Istanbul / Turkiye
Tel :+90 (212) 243 02 03 Fax: +90 (212) 355 02 42
Email: bilgi@otobusyedekparca.com

01-2017

İmsp.Ref.	457-165-1			
Description	Exhaust Bolt Pump			
Orj. Ref.				

VALVE / FOOT STOP BUTTON

					
İmsp.Ref.	600.5001	600.5002	600.5006	600.5007	
Description	Bellows Valve	Bellows Valve	Bellows Valve	Bellows Valve	
Orj. Ref.	050 000 5001	050 000 5002	050 000 5006	050 000 5007	
					
İmsp.Ref.	366.3523	366.3525	442.2125	457.8200	
Description	Stop Valve	Reinforced Valve	Steel Valve	Charge Dynamo Stamp	
Orj. Ref.	000 434 2301		000 327 21 25		
					
İmsp.Ref.	103983	101983	102983	501.551	906.0127
Description	Felt (Front)	Felt (Back)	Felt (Man Front Billed)	Injector Stamp	Felt Support Stamp
Orj. Ref.	442 031 00 27	403 032 03 09	403 035 07 27		946 356 0127
					
İmsp.Ref.	600.5003	600.5004	501.6919	460.4919	460.6119
Description	Bellows Valve (Hard)	Bellows Valve (Soft)	Cabin Bellows (Actros)	Cabin Bellows (1840 Front)	Cabin Bellows (1840 Back)
Orj. Ref.			940 890 69 19	940 890 49 19	942 890 61 19
					
İmsp.Ref.					
Description	Turbine Oil Pipe	Turbine Oil Pipe	Turbine Oil Pipe	Turbine Oil Pipe (1840)	
Orj. Ref.					
					
İmsp.Ref.	401.3112	366.4290	366.4290.1	366.1512	
Description	Gas Piston 3031.403	Exhaust Brake Piston	Exhaust Brake Piston (30' LUK)	Gas Piston	
Orj. Ref.		421 429 00 00		000 072 15 12	



Dortrenk Turizm Gayr. Mot.Tas.San. ve Tic. Ltd.Şti.
Tax Administration & No:
 İkitelli / 313 058 5172
Address :
 İkitelli O.S.B Dolapdere Sanayi Sitesi 12.Ada No:56
 Basaksehir / İstanbul / Türkiye
Tel :+90 (212) 243 02 03 Fax: +90 (212) 355 02 42
Email: bilgi@otobusyedekparca.com

01-2017

BRAKE BELLOWS STONE/VALVE RODS

							
İmsp.Ref.	240.0192	457.0192	16	20			
Description	Fender Rubber	Fender Rubber	Brake Bellows Stone	Brake Bellows Stone			
Orj. Ref.	81.6644.0192	050 000 01 92					
							
İmsp.Ref.	24	27	30	36			
Description	Brake Bellows Stone	Brake Bellows Stone	Brake Bellows Stone	Brake Bellows Stone			
Orj. Ref.							
							
İmsp.Ref.	30X30X8	50X20X10	50X30X10	40X30X8			
Description	A Type Wedge	B Type Wedge	A Type Wedge	B Type Wedge			
Orj. Ref.							
							
İmsp.Ref.	40X30X8A	30X30B	50X40X10	75X45X12			
Description	A Type Wedge	B Type Wedge	B Type Wedge	B Type Wedge			
Orj. Ref.							
							
İmsp.Ref.	30X20X8	30X25X8	M-294	457-0484			
Description	B Type Wedge	A Type Wedge	Exhaust Hanger Wedge	Bellows Valve			
Orj. Ref.			000 491 02 85	942 325 04 84			



Dortrenk Turizm Gayr. Mot.Tas.San. ve Tic. Ltd.Şti.
Tax Administration & No:
 Ikitelli / 313 058 5172
Address :
 Ikitelli O.S.B Dolapdere Sanayi Sitesi 12.Ada No:56
 Basaksehir / Istanbul / Turkiye
Tel :+90 (212) 243 02 03 Fax: +90 (212) 355 02 42
Email: bilgi@otobusyedekparca.com

01-2017

BRAKE BELLOWS STONE/VALVE RODS

			
İmsp.Ref. 442.001	442.002	442.003	442.004
Description Valve Rod	Valve Rod	Valve Rod	Valve Rod
Orj. Ref. KISA 22 cm	ORTA 24 cm	UZUN 32 cm	EKSTRA UZUN 40 cm
			
İmsp.Ref. M750	M751	442.005	442.006
Description Charge Dynamo Bushing	Travego Charge Dynamo Tensioner Bushing	Valve Head	Valve Head
Orj. Ref. 353 155 00 50	353 155 01 50	8x8	8x6
			
İmsp.Ref. 906-0082	906-0701	457-0011	457.0010
Description Compressor Oil Cat Pipe	Compressor Oil Cat Pipe	Brake Coil Valve	Clutch Valve Axor
Orj. Ref. 906 180 00 82	906 134 07 01		
			
İmsp.Ref. 366-2501	029-150	366-2515	906-0015
Description Compressor Suction Piper	Compressor Intermediate Pipe	2521 Water Pump Intermediate Pipe	906 Water Pump Intermediate Pipe
Orj. Ref.	457 130 00 90	366 203 25 15	906 203 00 15
			
İmsp.Ref. M760	366.0672	366.1272	366.1435
Description Door Rotu TRAVEGO	Charge Dynamo Tensioner Iron	Charge Dynamo Tensioner Iron	Compressor Dynamo Tensioner Iron
Orj. Ref.	366 150 06 72	314 150 12 72	366 130 14 35
			
İmsp.Ref. 457.8090	457.1535 1840	457-0254	457-0255
Description Pulley Foot	Charge Dynamo Foot	Weather Record Elbow	Weather Record T Type
Orj. Ref. 457 205 06 40	4571551535		



Dortrenk Turizm Gayr. Mot.Tas.San. ve Tic. Ltd.Şti.
Tax Administration & No:
 Ikitelli / 313 058 5172
Adress :
 Ikitelli O.S.B Dolapdere Sanayi Sitesi 12.Ada No:56
 Basaksehir / Istanbul / Turkiye
Tel :+90 (212) 243 02 03 Fax: +90 (212) 355 02 42
Email: bilgi@otobusyedekparca.com

01-2017

EXHAUST BUTTERFLIES

			
İmsp.Ref. 366.167	460.167	457.167	904.167
Description 2521.2517 Exhaust Brake Butterfly	Eurp 4/5 Exhaust Brake Butterfly (Add Blue Type)	Euro 3 / 1840 Exhaust Brake Butterfly	Atego Exhaust Brake Butterfly
Orj. Ref. 366 140 30 53	457 140 30 53	457 140 22 53	904 140 25 53
 EURO 4		 EURO 4	
İmsp.Ref. 924.167	906.167	926.167	19422.167
Description Atego Exhaust Brake Butterfly	Axor Egzoz Exhaust Butterfly	Axor Exhaust Brake Butterfly	Man 19422 Exhaust Brake Butterfly
Orj. Ref.	906 140 03 53		81156016057
			
İmsp.Ref. 0826.167	281.167	240.167	2066.167
Description 26230 Exhaust Brake Butterfly	26281 Exhaust Brake Butterfly	TGA 18410 Exhaust Brake Butterfly	TGA 430 Exhaust Brake Butterfly
Orj. Ref. 81156006080	81156006106	81156006111	51152016174 51152016183
			
İmsp.Ref. 366.0063	906.0063	457.0163	906.0163
Description Butterfly Joint	904 Butterfly Repair Kit	1840 Butterfly Repair Kit	906 Butterfly Repair Kit
Orj. Ref.	904 140 00 63	541 140 01 63	906 140 00 63
			
İmsp.Ref. 366.2353	441.0363		
Description 2521 Butterfly Repair Kit	88'lik Butterfly Repair Kit		
Orj. Ref. 366 140 23 53	441 140 03 63		



Dortrenk Turizm Gayr. Mot.Tas.San. ve Tic. Ltd.Şti.
Tax Administration & No:
Ikitelli / 313 058 5172
Address :
Ikitelli O.S.B Dolapdere Sanayi Sitesi 12.Ada No:56
Basaksehir / Istanbul / Turkiye
Tel :+90 (212) 243 02 03 Fax: +90 (212) 355 02 42
Email: bilgi@otobusyedekparca.com

01-2017

STEERING REPAIR KIT

LS 6

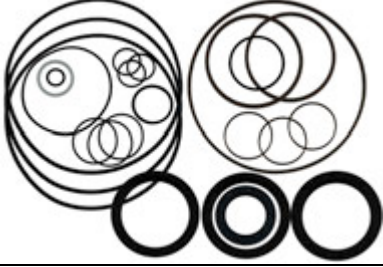

LS 8

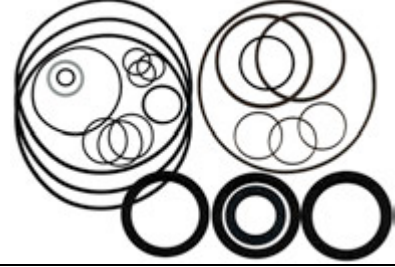

İmsp.Ref.	LS6.100	LS8.100
Description	Steering Repair Kit	Steering Repair Kit
Orj. Ref.		
		
İmsp.Ref.	1266962	
Description	Steering Felt Axor / Actros	
Orj. Ref.	023 997 19 47	



Dortrenk Turizm Gayr. Mot.Tas.San. ve Tic. Ltd.Şti.

Tax Administration & No:

Ikitelli / 313 058 5172

Adress :

Ikitelli O.S.B Dolapdere Sanayi Sitesi 12.Ada No:56

Basaksehir / Istanbul / Turkiye

Tel :+90 (212) 243 02 03 Fax: +90 (212) 355 02 42

Email: bilgi@otobusyedekparca.com

01-2017

SENSOR



SECTION



Dortrenk Turizm Gayr. Mot.Tas.San. ve Tic. Ltd.Şti.
Tax Administration & No:
 Ikitelli / 313 058 5172
Address :
 Ikitelli O.S.B Dolapdere Sanayi Sitesi 12.Ada No:56
 Basaksehir / Istanbul / Turkiye
Tel :+90 (212) 243 02 03 Fax: +90 (212) 355 02 42
Email: bilgi@otobusyedekparca.com

01-2017

FOR MAN-MERCEDES / SENSOR

			
O 304 / O 403	TRAVEGO	AXOR-ACTROS	O 403
İmsp.Ref. 401-2317	457-4417	501-0217	
Description Water Level Switch	Water Level Switch	Water Level Switch	Kilometer Switch
Orj. Ref. 010 542 23 17	002 541 44 17	942 542 02 17	012 542 49 17
			
O 403 - AXOR	MAN	TRAVEGO-ACTROS-AXOR	TRAVEGO-AXOR-ACTROS
İmsp.Ref. 403-6217	280-0080	501-7309	501-4709
Description Kilometer Switch	Kilometer Switch	Empty Gear Switch	Back Gear Switch
Orj. Ref. 013 542 62 17	81.27421.0080	001 545 73 09	001 545 47 09
			
TRAVEGO-AXOR-ACTROS	AXOR-ACTROS	O 403 - O 304	MAN-IVECO-MERCEDES
İmsp.Ref. 501-4909	501-9218	403-0917	401- 7117
Description Help Switch	Gearbox Switch	Overheated Switch	Oil Switch 10 Bar
Orj. Ref. 001 545 49 09	000 542 92 18. 91 18	007 542 09 17. 002 542 73 17	005 545 71 17
			
MERCEDES	MERCEDES	MERCEDES	MERCEDES
İmsp.Ref. 401-8917	401-1717	401-9417	401-1017
Description Oil Switch Single Plug 0,5 Bar	Oil Switch Double Plug 0,5 Bar	Kilometer Switch 3 Plug	Kilometer Switch 4 Plug
Orj. Ref. 004 542 89 17	002 542 17 17	005 542 94 17	009 542 10 17
			
TRAVEGO	AXOR	MERCEDES	MAN-MERCEDES
İmsp.Ref. 457-4328	457-9932	401-2317	423-7317
Description Overheated Switch	Oil Switch	Overheated Switch	Overheated Switch
Orj. Ref. 004 153 43 28	000 153 99 32	001 542 23 17	002 542 73 17. 81.27421.0125



Dortrenk Turizm Gayr. Mot.Tas.San. ve Tic. Ltd.Şti.
Tax Administration & No:
 Ikitelli / 313 058 5172
Address :
 Ikitelli O.S.B Dolapdere Sanayi Sitesi 12.Ada No:56
 Basaksehir / Istanbul / Turkiye
Tel :+90 (212) 243 02 03 Fax: +90 (212) 355 02 42
Email: bilgi@otobusyedekparca.com

01-2017

FOR MAN-MERCEDES SENSOR

			
423 MAN	423 MAN	281 MAN	MAN
İmsp.Ref.	423-0134	423-0171	281-0080
Description	Brake Switch	Brake Switch	Oil Switch
Orj. Ref.	81.25520.0134	51.25520.0171	81.27421.0088
			
MERCEDES	TRAVEGO	TRAVEGO-AXOR-ACTROS	TRAVEGO
İmsp.Ref.	457-2717	457-7717	457-0828
Description	Kilometer Switch 3	Weather Pressure Switch	Oil Switch
Orj. Ref.	015 542 27 17	012 542 77 17	007 153 08 28
			
MAN-FORTUNA-TGA	2521 MERCEDES	MERCEDES-MAN	SETRA-TRAVEGO-AXOR-ACTROS
İmsp.Ref.	2066-0216	366-2417	401-6909
Description	MANIFOLD MÜŞÜRÜ	KILOMETRE MÜŞÜRÜ	FREN BEYİNİ
Orj. Ref.	028 100 26 55 51.27421.0216	012 542 24 17	000 545 69 09
			
TGA MAN	TGA MAN	TGA MAN	MERCEDES O 403
İmsp.Ref.	240-0246	240-0184	442-2909
Description	Oil Pressure Sensor	Oil Pressure Sensor	Back Gear Switch
Orj. Ref.	51.27421.0246 51.27421.0262	81.27421.0184	81.25514.0036
			
TRAVEGO-SETRA	TRAVEGO-SETRA-ACTROS-AXOR	TRAVEGO-SETRA-EURO3	TRAVEGO-SETRA-EURO4
İmsp.Ref.	502-0640	502-4428	457-9428
Description	Gearbox Switch	Sump Level Sensor	Sump Level Sensor
Orj. Ref.	00 542 92 18	004 153 44 28	004 153 94 28
			006 153 12 28



Dortrenk Turizm Gayr. Mot.Tas.San. ve Tic. Ltd.Şti.
Tax Administration & No:
 Ikitelli / 313 058 5172
Adress :
 Ikitelli O.S.B Dolapdere Sanayi Sitesi 12.Ada No:56
 Basaksehir / Istanbul / Turkiye
Tel :+90 (212) 243 02 03 Fax: +90 (212) 355 02 42
Email: bilgi@otobusyedekparca.com

01-2017

FOR MAN-MERCEDES SENSOR

							
904 ATEGO		906 AXOR		TRAVEGO-ACTROS-AXOR-EURO3		TRAVEGO-ACTROS-AXOR-EURO3	
İmsp.Ref.	502-9828	502 -6328	457-5617	457-5514	457-5514	457-5514	457-5514
Description	Sump Level Sensor	Sump Level Sensor	Rev Switch	Hand Brake Switch 6,5 Bar	Hand Brake Switch 6,5 Bar	Hand Brake Switch 6,5 Bar	Hand Brake Switch 6,5 Bar
Orj. Ref.	003 153 98 28	004 153 63 28	012 542 56 17	004 545 55 17	004 545 55 17	004 545 55 17	004 545 55 17
							
TRAVEGO-ACTROS-AXOR-ATEGO		TRAVEGO-ACTROS-AXOR-ATEGO		TRAVEGO-ACTROS-AXOR-ATEGO		TRAVEGO-SETRA	
İmsp.Ref.	457-7524	457-7624	457-0224	457-3217	457-3217	457-3217	457-3217
Description	Heat Level Switch	Water Evacuation Switch	Water Evacuation Switch	Gearbox Switch-ASTRO	Gearbox Switch-ASTRO	Gearbox Switch-ASTRO	Gearbox Switch-ASTRO
Orj. Ref.	008 545 75 24	008 545 76 24	008 545 02 24	014 542 32 17	014 542 32 17	014 542 32 17	014 542 32 17
							
TRAVEGO-SETRA		AXOR-ATEGO		AXOR-ATEGO		MAN	
İmsp.Ref.	457-9018	906-2409	906-1828	422-0097	422-0097	422-0097	422-0097
Description	Gearbox EPC Sensor	Brake Switch	Intake Manifold Sensor	Oil Switch 0,10 Bar	Oil Switch 0,10 Bar	Oil Switch 0,10 Bar	Oil Switch 0,10 Bar
Orj. Ref.	000 542 90 18	001 545 24 09	004 153 18 28	81.2742. 0097	81.2742. 0097	81.2742. 0097	81.2742. 0097
							
MERCEDES-MAN		TRAVEGO-SETRA		TRAVEGO-SETRA-AXOR		MERCEDES-MAN	
İmsp.Ref.	441-3907	441-0021	457-6390	472-2000	472-2000	472-2000	472-2000
Description	Weather Pressure Sensor 5 V	Weather Pressure Sensor 24V	Stop Coil	Solenoid Coil	Solenoid Coil	Solenoid Coil	Solenoid Coil
Orj. Ref.	000 430 39 07	441 043 00 21	472 070 63 90	472 170 70 00	472 170 70 00	472 170 70 00	472 170 70 00
							
MERCEDES		NEOPLAN-SCAINA-IVECO		MERCEDES-MAN-NEOPLAN-IVECO		MERCEDES-MAN	
İmsp.Ref.	472-0000	472-6060	457-6000	472-7000	472-7000	472-7000	472-7000
Description	Solenoid Coil	Solenoid Coil	Solenoid Coil	Solenoid Coil	Solenoid Coil	Solenoid Coil	Solenoid Coil
Orj. Ref.	472 171 00 00	472 170 60 60	472 170 60 00	472 170 70 00	472 170 70 00	472 170 70 00	472 170 70 00



Dortrenk Turizm Gayr. Mot.Tas.San. ve Tic. Ltd.Şti.
Tax Administration & No:
 Ikitelli / 313 058 5172
Address :
 Ikitelli O.S.B Dolapdere Sanayi Sitesi 12.Ada No:56
 Basaksehir / Istanbul / Turkiye
Tel :+90 (212) 243 02 03 Fax: +90 (212) 355 02 42
Email: bilgi@otobusyedekparca.com

01-2017

FOR MAN-MERCEDES SENSOR

 MAN				
İmsp.Ref.	472-4280	442-416	442-417	457-7332
Description	Solenoid Coil	Craw E/M	Craw Y/M	Tick Tock Breakwater
Orj. Ref.	472 171 42 80	008 997 62 72	008 997 62 72	41277322
				
İmsp.Ref.	442-0364	442-0813	502-1490	457-0690
Description	Tick Tock Repair Kit	Tick Tock Coil	Intekol Clamp 108*130	Intekol Clamp 95*114
Orj. Ref.	41290364	001 431 08 13	005 997 14 90	005 997 06 90
 MERCEDES-MAN		 O 403 – EURO3		
İmsp.Ref.	366-5735	457-2120	M11	M12
Description	Engine Ventilation	Flywheel Sensor	Gear Jump Articulated	Gear Jump Articulated
Orj. Ref.	000 018 57 35	001 153 21 20	000 268 61 89.6289	000 268 47 89.5580
 O 403				
İmsp.Ref.	457-9508	906-8134	124-3979	906-1931
Description	Contact Switch	Brake Hose Record	Fuel Filter Breakwater	Gear Lever Articulated
Orj. Ref.	000 545 95 08	000 997 81 34		001 981 19 31



Dortrenk Turizm Gayr. Mot.Tas.San. ve Tic. Ltd.Şti.

Tax Administration & No:

Ikitelli / 313 058 5172

Adress :

Ikitelli O.S.B Dolapdere Sanayi Sitesi 12.Ada No:56

Basaksehir / Istanbul / Turkiye

Tel :+90 (212) 243 02 03 Fax: +90 (212) 355 02 42

Email: bilgi@otobusyedekparca.com

01-2017



Dortrenk Turizm Gayr. Mot.Tas.San. ve Tic. Ltd.Şti.

Tax Administration & No:

Ikitelli / 313 058 5172

Adress :

Ikitelli O.S.B Dolapdere Sanayi Sitesi 12.Ada No:56

Basaksehir / Istanbul / Turkiye

Tel :+90 (212) 243 02 03 Fax: +90 (212) 355 02 42

Email: bilgi@otobusyedekparca.com

01-2017

INTERCOL PIPE FUEL TRANSFER PUMP



SECTION



Dortrenk Turizm Gayr. Mot.Tas.San. ve Tic. Ltd.Şti.

Tax Administration & No:

Ikitelli / 313 058 5172

Adress :

Ikitelli O.S.B Dolapdere Sanayi Sitesi 12.Ada No:56

Basaksehir / Istanbul / Turkiye

Tel :+90 (212) 243 02 03 Fax: +90 (212) 355 02 42

Email: bilgi@otobusyedeckparca.com















01-2017

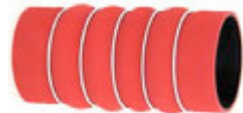

Dortrenk Turizm Gayr. Mot.Tas.San. ve Tic. Ltd.Şti.
Tax Administration & No:
 İkitelli / 313 058 5172
Address :
 İkitelli O.S.B Dolapdere Sanayi Sitesi 12.Ada No:56
 Basaksehir / İstanbul / Türkiye
Tel :+90 (212) 243 02 03 Fax: +90 (212) 355 02 42
Email: bilgi@otobusyedeckparca.com

01-2017

FOR MAN-MERCEDES / SENSOR

							
TRAVEGO		AXOR RETARDER ELBOW HOSE		AXOR RETARDER TAREPED HOSE		AXOR RETARDER FLAT HOSE	
İmsp.Ref.	M-1036	M-1042	M-1045	M-1043			
Description	Tareped Hose Q100X115X130	Elbow Hose 50*70*110	Tareped Hose 50*60*105	Flat Hose 50*120			
Orj. Ref.	000 997 06 53	944 997 00 82	942 501 05 82	943 997 21 82			
							
TRAVEGO		TRAVEGO		457		AXOR-ATEGO-906-904	
İmsp.Ref.	M-1008	M-1010	M-1011	M-1015			
Description	Intercol Hose 115x160	Intercol Hose Q100X190 MM	Intercol Hose Q100X205 MM	Intercol Hose Q85X200			
Orj. Ref.	002 997 54 52	024 997 03 82	002 094 63 82	000 501 60 82			
							
MAN-FOTUNA		TRAVEGO		ACTROS-TRAVEGO 501			
İmsp.Ref.	M-2002	M-1017	M-1001	M-1023			
Description	Intercol Hose 90X290	Intercol Hose Q115X100 MM	Flat Hose Q15X90 MM	Flat Hose Q22X90 MM			
Orj. Ref.	81.96301-0900	001 501 88 82					
							
İmsp.Ref.	M-1005	M-1026	M-1027	M-1034			
Description	Intercol Hose 2521	Retarder Conic Hose 50x150	Retarder Conic Hose 50x200	Retarder Conic Hose 60x150			
Orj. Ref.	002 094 18 82						



Dortrenk Turizm Gayr. Mot.Tas.San. ve Tic. Ltd.Şti.
Tax Administration & No:
 İkitelli / 313 058 5172
Address :
 İkitelli O.S.B Dolapdere Sanayi Sitesi 12.Ada No:56
 Basaksehir / İstanbul / Türkiye
Tel :+90 (212) 243 02 03 Fax: +90 (212) 355 02 42
Email: bilgi@otobusyedekparca.com

01-2017

FOR MAN.MERCEDES HOSES

							
1840 OLD MODEL		OM 366 / 2521		1840 NEW MODEL		TRAVEGO NEW MODEL	
İmsp.Ref.	457.1982	366.0082		457.0382		460.0282	
Description	Air Suction Hose	Air Suction Hose		940 528 19 82		Turbo Elbow Hose	
Orj. Ref.	940 528 19 82	615 528 00 82		958 528 03 82		634 820 01 86	
							
İmsp.Ref.	366.0183	457.0091		441.0182		M-2027	
Description	Turbo Suction Hose	Suction Bellows Hose		Hose		Retarder Conic Hose 60x200	
Orj. Ref.	366 098 01 83	942 528 00 91		655 528 01 82			
		 AXOR 906		 TRAVEGO OLD MODEL			
İmsp.Ref.	441-1614	906-1670		457-7552		S-4002	
Description	Weather Filter Bellows 2631-3031	AXOR Weather Elbow Hose		Turbo Elbow Hose		Intercol Hose 80x182	
Orj. Ref.	655 528 01 82	940 528 09 82		002 997 75 52			
							
İmsp.Ref.	S-4003						
Description	Intercol Hose 80x182						
Orj. Ref.	1522011						



Dortrenk Turizm Gayr. Mot.Tas.San. ve Tic. Ltd.Şti.
Tax Administration & No:
 Ikitelli / 313 058 5172
Address :
 Ikitelli O.S.B Dolapdere Sanayi Sitesi 12.Ada No:56
 Basaksehir / Istanbul / Turkiye
Tel :+90 (212) 243 02 03 Fax: +90 (212) 355 02 42
Email: bilgi@otobusyedekparca.com

01-2017

FOR MERCEDES VENTILATION HOSE-NUT

					
İmsp.Ref.	457-0570	457-1364		457-1270	
Description	Engine Ventilation Hose	Sump Side Oil Filling Pipe		Ventilation Pipe	
Orj. Ref.	457 010 05 70	457 010 13 64		457 010 12 70	
					
LONG		SHORT			
İmsp.Ref.	457-0757	457-0457		9405280709	
Description	Compressor Suction Pipe Long	Compressor Suction Pipe Short		Oil Filling Pipe	
Orj. Ref.	457 130 07 57	457 130 04 57		940 528 07 09	
					
İmsp.Ref.	457-3457	8101.6015		471-0115	
Description	Compressor Suction Pipe	Oil Filling Hose MAN		ABS Circle Pipe Y/M	
Orj. Ref.	457 130 34 57			943 334 01 15	
					
İmsp.Ref.	1840-0226	904-0015	460-8150	460-0126	
Description	Hive Nut	Hive Nut	Hive Nut	Hive Nut	
Orj. Ref.	946 356 02 26	652 356 00 15	002 990 81 50	942 356 01 26	
					
İmsp.Ref.	03-150	03-310	457-334	457-356	
Description	SAF 5000 ABS Iron	BPW DORSE ABS	ABS Sensor Iron Front	ABS Iron Back	
Orj. Ref.		940 030 03 10	942 334 00 15	942 356 07 15	



Dortrenk Turizm Gayr. Mot.Tas.San. ve Tic. Ltd.Şti.

Tax Administration & No:

Ikitelli / 313 058 5172

Adress :

Ikitelli O.S.B Dolapdere Sanayi Sitesi 12.Ada No:56

Basaksehir / Istanbul / Turkiye

Tel :+90 (212) 243 02 03 Fax: +90 (212) 355 02 42

Email: bilgi@otobusyedekparca.com

01-2017

DAF SCANIA VOLVO

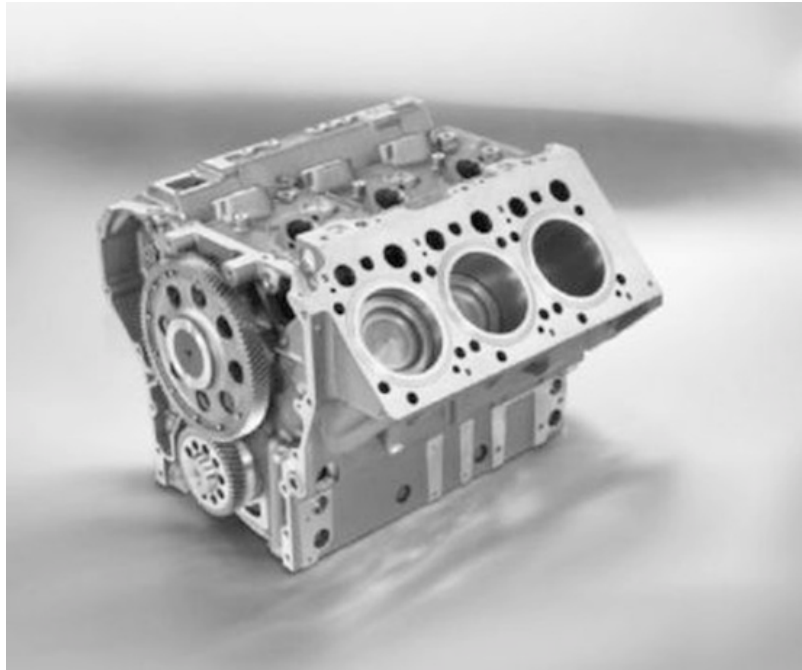











SECTION



Dortrenk Turizm Gayr. Mot.Tas.San. ve Tic. Ltd.Şti.
Tax Administration & No:
 İkitelli / 313 058 5172
Address :
 İkitelli O.S.B Dolapdere Sanayi Sitesi 12.Ada No:56
 Basaksehir / İstanbul / Türkiye
Tel :+90 (212) 243 02 03 Fax: +90 (212) 355 02 42
Email: bilgi@otobusyedekparca.com

01-2017

DAF XF-95











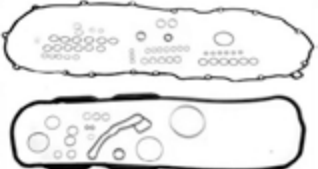
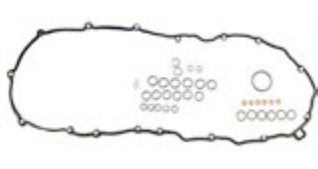



					
İmsp.Ref.	XF95.050	XF95.060		XF95.080	
DESCRIPTION	Cylinder Gasket	Oil Pan Gasket Nbr		Valve Cover Gasket	
Orj. Ref.					
Unit \$					
					
İmsp.Ref.	XF95.160	XF95.150	XF95.010	XF95.081	
DESCRIPTION	Exhaust Manifold	Intake Manifold	Gasket	Valve Cover Gasket	
Orj. Ref.		471 175-7			
Unit \$					
					
İmsp.Ref.	XF95.131	XF95.132	XF95.203		
DESCRIPTION	Water Pump Gasket	Water Pump Gasket	Gasket		
Orj. Ref.					
Unit \$					

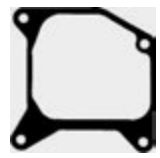

Dortrenk Turizm Gayr. Mot.Tas.San. ve Tic. Ltd.Şti.
Tax Administration & No:
 İkitelli / 313 058 5172
Adress :
 İkitelli O.S.B Dolapdere Sanayi Sitesi 12.Ada No:56
 Basaksehir / İstanbul / Türkiye
Tel :+90 (212) 243 02 03 Fax: +90 (212) 355 02 42
Email: bilgi@otobusyedekparca.com

01-2017

DAF XF105 CF85







			
İmsp.Ref. XF105.100	XF105.101	XF105.102	XF105.060
Description Full Repair Gasket	Top Repair Gasket	Lower Repair Gasket	Oil Pan Gasket
Orj. Ref. 0683657	0683657	0683658	1315381-1458701
			
İmsp.Ref. XF105.080	XF105.050	XF105.210	XF105.150
Description Rocker Arm Cover Gasket	Cylinder Cover Gasket	Oil Filter Connection Tyre	Intake Tyre
Orj. Ref. 1656305	1690107	1643075	1444986
			
İmsp.Ref. XF105.160	XF105.150	XF105.603	XF105.604
Description Exhaust Manifold Gasket	Intake Manifold Gasket	Cer Tyre	Rocker Arm Cover Tyre
Orj. Ref. 1639810	1623719-1907399	114554-114555	241144
			
İmsp.Ref. XF105.605	XF105.606	XF105.607	
Description Oil Pipe Tyre	Oil Pipe Tyre	Shirt Tyre	
Orj. Ref. 1608393	1608394	1603977	



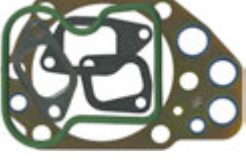

Dortrenk Turizm Gayr. Mot.Tas.San. ve Tic. Ltd.Şti.
Tax Administration & No:
 Ikitelli / 313 058 5172
Address :
 Ikitelli O.S.B Dolapdere Sanayi Sitesi 12.Ada No:56
 Basaksehir / Istanbul / Turkiye
Tel :+90 (212) 243 02 03 Fax: +90 (212) 355 02 42
Email: bilgi@otobusyedeckparca.com

01-2017

SCANIA / DC 91993 MODEL

			
İmsp.Ref. DC9.101	DC9.050	DC9.080	DC9.150
DESCRIPTION Cylinder Full Set	Cylinder Cover	Valve Cover	Intake Manifold
Orj. Ref. 551 484	1 403 258	378 299	366 547
Unit \$			
			
İmsp.Ref. DC9.155	DC9.160	DSC9.060	
DESCRIPTION Suction Pipe Gasket	Exhaust Gasket	Oil Pan Gasket	
Orj. Ref.	364 792		
Unit \$			

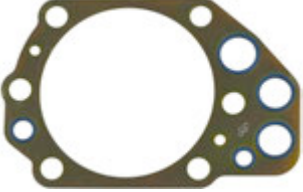
SCANIA / DC9 1994 MODEL

		
İmsp.Ref. DC9.050	DC9.080	DC9.151
DESCRIPTION Cylinder Gasket	Valve Cover Gasket	Intake Manifold Gasket
Orj. Ref. 1 403 258	378 299	1 437 296
Unit \$		



Dortrenk Turizm Gayr. Mot.Tas.San. ve Tic. Ltd.Şti.
Tax Administration & No:
 Ikitelli / 313 058 5172
Address :
 Ikitelli O.S.B Dolapdere Sanayi Sitesi 12.Ada No:56
 Basaksehir / Istanbul / Turkiye
Tel :+90 (212) 243 02 03 Fax: +90 (212) 355 02 42
Email: bilgi@otobusyedekparca.com

01-2017

SCANIA / DC 13













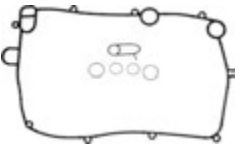
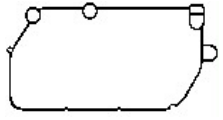

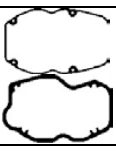

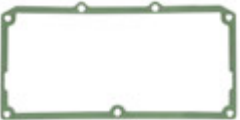



İmsp.Ref.	113.060	DC13.060	126.060	113.080
DESCRIPTION	Oil Pan Gasket	Oil Pan Gasket	Oil Pan Gasket	Valve Cover
Orj. Ref.	371 503	1520507	Elr No: 381952	258 459
Unit \$				
İmsp.Ref.	113.150	113.151	113.152	113.153
DESCRIPTION	Gasket	Gasket	Gasket	Gasket
Orj. Ref.	1 384 552	1 384 555	1 384 554	
Unit \$				
İmsp.Ref.	113.160	113.161	113.162	113.163
DESCRIPTION	Gasket	Gasket	Gasket	Gasket
Orj. Ref.	378 264	1 109 288	385 997	385 998
Unit \$				
İmsp.Ref.	113.401	113.402	113.403	113.404
DESCRIPTION	Gasket	Gasket	Gasket	Gasket
Orj. Ref.				
Unit \$				
İmsp.Ref.	113.405	113.406	113.407	113.408
DESCRIPTION	Gasket	Gasket	Gasket	Gasket
Orj. Ref.				
Unit \$				

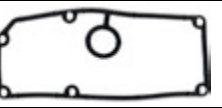

Dortrenk Turizm Gayr. Mot.Tas.San. ve Tic. Ltd.Şti.
Tax Administration & No:
 İkitelli / 313 058 5172
Adress :
 İkitelli O.S.B Dolapdere Sanayi Sitesi 12.Ada No:56
 Basaksehir / Istanbul / Turkiye
Tel :+90 (212) 243 02 03 Fax: +90 (212) 355 02 42
Email: bilgi@otobusyedekparca.com

01-2017

SCANIA / DC,9-DC,11-DC,12-DT,12-DSC,12

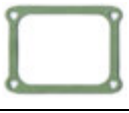
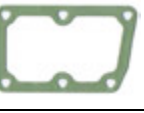









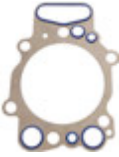

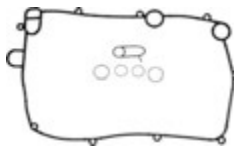
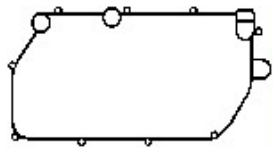
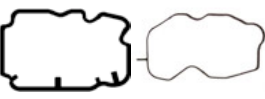

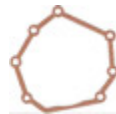





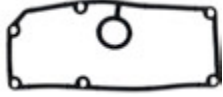



				
İmsp.Ref. 123.050	124.060	123.070	123.071	
DESCRIPTION Cylinder Gasket	Oil Pan Gasket	Oil RPCS. Radiator	Oil RPCS. Radiator	
Orj. Ref. 1 444 941		1502798	1502798	
Unit \$				
				
İmsp.Ref. 124.073	123.080	123.081	123.082	124.090
DESCRIPTION Oil Cooler Gasket	Valve Cover Set	Valve Cover	Valve Cover	Side Cover Gasket
Orj. Ref. 1375383		1 367 028	1 367 027	1374326
Unit \$				
				
İmsp.Ref. 124.150	124.160	124.261	124.132	
DESCRIPTION Intake Manifold	Exhaust Manifold	Thermostat Gasket	Water Pump Inner Gasket	
Orj. Ref. 1 516 474	1 336 138		1 403 883	
Unit \$				
				
İmsp.Ref. 123.010	124.011	124.010	124.131	
DESCRIPTION Gasket	Gasket	Gasket	Water Pump Gasket	
Orj. Ref. 1896605	1374334		1541633	
Unit \$				
				
İmsp.Ref. 124.305	124.074	124.151	124.304	
DESCRIPTION Gasket	Oil Billet Rubber	Suction O-ring	Gasket	
Orj. Ref. 1382187	1367849	1390211		
Unit \$				
				
İmsp.Ref. 124.260	124.013	124.305	124.306	
DESCRIPTION Thermostat con	Front Gasket	Gasket	Gasket	
Orj. Ref. 1374333	1375387		1374325	
Unit \$				



Dortrenk Turizm Gayr. Mot.Tas.San. ve Tic. Ltd.Şti.
Tax Administration & No:
 Ikitelli / 313 058 5172
Address :
 Ikitelli O.S.B Dolapdere Sanayi Sitesi 12.Ada No:56
 Basaksehir / Istanbul / Turkiye
Tel :+90 (212) 243 02 03 Fax: +90 (212) 355 02 42
Email: bilgi@otobusyedekparca.com

01-2017

SCANIA / DC,9-DC,11-DC,12-DT,12-DSC,12-DC,16 ,1, 2









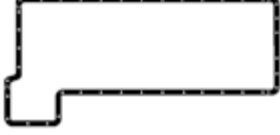

				
İmsp.Ref.	124.050	124.060	124.070	124.071
DESCRIPTION	Cylinder Gasket	Oil Pan Gasket		
Orj. Ref.	1892765		1249497	1249497
Unit \$				
				
İmsp.Ref.	124.080	124.081	124.082	124.401
DESCRIPTION	Valve Cover	Valve Cover	Valve Cover	Pitu Gasket
Orj. Ref.	1 476 506	1 476 506	1 449 542	1374327
Unit \$				
				
İmsp.Ref.	124.080-1	124-081-1	124.073	124.090
DESCRIPTION	Valve Cover	Valve Cover	Gasket	Gasket
Orj. Ref.			1375383	1374326
Unit \$				
				
İmsp.Ref.	123.010	124.011	124.010	124.131
DESCRIPTION	Gasket	Gasket	Gasket	Water Pump Gasket
Orj. Ref.	1896605	1374334		1541633
Unit \$				
				
İmsp.Ref.	124.150	124.160	124.261	124.301
DESCRIPTION	Intake Manifold	Exhaust Manifold	Thermostat Gasket	Gasket
Orj. Ref.	1 516 474	1 336 138		1391726
Unit \$				
				
İmsp.Ref.	124.302	124.304	124.303	
DESCRIPTION	Gasket	Gasket	Gasket	
Orj. Ref.				
Unit \$				

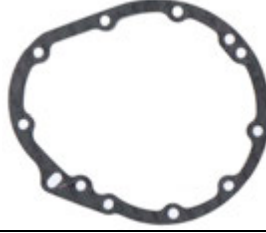

Dortrenk Turizm Gayr. Mot.Tas.San. ve Tic. Ltd.Şti.
Tax Administration & No:
 Ikitelli / 313 058 5172
Address :
 Ikitelli O.S.B Dolapdere Sanayi Sitesi 12.Ada No:56
 Basaksehir / Istanbul / Turkiye
Tel :+90 (212) 243 02 03 Fax: +90 (212) 355 02 42
Email: bilgi@otobusyedekparca.com

01-2017

SCANIA D-DS-DSC 14-141

				
İmsp.Ref. 141.050	141.060	141.090	141.080	
DESCRIPTION Cylinder Gasket	Oil Pan Gasket	Side Cover Gasket	Valve Cover	
Orj. Ref. 1 403 587	371 505		1 305 959	
Unit \$				
				
İmsp.Ref. 141.112	141.010	141.011	141.091	
DESCRIPTION Flywheel Gasket	Eccentric Cover	Gasket	Gasket	
Orj. Ref.				
Unit \$				
				
İmsp.Ref. 141.150	141.152	141.160	141.085	141.153
DESCRIPTION Intake Manifold	Gasket	Exhaust Manifold	Gasket	Gasket
Orj. Ref. 1 392 459		369 276		
Unit \$				



Dortrenk Turizm Gayr. Mot.Tas.San. ve Tic. Ltd.Şti.

Tax Administration & No:

Ikitelli / 313 058 5172

Adress :

Ikitelli O.S.B Dolapdere Sanayi Sitesi 12.Ada No:56

Basaksehir / Istanbul / Turkiye

Tel :+90 (212) 243 02 03 Fax: +90 (212) 355 02 42

Email: bilgi@otobusyedekparca.com

01-2017

INTERNATIONAL MANUFACTURER SPARE PARTS

HOSE



PART 1







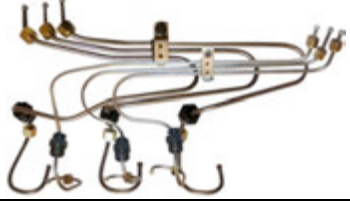

Dortrenk Turizm Gayr. Mot.Tas.San. ve Tic. Ltd.Şti.
Tax Administration & No:
 Ikitelli / 313 058 5172
Address :
 Ikitelli O.S.B Dolapdere Sanayi Sitesi 12.Ada No:56
 Basaksehir / Istanbul / Turkiye
Tel :+90 (212) 243 02 03 Fax: +90 (212) 355 02 42
Email: bilgi@otobusyedekparca.com

01-2017

For MERCEDES.BENZ OM-352

			
352.1500	352.1501	352.1502	
IMSP Ref	Orj.Ref.	DESCRIPTION	Unit
352.1500		INJECTOR PIPE	1 Pcs
352.1501		INJECTOR PIPE R	1 Pcs
352.1502		INJECTOR PIPE L	1 Pcs

For MERCEDES.BENZ OM-360-302

			
302.1500	302.2501	302.2502	
			
302.2601	302.2301	302.2001	302.2002
IMSP Ref	Orj.Ref.	DESCRIPTION	Unit
302.1500		INJECTOR PIPE	1 Pcs
302.2301		BRAKE HOSE	1 Pcs
302.2501		COMPRESSOR HOSE NEW MODEL	1 Pcs
302.2502		COMPRESSOR HOSE OLD MODEL	1 Pcs
302.2601		FUEL HOSE	1 Pcs
302.2001		STEERING HOSE (NOT RAKOR) (Axor)	1 Pcs
302.2002		STEERING HOSE (RAKOR)	1 Pcs



Dortrenk Turizm Gayr. Mot.Tas.San. ve Tic. Ltd.Şti.

Tax Administration & No:

Ikitelli / 313 058 5172

Address :

Ikitelli O.S.B Dolapdere Sanayi Sitesi 12.Ada No:56

Basaksehir / Istanbul / Turkiye

Tel :+90 (212) 243 02 03 Fax: +90 (212) 355 02 42

Email: bilgi@otobusyedekparca.com

01-2017

For MERCEDES.BENZ OM-364



IMSP Ref	Orj.Ref.	DESCRIPTION	Unit	Price
364.1500		INJECTOR PIPE	1 Pc	

For MERCEDES.BENZ OM-366



366.1500



366.2505



366.2001

IMSP Ref	Orj.Ref.	DESCRIPTION	Unit	Price
366.1500		INJECTOR PIPE	1 Pcs	
366.2001		STEERING HOSE	1 Pcs	
366.2505		COMPRESSOR OIL HOSE	1 Pcs	



Dortrenk Turizm Gayr. Mot.Tas.San. ve Tic. Ltd.Şti.
Tax Administration & No:
 Ikitelli / 313 058 5172
Address :
 Ikitelli O.S.B Dolapdere Sanayi Sitesi 12.Ada No:56
 Basaksehir / Istanbul / Turkiye
Tel :+90 (212) 243 02 03 Fax: +90 (212) 355 02 42
Email: bilgi@otobusyedekparca.com

01-2017

For MERCEDES.BENZ OM-401-421 V/6 3031

401.1501	401.1502	401.2503	
401.2302	401.2301 K	401.2720	
401.2601	401.2502	401.2501	
IMSP Ref	Orj.Ref.	DESCRIPTION	Unit
401.1500		INJECTOR PIPE V/6 - 3031	1 Pcs
401.1501		INJECTOR PIPE (L)	1 Pcs
401.1502		INJECTOR PIPE (R)	1 Pcs
401.2302		FRONT BRAKE HOSE (LONG)	1 Pcs
401.2301		REAR BRAKE BELLOWS HOSE(SHORT)	1 Pcs
401.2501		COMPRESSOR HOSE	1 Pcs
401.2502		COMPRESSOR HOSE (TEFLON)	1 Pcs
401.2503		WATER HOSE	1 Pcs
401.2601		FUEL HOSE	1 Pcs
401.2720		CLUTCH LUBRICATION HOSE	1 Pcs



Dortrenk Turizm Gayr. Mot.Tas.San. ve Tic. Ltd.Şti.
Tax Administration & No:
 Ikitelli / 313 058 5172
Address :
 Ikitelli O.S.B Dolapdere Sanayi Sitesi 12.Ada No:56
 Basaksehir / Istanbul / Turkiye
Tel :+90 (212) 243 02 03 Fax: +90 (212) 355 02 42
Email: bilgi@otobusyedekparca.com

01-2017

For MERCEDES.BENZ OM 441 / LA 3031

441.2504		441-2503		
IMSP Ref	Orj.Ref.	DESCRIPTION	Unit	Price
441.2503		COMPRESSOR AIR PIPE (30-31)	1 Pcs	
441.2504		STEERING HOSE(30-31)	1 Pcs	

For MERCEDES.BENZ OM-402-422 V/8

402.1501		402.1502		401.2503	
401.2301 SHORT		401.2302 FRONT		401.2720	
401.2501		401.2601		401.2502	
IMSP Ref	Orj.Ref.	DESCRIPTION	Unit	Price	
402.1500		INJECTOR PIPE V/8	1 Pcs		
402.1501		INJECTOR PIPE (L)	1 Pcs		
402.1502		INJECTOR PIPE (R)	1 Pcs		
401.2302		FRONT BRAKE HOSE (LONG)	1 Pcs		
401.2301		REAR BRAKE BELLOW HOSE (SHORT)	1 Pcs		
401.2501		COMPRESSOR HOSE	1 Pcs		
401.2502		COMPRESSOR HOSE (TEFLON)	1 Pcs		
407.2503		WATER HOSE SORU İŞATETİ	1 Pcs		
401.2601		FUEL HOSE	1 Pcs		
401.2720		CLUTCH LUBRICATION HOSE	1 Pcs		



Dortrenk Turizm Gayr. Mot.Tas.San. ve Tic. Ltd.Şti.

Tax Administration & No:

Ikitelli / 313 058 5172

Adress :

Ikitelli O.S.B Dolapdere Sanayi Sitesi 12.Ada No:56

Basaksehir / Istanbul / Turkiye

Tel :+90 (212) 243 02 03 Fax: +90 (212) 355 02 42

Email: bilgi@otobusyedekparca.com











01-2017

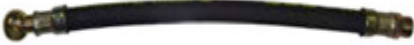

Dortrenk Turizm Gayr. Mot.Tas.San. ve Tic. Ltd.Şti.
Tax Administration & No:
 Ikitelli / 313 058 5172
Adress :
 Ikitelli O.S.B Dolapdere Sanayi Sitesi 12.Ada No:56
 Basaksehir / Istanbul / Turkiye
Tel :+90 (212) 243 02 03 Fax: +90 (212) 355 02 42
Email: bilgi@otobusyedekparca.com

01-2017

For MERCEDES.BENZ OM-442-LA O-403

				
442.1501	442.1502	442.2302		
				
442.2502	442.2720	442.2721		
				
442.2650	442.2651	442.5511		
				
442.5510				
IMSP Ref	Orj.Ref.	DESCRIPTION	Unit	Price
442.1500		INJECTOR PIPE 403	1 Pcs	
442.1501		INJECTOR PIPE (L)	1 Pcs	
442.1502		INJECTOR PIPE (R)	1 Pcs	
442.2502		COMPRESSOR HOSE TEFLON	1 Pcs	
442.2302		FRONT BRAKE HOSE (LONG)	1 Pcs	
442.2650		STOP HORTUMU	1 Pcs	
442.2651		STEERING HOSE 403	1 Pcs	
442.2720		CLUTCH AIR HOSE	1 Pcs	
442.2721		CLUTCH HYDRAULIC HOSE	1 Pcs	
442.5510	442 180 06 20	TURBINE OIL PIPE	1 Pcs	
442.5511	442 180 05 20	TURBINE OIL PIPE	1 Pcs	



Dortrenk Turizm Gayr. Mot.Tas.San. ve Tic. Ltd.Şti.

Tax Administration & No:

Ikitelli / 313 058 5172

Adress :

Ikitelli O.S.B Dolapdere Sanayi Sitesi 12.Ada No:56

Basaksehir / Istanbul / Turkiye

Tel :+90 (212) 243 02 03 Fax: +90 (212) 355 02 42

Email: bilgi@otobusyedekparca.com

01-2017

PART 2



Dortrenk Turizm Gayr. Mot.Tas.San. ve Tic. Ltd.Şti.
Tax Administration & No:
Ikitelli / 313 058 5172
Adress :
Ikitelli O.S.B Dolapdere Sanayi Sitesi 12.Ada No:56
Basaksehir / Istanbul / Turkiye
Tel :+90 (212) 243 02 03 Fax: +90 (212) 355 02 42
Email: bilgi@otobusyedekparca.com

01-2017



For MERCEDES-BENZ AXOR 1840 / 41.40 / 457 TRAVEGO EURO 3 - EURO 5

457.1501	457.2503	457.2504	
457.2708	457.2701	457.2603	
457.2706	457.5512	457.2707	
457.2704	457.5902	457.2001	
457.4832	457.4048	457.3028	
457.2502	457.2728	457.2729	457.1622
457.2302	457.2303		
457.2506	457.2505		



Dortrenk Turizm Gayr. Mot.Tas.San. ve Tic. Ltd.Şti.
Tax Administration & No:
Ikitelli / 313 058 5172
Address :
Ikitelli O.S.B Dolapdere Sanayi Sitesi 12.Ada No:56
Basaksehir / Istanbul / Turkiye
Tel :+90 (212) 243 02 03 Fax: +90 (212) 355 02 42
Email: bilgi@otobusyedeckparca.com

01-2017

	
457.2726	457.2627

For MERCEDES-BENZ AXOR 1840 457 TRAVEGO EURO 3 EURO 4

IMSP Ref	Orj.Ref.	DESCRIPTION	Unit
457.1500		INJECTOR PIPE SET	1 Set
457.1501	457 070 1333	INJECTOR PIPE	1 Pcs
457.1622	457 180 16 22	TURBINE PIPE	1 Pcs
457.2001	940 997 0152	PCRA TRAVEGO STEERING HOSE EURO 4	1 Pcs
457.2302	946 420 5532	COMPRESSOR AIR PIPE BACK AXOR 1840	1 Pcs
457.2303	940 420 20 26	COMPRESSOR AIR PIPEFRONT AXOR 1840/ 4140	1 Pcs
457.3028	457 200 5052	COMPRESSOR HOSE	1 Pcs
457.4048	000 420 4048	BRAKE HOSE	1 Pcs
457.4837	457 070 4832	FUEL PIPE	1 Pcs
457.2502	001 428 2135	COMPRESSOR HOSE TEFLON	1 Pcs
457.2503	457 200 04 52	COMPRESSOR WATER HOSE (457 TRAVEGO)	1 Pcs
457.2504	457 200 50 52	COMPRESSOR WATER HOSE (Y/M) 457 TRAVEGO	1 Pcs
457.2505	457 200 04 58	WATER HOSE STEEL (457 TRAVEGO EURO 3)	1 Pcs
457.2506	457 200 05 58	WATER HOSE STEEL (AXOR 1840 ÇEKİCİ)	1 Pcs
457.5512	457 180 2020	TURBO OIL PIPE(457 AXOR 1840-4140)	1 Pcs
457.5902	457 200 5902	COOLING WATER PIPE	1 Pcs
457.2603	457 070 13 37	FUEL PIPE (457 TRAVEGO)	1 Pcs
457.2627		COMPRESSOR AIR PIPE TRAVEGO V/8	1 Pcs
457.2701		COMPRESSOR STEERING HOSE (AXOR 4140)	1 Pcs
457.2704	457 200 4952	WATER HOSE (TRAVEGO /AXOR 1840-4140)	1 Pcs
457.2706		AIR PIPE (Euro 4 TRAVEGO 457 NOT AXLE)	1 Pcs
457.2707		AIR PIPE (Euro 4)	1 Pcs
457.2708		COMPRESSOR AIR PIPE TRAVEGO AXOR 1840	1 Pcs
457.2726		COMPRESSOR AIR PIPE TRAVEGO V/8	1 Pcs
457.2728		COMPRESSOR AIR PIPE TRAVEGO V/8	1 Pcs
502.2729		COMPRESSOR AIR PIPE TRAVEGO V/8	1 Pcs
1840.175		CABIN HOSE 1,75 MT	1 Pcs
1840.350		CABIN HOSE 3,50 MT	1 Pcs
1840.450		CABIN HOSE 4,50 MT	1 Pcs
1840.580		CABIN HOSE 5,80 MT	1 Pcs

For MERCEDES.BENZ AXOR 1840 / 41.40 / 457 EURO 4 - EURO 5



Dortrenk Turizm Gayr. Mot.Tas.San. ve Tic. Ltd.Şti.

Tax Administration & No:

Ikitelli / 313 058 5172

Adress :

Ikitelli O.S.B Dolapdere Sanayi Sitesi 12.Ada No:56

Basaksehir / Istanbul / Turkiye

Tel :+90 (212) 243 02 03 Fax: +90 (212) 355 02 42

Email: bilgi@otobusyedekparca.com

01-2017

1840.175	1840.350	1840.580	1840.450



Dortrenk Turizm Gayr. Mot.Tas.San. ve Tic. Ltd.Şti.
Tax Administration & No:
Ikitelli / 313 058 5172
Adress :
Ikitelli O.S.B Dolapdere Sanayi Sitesi 12.Ada No:56
Basaksehir / Istanbul / Turkiye
Tel :+90 (212) 243 02 03 Fax: +90 (212) 355 02 42
Email: bilgi@otobusyedekparca.com

01-2017

For MERCEDES-BENZ AXOR 1840 457 TRAVEGO EURO 3 EURO 4

		
457.1501	457.2602	
		
457.2503	457.2504	
		
457.2502	457.5511	
		
457.2601	457.2507	
		
457.2721	457.2701	
		
457.2305	457.2501	
		
457.2603	457.2708	457.5510
		



Dortrenk Turizm Gayr. Mot.Tas.San. ve Tic. Ltd.Şti.

Tax Administration & No:

Ikitelli / 313 058 5172

Adress :

Ikitelli O.S.B Dolapdere Sanayi Sitesi 12.Ada No:56

Basaksehir / Istanbul / Turkiye

Tel :+90 (212) 243 02 03 Fax: +90 (212) 355 02 42

Email: bilgi@otobusyedekparca.com

01-2017

906.1266

906.1267

457.2304



Dortrenk Turizm Gayr. Mot.Tas.San. ve Tic. Ltd.Şti.

Tax Administration & No:

Ikitelli / 313 058 5172

Address :

Ikitelli O.S.B Dolapdere Sanayi Sitesi 12.Ada No:56

Basaksehir / Istanbul / Turkiye

Tel :+90 (212) 243 02 03 Fax: +90 (212) 355 02 42

Email: bilgi@otobusyedeckparca.com

01-2017



For MERCEDES-BENZ AXOR 1840 457 TRAVEGO EURO 3 – EURO 4

IMSP Ref	Orj.Ref.	DESCRIPTION	Unit	
457.1500		INJECTOR PIPE SET	1 Set	
457.1501	457 070 1333	INJECTOR PIPE	1 Pcs	
457.2501	940 997 05 82	STEERING HOSE AXOR 1840	1 Pcs	
457.2502	001 428 21 35	COMPRESSOR HOSE TEFLON	1 Pcs	
457.2503	457 200 04 52	COMPRESSOR WATER HOSE 457 TRAVEGO	1 Pcs	
457.2504	457 200 50 52	COMPRESSOR WATER HOSE (Y / M) 457 TRAVEGO	1 Pcs	
457.5510	457 180 11 20	TURBINE OIL PIPE 457 TRAVEGO (FLANGE)	1 Pcs	
457.5511	457 180 11 20	TURBINE OIL PIPE	1 Pcs	
457.2601	457 070 17 32	FUEL HOSE (457 TRAVEGO)	1 Pcs	
457.2602	457 070 28 32	FUEL HOSE (457 TRAVEGO)	1 Pcs	
457.2603	457 070 13 37	FUEL PIPE (457 TRAVEGO)	1 Pcs	
457.2721		CLUTCH HYDRAULIC HOSE(OM 403 EURO 3)	1 Pcs	
457.2701		STEERING HOSE(AXOR 4140)	1 Pcs	
457.2708		COMPRESSOR HAVA BORU TRAVEGO AXOR 1840	1 Pcs	
457.2507	629 460 00 24	STEERING HOSE TRAVEGO 457	1 Pcs	
457.2304	457 070 44 32	FUEL PIPE TEFLON (TRAVEGO EURO 4)	1 Pcs	
457.2305	000 476 10 75	FUEL PIPE (TRAVEGO 457 / 502)	1 Pcs	
906.1266	000 257 12 66	CLUTCH HOSE (PENTUSIN)	1 Pcs	
906.1267	000 257 12 67	CLUTCH HYDRAULIC HOSE	1 Pcs	



Dortrenk Turizm Gayr. Mot.Tas.San. ve Tic. Ltd.Şti.
Tax Administration & No:
 Ikitelli / 313 058 5172
Adress :
 Ikitelli O.S.B Dolapdere Sanayi Sitesi 12.Ada No:56
 Basaksehir / Istanbul / Turkiye
Tel :+90 (212) 243 02 03 Fax: +90 (212) 355 02 42
Email: bilgi@otobusyedeckparca.com

01-2017

























For MERCEDES-BENZ OM-501-502 ACTROS V/8 TRAVEGO			
			
501.1501	502.5513	501.2701	541.7932
			
502.5510	502.5511	501.2650	
			
502.6682	502.2724 (LONG)	502.2725 (SHORT)	
For MERCEDES BENZ OM-501-502 ACTROS-1844-1841 V/8 TRAVEGO			
IMSP Ref	Orj.Ref.	DESCRIPTION	Unit
501.1500	541 070 1533	INJECTOR PIPE SET 501 V/6	1 Set
502.1500		INJECTOR PIPE SET 502 V/8	1 Set
501.1501	541 070 1133	INJECTOR PIPE	1 Pcs
501.2650		BACK AXLE HOSE	1 Pcs
502.5510	542 180 1120	TURBINE OIL PIPE - RIGHT	1 Pcs
502.5511	542 180 1220	TURBINE OIL PIPE - LEFT	1 Pcs
501.2701		COMPRESSOR AIR PIPE	1 Pcs
541.7932	541 070 7932	FUEL PIPE 501-502	
502.5513	541 200 3552	COMPRESSOR AIR PIPE TRAVEGO ACTROS	
502.6682	022 997 6682	STEERING HOSE	1 Pcs
502.2724	001 295 00 35	CLUTCH HOSE (LONG)	1 Pcs
502.2725	001 295 99 35	CLUTCH HOSE (SHORT)	1 Pcs



Dortrenk Turizm Gayr. Mot.Tas.San. ve Tic. Ltd.Şti.
Tax Administration & No:
 Ikitelli / 313 058 5172
Adress :
 Ikitelli O.S.B Dolapdere Sanayi Sitesi 12.Ada No:56
 Basaksehir / Istanbul / Turkiye
Tel :+90 (212) 243 02 03 Fax: +90 (212) 355 02 42
Email: bilgi@otobusyedekparca.com

01-2017

For MERCEDES-BENZ 30.28 / 32.28 / 2528 AXOR 906 1517 / 1518 / 2124
ATEGO 904

			
906.1501	906.2603	906.2602	906.2505
			
906.2001	904.2001		904.2504
			
906.2503		906.2604	
			
906.5510	904.2604	906.2504	
			
906.2724 (3.65 cm)	906.2725 (3.28 cm)	906.2726(2.97 cm)	906.2727(2.69 cm)
			
904.2601	906.2301	906.2721 (LONG)	
			
906.2723	906.2601	906.2722 (SHORT)	
			



Dortrenk Turizm Gayr. Mot.Tas.San. ve Tic. Ltd.Şti.

Tax Administration & No:

Ikitelli / 313 058 5172

Adress :

Ikitelli O.S.B Dolapdere Sanayi Sitesi 12.Ada No:56

Basaksehir / Istanbul / Turkiye

Tel :+90 (212) 243 02 03 Fax: +90 (212) 355 02 42

Email: bilgi@otobusyedekparca.com

01-2017

906.2730

906.2731

906.0264



Dortrenk Turizm Gayr. Mot.Tas.San. ve Tic. Ltd.Şti.
Tax Administration & No:
 Ikitelli / 313 058 5172
Address :
 Ikitelli O.S.B Dolapdere Sanayi Sitesi 12.Ada No:56
 Basaksehir / Istanbul / Turkiye
Tel :+90 (212) 243 02 03 Fax: +90 (212) 355 02 42
Email: bilgi@otobusyedekparca.com

01-2017

For MERCEDES.BENZ 32 28 AXOR 906 1517 / 1518 / 2124 ATEGO 904

IMSP Ref	Orj.Ref.	DESCRIPTION	Unit
906.1500	906 070 23 33	INJECTOR PIPE	1 Set
906.1501	906 070 23 33	INJECTOR PIPE	1 Pcs
906.2721	000 257 17 66	CLUTCH HYDRAULIC HOSE (LONG AXOR 1840)	1 Pcs
906.2722	000 257 16 66	CLUTCH HYDRAULIC HOSE SHORT (AXOR 1840)	1 Pcs
906.2723	000 250 02 68	CLUTCH HYDRAULIC HOSE AXOR 1840 EURO 4)	1 Pcs
906.2724	000 295 92 35	CLUTCH HYDRAULIC HOSE (LONG 3.65 cm)	1 Pcs
906.2725	000 295 56 35	CLUTCH HYDRAULIC HOSE (LONG 2.98 cm)	1 Pcs
906.2726	000 250 10 66	CLUTCH HYDRAULIC HOSE (LONG 2.97 cm)	1 Pcs
906.2727	000 250 12 66	CLUTCH HYDRAULIC HOSE (LONG 2.69 cm)	1 Pcs
904.2001		STEERING HOSE (ATEGO 1517/1518)	1 Pcs
906.2001	940 997 05 82	STEERING HOSE (AXOR 906 - 3228)	1 Pcs
906.2601	906 090 12 76	AXOR 906 FUEL PIPE	1 Pcs
904.2601	904 090 09 76	ATEGO FUEL PIPE	1 Pcs
906.2602	906 090 13 76	AXOR 906 FUEL PIPE	1 Pcs
906.2603		906 FUEL PIPE	1 Pcs
906.2604	906 070 25 33	OIL HOSE- 906	1 Pcs
904.2604		OIL HOSEATEGO - 904	1 Pcs
906.2731		AIR PIPE	1 Pcs
906.0264	375 430 02 64	OIL HOSE	1 Pcs
906.2301		REAR BRAKE BELLOW HOSE (SHORT)	1 Pcs
906.2503	906 203 24 02	COMPRESSOR WATER HOSE	1 Pcs
906.2504	906 203 01 02	AXOR 906 COMPRESSOR WATER HOSE	1 Pcs
904.2504	904 203 01 02	ATEGO COMPRESSOR WATER HOSE	1 Pcs
906.2505	906 203 04 02	COMPRESSOR WATER HOSE	1 Pcs
906.2002	940 997 05 82	STEERING HOSE	1 Pcs
906.2730	375 430 02 64	906 AXOR 3228 AIR OUTPUT PIPE	1 Pcs
904.5510	904 997 02 82	TURBO OIL HOSE	1 Pcs
906.5510	906 180 07 20	TURBO OIL HOSE	1 Pcs



Dortrenk Turizm Gayr. Mot.Tas.San. ve Tic. Ltd.Şti.
Tax Administration & No:
Ikitelli / 313 058 5172
Address :
Ikitelli O.S.B Dolapdere Sanayi Sitesi 12.Ada No:56
Basaksehir / Istanbul / Turkiye
Tel :+90 (212) 243 02 03 Fax: +90 (212) 355 02 42
Email: bilgi@otobusyedekparca.com

01-2017

For M.A.N D-2876-2866 MAN TG-A 410-460 FORTUNA



IMSP Ref	Orj.Ref.	DESCRIPTION	Unit	Price
2876.1500		INJECTOR PIPE Pc	1 Set	90,00

For M.A.N SL 222-232



IMSP Ref	Orj.Ref.	DESCRIPTION	Unit	Price
222.1500		INJECTOR PIPE Pc	1 Set	

For M.A.N D26.230-270



IMSP Ref	Orj.Ref.	DESCRIPTION	Unit	Price
270.1500	50.10303.6107	INJECTOR PIPE Pc	1 Set	

For M.A.N 232-270

IMSP Ref	Orj.Ref.	DESCRIPTION	Unit	Price
51103.6177	51.1030.36177	INJECTOR PIPE Pc	1 Set	



Dortrenk Turizm Gayr. Mot.Tas.San. ve Tic. Ltd.Şti.
Tax Administration & No:
 Ikitelli / 313 058 5172
Adress :
 Ikitelli O.S.B Dolapdere Sanayi Sitesi 12.Ada No:56
 Basaksehir / Istanbul / Turkiye
Tel :+90 (212) 243 02 03 Fax: +90 (212) 355 02 42
Email: bilgi@otobusyedekparca.com

01-2017

For M.A.N 19.422-423 MAN



IMSP Ref	Orj.Ref.	DESCRIPTION	Unit
422.1500	51.10303.6130	INJECTOR PIPE Pc	1 Tk.

For M.A.N 19.463-464



IMSP Ref	Orj.Ref.	DESCRIPTION	Unit
463.1500		INJECTOR PIPE Pc	1 Set

For MAN TG-A 2066-430 COMMON-RAIL NEOPLAN STARLINER

2066-1501	2066-1502	2066-1503	2066-1504
2066-1505	2066-1506	2066-1507	
2066.5457	2066-5458	2066-5459	2066-5461
2066.5462			

IMSP Ref	Orj.Ref.	DESCRIPTION	Unit
2066.1500		INJECTOR PIPE	1 Set
2066.1501	51.10304.0148	INJECTOR PIPE	1 Pcs
2066.1502	51.10304.0147	INJECTOR PIPE	1 Pcs
2066.1503	51.10304.0144	INJECTOR PIPE	1 Pcs
2066.1504	51.10304.0149	INJECTOR PIPE	1 Pcs
2066.1505	51.10304.0146	INJECTOR PIPE	1 Pcs
2066.1506	51.10304.0145	INJECTOR PIPE	1 Pcs
2066.1507	51.10304.6080	INJECTOR CENTRAL PIPE	1 Pcs
2066.5457	51 06304 5457	COMPRESSOR HOSE	1 Pcs
2066.5458	51.06304.5458	COMPRESSOR HOSE	1 Pcs
2066.5459	51.06304.5459	COMPRESSOR HOSE	1 Pcs



Dortrenk Turizm Gayr. Mot.Tas.San. ve Tic. Ltd.Şti.

Tax Administration & No:

Ikitelli / 313 058 5172

Address :

Ikitelli O.S.B Dolapdere Sanayi Sitesi 12.Ada No:56

Basaksehir / Istanbul / Turkiye

Tel :+90 (212) 243 02 03 Fax: +90 (212) 355 02 42

Email: bilgi@otobusyedekparca.com

01-2017

2066.5461	51.06304.5461	COMPRESSOR HOSE	1 Pcs	
2066.5462	51.06304.5462	COMPRESSOR HOSE	1 Pcs	

For MITSUBISHI MARATON 713-715 PRENSES

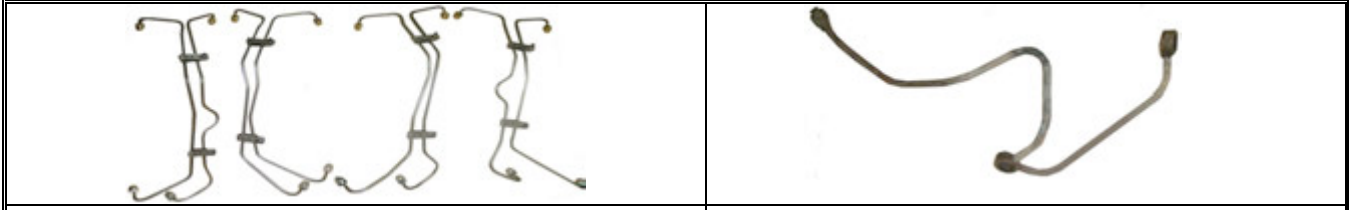

IMSP Ref	Orj.Ref.	DESCRIPTION	Unit	Price
300.1500		INJECTOR PIPE	1 Set	
300.2503		COMPRESSOR WATER HOSE	1 Pcs	

For MITSUBISHI SAFİR

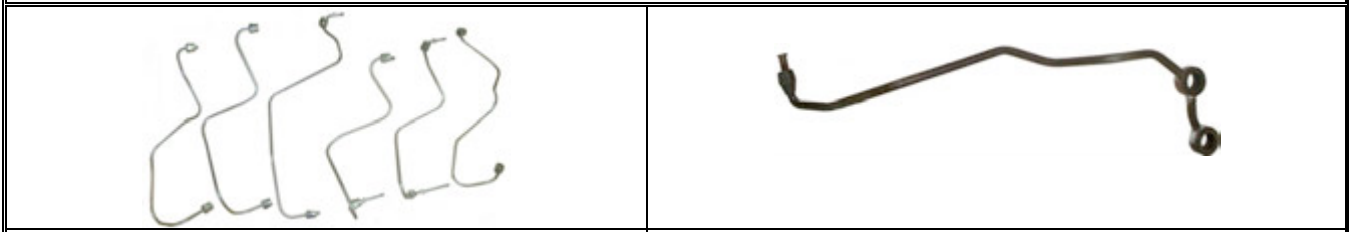





IMSP Ref	Orj.Ref.	DESCRIPTION	Unit	Price
299.1500		INJECTOR PIPE	1 Set	
299.2503		COMPRESSOR WATER HOSE	1 Pcs	



Dortrenk Turizm Gayr. Mot.Tas.San. ve Tic. Ltd.Şti.
Tax Administration & No:
Ikitelli / 313 058 5172
Address :
Ikitelli O.S.B Dolapdere Sanayi Sitesi 12.Ada No:56
Basaksehir / Istanbul / Turkiye
Tel :+90 (212) 243 02 03 Fax: +90 (212) 355 02 42
Email: bilgi@otobusyedekparca.com

01-2017

For MERCEDES BRAKE HOSES

				
457-4048		457-4348		
				
457-4448	457-4548	457-4748		
IMSP Ref	Orj.Ref.	DESCRIPTION	PIECE	PRICE
457-4048	000 420 40 48	BRAKE HOSE 55 CM-POLYAMIDE 56 CM	Pcs.	
457-4348	000 420 43 48	BRAKE HOSE 55 CM-POLYAMIDE 35 CM FLAT	Pcs.	
457-4448	457 420 44 48	BRAKE HOSE 61 CM-POLYAMIDE 38 CM FLAT	Pcs.	
457-4548	457 420 45 48	BRAKE HOSE 55 CM-POLYAMIDE 38 CM FLAT	Pcs.	
457-4748	457 420 47 48	BRAKE HOSE 55 CM-POLYAMIDE 58 CM FLAT	Pcs.	

For MERCEDES TRAVEGO / AXOR EURO 5

				
457.4753		457.5352		
IMSP Ref	Orj.Ref.	DESCRIPTION	Unit	
457.4753		COOLING WATER HOSE	Pcs.	
457.5352		COOLING WATER HOSE	Pcs.	