



ABOUT US

DORTRENK GROUP has started its business in 2013 as a wholesaler and OEM supplier company for the Domestic Market in Turkey. The targeted market was just the domestic market at the beginning but after the year 2015 **DORTRENK GROUP** has started to widen through International Markets beginning with EU countries. By the market needs **DORTRENK GROUP** started to make partnerships by quality well-known factories and widen range of the products to almost 10.000 till today.

DORTRENK GROUP has announced the company as a Group of Companies and its new brands as “**AIRCOLD**” in A/C sector, “**ASSIST**” in replacement parts and “**LPGMAX**” in trailer and LPG sector.

DORTRENK GROUP is a benchmark in the sector with his business model, process management, know-how and consistent sales principles. Thanks to its analytical approach, **DORTRENK GROUP** goes far beyond the role of distributor, in supply and logistics management.

VISION & MISSION

VISION: "To be market maker" in corporate independent aftermarket.

MISSION: To be the benchmark in the sector, with his analytical business model, process approach, know-how based coherent management style.

POLICIES

SERVICE POLICY: Going far beyond the vendor role; analyze the needs of our clients to provide right products and services in at the right time, price and place.

CORPORATE COLLABORATION POLICY: To pursue a transparent collaboration policy both with our customers and our suppliers.

HUMAN RESOURCES POLICY: With its lean management policy to provide maximum level of cooperation among departments, promote personnel development and loyalty.

BUSINESS IMPROVEMENT POLICY: The business processes which has been defined with the participations of all team members has continuously been reviewed and revised to increase efficiency.





DORTRENK GROUP has an aim to be a leading company with the high quality of both products and service, competitive price especially mainly in BUS Parts and Commercial Vehicles produce of EU.

DORTRENK GROUP presents you this wide product range from one point and under one brand which is ASSIST with QUALITY and BEST PRICE perspective.

Additionally, **DORTRENK GROUP** gives you the service of supplying ORIGINAL spare parts of MAN, MERCEDES BENZ, VOLVO and DAF as well as very well-known brands such as below.

Our purpose is giving our customers the service with a well-planned business which enables us to offer them most effective products and satisfy the requirements with a proper service, having quality and competitive prices of all products we supply.

A goal without a plan is just a loss, we would like to realize success for both sides with our working principles at a highest level of meeting the expectancy.

BRANDS





COUNTRIES WE EXPORT

- › Afghanistan
- › Algeria
- › Bulgaria
- › Egypt
- › Estonia
- › Greece
- › Iran
- › Iraq
- › Israel
- › Latvia
- › Libya
- › Oman
- › Poland
- › Qatar
- › Romania
- › Russia
- › Saudi Arabia
- › Slovenia
- › Syria
- › UAE
- › Ukraine
- › Yemen

BRANCH OFFICES

- › Greece
- › Slovenia
- › Russia
- › Poland
- › Bulgaria



PRODUCT GROUP

ENGINE

- › Crankcase
- › Cylinder Head
- › Crankshaft
- › Camshaft
- › Flywheel
- › Flywheel Housing
- › Oil Cooler
- › Oil Cooler Housing
- › Oil Pumps
- › Water Pump
- › Compressor & Parts
- › Piston, Liner, Ring, Rod
- › Starters
- › Alternators
- › Belt / Belt Pulley
- › Gaskets & Gasket Sets
- › Radiators & Intercoolers
- › Silicon Hoses

DRIVETRAIN

- › Clutch Discs
- › Clutch Covers
- › Clutch Bearings
- › Clutch Sets
- › Clutch Repair Kits
- › Clutch Master Cylinders
- › Transmission
- › Transmission Gears
- › Differential Parts
- › Propeller Shaft
- › Shaft Bearings
- › Shaft Spiders

BRAKES

- › Brake Cylinder and Adjuster
- › Parking Brake
- › Brake Disks
- › Brake Calipers
- › Brake Pads
- › Brake Valves
- › Retarder Repair Kit
- › Retarder Oil Cooling
- › Wheel Hub
- › Wheel Covers
- › Wheel Nuts
- › Splash Guards

CHASSIS

- › Air Suspension
- › Shock Absorber
- › Level Adjustment Valves
- › Stabilization
- › Axle Beam

STEERING

- › Power Steering
- › Steering Pump
- › Power Steering Equipment
- › Steering Wheel



PRODUCT GROUP

LIGHTING SYSTEM

- Front Lamp Units
- Rear Lamp Units
- Side Marker Lamps
- Position Lamps
- Additional Lamps
- Interior Illumination
- Switches

BODY&FRAME

- Front Bumper
- Rear Bumper
- Hood & Flap
- Fender
- Door
- Gas Springs
- Accessories
- Extra Baggage

VISIBILITY

- Windshield
- Window Regulator
- Side Windows
- Rear Window
- Outside Mirror
- Inside Rearview Mirror
- Mirror Replacements
- Wiping / Washing

HEATING & VENTILATION

- Blower Motor
- Axial Fans
- Ac Compressor
- Ac Systems Aircold
- Heating
- Propeller

INTERIOR EQUIPMENT

- Instrument Panel
- Passenger Seat Parts
- Passenger Seats
- Floor Covering
- Headrest Covers
- Roller Blinds
- Curtains
- Partition Panels
- Refrigerator Units
- Kitchen Units
- Torpedo refrigerators

ELECTRONICS

- Converter / Inverters
- Amplifier / Microphones
- Ballast
- Relay Units
- Sender Units





ENGINE

- › Crankcase
- › Cylinder Head
- › Crankshaft
- › Camshaft
- › Flywheel
- › Flywheel Housing
- › Oil Cooler
- › Oil Cooler, Filter Housing
- › Oil Pumps
- › Water Pump
- › Compressor & Parts
- › Piston, Liner, Ring, Rod
- › Starters
- › Alternators
- › Belt / Belt Pulleys
- › Gasket & Gasket Sets
- › Radiators & Intercoolers
- › Silicon Hoses





CRANKCASE

The Oil Pans for Crankcases we supply are manufactured by the factories which have more than 20 years experience in High Quality Aluminium&Plastic Casting.



CYLINDER HEAD

The cylinder heads we supply are manufactured by the factories which has been supplying for the aftermarket and also OES to many European brands like MB, Man, Volvo Trucks and Buses.



CRANKSHAFT

We have been offering crankshafts of the factories working Oem & Oes with forged crankshaft which has got annual 1.600.000 pcs production capacity. We also supply BF, SANZ, OE and BALO branded products when demanded.



CAMSHAFT

We have been presenting Camshafts of our ASSIST brand trustfully to the market since last 3 years in behalf of a lot of Europe brands. We also supply BF, SANZ and OE brands depending on the customer demands.



FLYWHEEL

The Flywheels and Gears we supply are very well-known brands and tested for long years by many final users and customers. We can also supply SACHS.



FLYWHEEL HOUSING

The aluminium castings of Housings are made by the standards of ISO16949 and after a serious strict quality controlling process offered to the market by the producers.

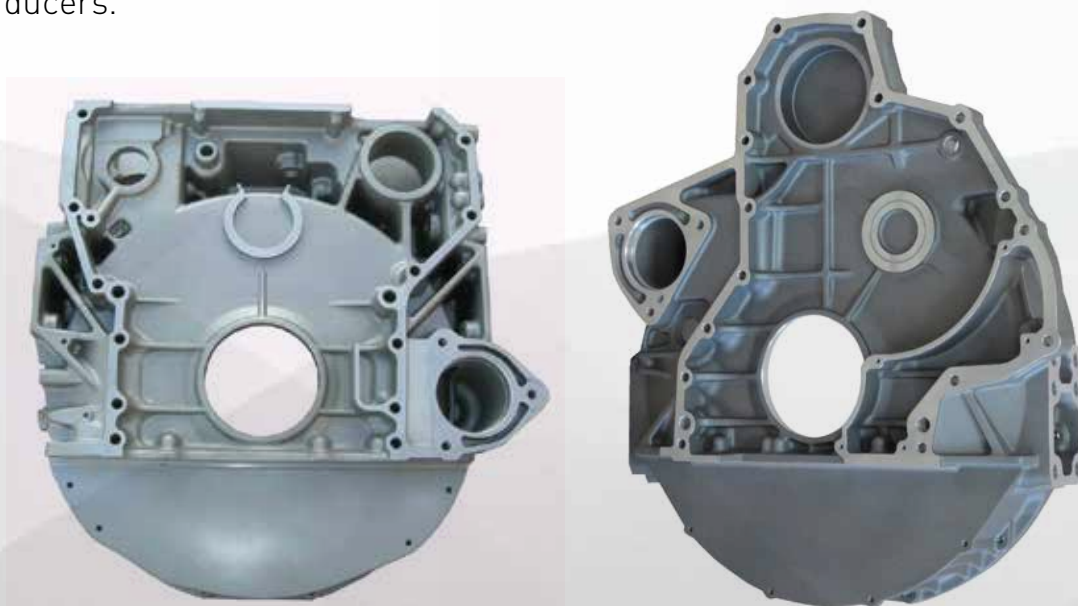



OIL COOLER

One of the critical parts for the engine; oil coolers we supply are all branded and tested products and also OEM. BF, OE, FEBI and DT are alternatives.

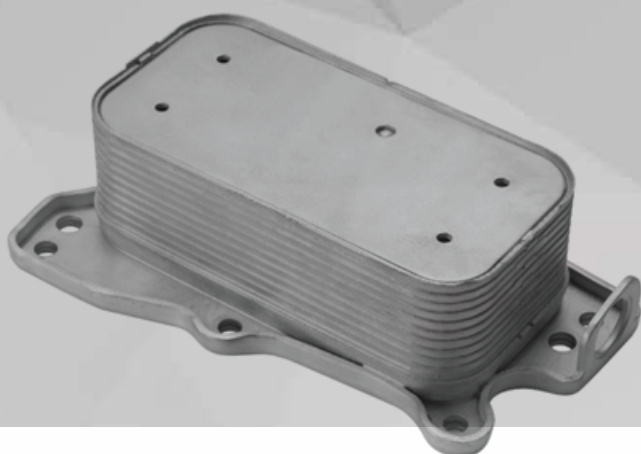
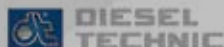

OIL COOLER, FILTER HOUSING

The aluminium castings of Housings are made by the standards of ISO16949 and after a serious strict quality controlling process offered to the market by the producers.





OIL PUMP

We prefer to supply OEM brands for Oil Pumps. LASO, LUK, RELO are almost the Original Equipment Manufacturers of all European Trucks and Buses.



WATER PUMP

We supply waterpumps which are Oem & Oes and for MAN, Mercedes Benz, Volvo, Scania, Daf, Iveco and RVI vehicles. We are authorized dealer in more than 20 countries around the world. We can supply also Sachs and Relo.





COMPRESSOR & PARTS

Our compressors and compressor parts are produced in a 80.000 m2 facility and by high technology. At the same time, we can supply compressor block, piston and forge crankshafts. Yumak and Wabco Brands are also alternatives in our Stocks.



PISTON, LINER, RING and CONNECTION ROD

For the most moving parts of the engines, we just supply Best and very well-known brands of the world. NURAL, MAHLE and GLYCO for EU Trucks and Buses are %90 in stock ready.





STARTERS

Starters and Starter Replacement Parts we supply are almost original or Best quality replacement parts. We also can offer BOSCH as an alternative.



ALTERNATORS

Alternators & Replacement Parts we supply are almost original or Best quality replacement parts. We also can offer BOSCH as an alternative.





BELT / BELT PULLEYS

We are officially supplier for OPTIBELT, BANDO, DAYCO and CONTI. Our Company is keeping stock for the most demanded Belts and Pulleys for EU Trucks and Buses. We can also supply ASSIST branded high quality bearings of Pulleys.





GASKETS & GASKET SETS

We supply products of ideal suppliers for professional engine repairs. Assist, Victor Reinz, Goetze and Elring can provide a comprehensive range of gasket sets, gaskets and sealing compounds to suit all market requirements.





RADIATORS & INTERCOOLERS

We offer an extensive range of products; a wide variety of OEM, supplied to light & heavy duty commercial vehicle manufacturers of especially EU Trucks and Buses.





SILICON HOSES

On Our silicon products it is easy to notice the quality. Our Products are offering experience for reliability and efficiency. The uncompromised fact is that first class raw materials are used for our Silicon products.





DRIVETRAIN

- Clutch Discs
- Clutch Covers
- Clutch Bearings
- Clutch Sets
- Clutch Repair Kits
- Clutch Master Cylinders
- Transmission
- Transmission Gears
- Differential Parts
- Propeller Shaft
- Shaft Bearings
- Shaft Spiders







CLUTCH DISCS

We supply clutches, clutch cover assemblies, discs at diameter of 215 mm-430 mm and release bearings for light and heavy duty commercial vehicles; such as Mercedes, Man, Daf, Volvo, Scania.



CLUTCH COVERS

We supply clutches, clutch cover assemblies, discs at diameter of 215 mm-430 mm and release bearings for light and heavy duty commercial vehicles; such as Mercedes, Man, Daf, Volvo, Scania.





CLUTCH BEARINGS

We supply clutches, clutch cover assemblies, discs at diameter of 215 mm-430 mm and release bearings for light and heavy duty commercial vehicles; such as Mercedes, Man, Daf, Volvo, Scania.



CLUTCH SETS

We supply clutches, clutch cover assemblies, discs at diameter of 215 mm-430 mm and release bearings for light and heavy duty commercial vehicles; such as Mercedes, Man, Daf, Volvo, Scania.





CLUTCH REPAIR KITS

We supply many clutch replacement parts for EU heavy duty vehicles starting with MB first than MAN and SCANIA.



CLUTCH MASTER CYLINDERS

Our clutch systems and components are distinguished by the fact that they require very little installation space, are light, and are very efficient.





TRANSMISSION

We supply original Full Transmissions with the Warranty of both MB and MAN.



TRANSMISSION GEARS

Our range includes every type of component used in gear and differential transmissions from the main industrial vehicle and engine manufacturers. In the last few years we have developed production batches for complete groups.





DIFFERENTIAL PARTS

Our range includes every type of component used in gear and differential transmissions from the main industrial vehicle and engine manufacturers. In the last few years we have developed production batches for complete groups.



PROPELLER SHAFT

Our suppliers are specialized in the design and manufacture of Propeller Shafts, Gear Box/Differential Flanges with over 60 years of experience in the automotive industry. All these product groups in Turkey and many more worldwide OEM and OES companies.





SHAFT BEARINGS

Our suppliers are specialized in the design and manufacture of Propeller Shafts, Gear Box/Differential Flanges with over 60 years of experience in the automotive industry. All these product groups in Turkey and many more worldwide OEM and OES companies.



SHAFT SPIDERS

Our suppliers are specialized in the design and manufacture of Propeller Shafts, Gear Box/Differential Flanges with over 60 years of experience in the automotive industry. All these product groups in Turkey and many more worldwide OEM and OES companies.



BRAKES

- Brake Cylinder
- Brake Valve
- Slack Adjuster
- Brake Discs
- Brake Caliper Repair Kits
- Brake Pads
- Retarder Repair Kit
- Retarder Oil Cooling





NIA

299

R 62



BRAKE CYLINDER

We supply the world's leading manufacturers of braking and control systems for commercial vehicles who also supplies all the world's leading commercial vehicle manufacturers.



BRAKE VALVE

We supply the world's leading manufacturers of braking and control systems for commercial vehicles who also supplies all the world's leading commercial vehicle manufacturers.





SLACK ADJUSTER

Slack Adjusters we supply are produced by the factories that develop and provide reliable and innovative solutions that improve safety, vehicle dynamics and environmental sustainability in the global commercial vehicle industry.



BRAKE DISCS & DRUM

High-tech brake drum and brake disc production facilities and Total Quality Concepts have established well-known brands like EKV, FRENBU and PIRLANTA. EKV is also the original equipment (OEM) and replacement part.

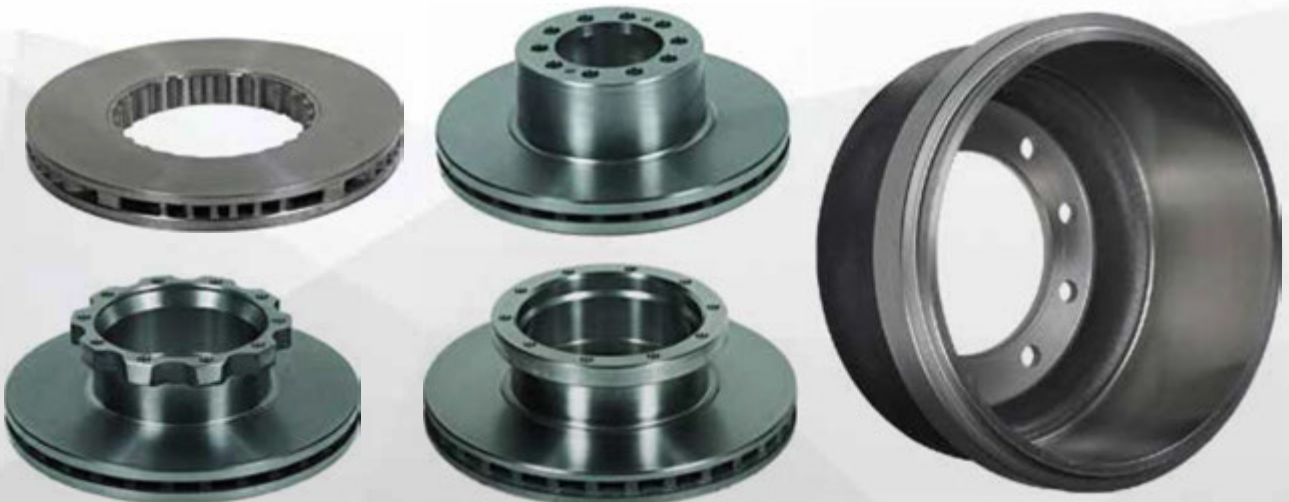



BRAKE PADS



The productions of drum brake linings are compatible with international standards and SAE 661 regulations. In addition to SAE 661 standards, ECR 90 regulations are respected during the production of disc brake pad. We offer our customers many alternative brands.



RETARDER REPAIR KIT

Retarder brake systems ensure optimum drive and efficient delay in busses and trucks and thus, ultimately far greater efficiency. We supply the replacement parts that fits like original.



RETARDER OIL COOLING

Retarder brake systems ensure optimum drive and efficient delay in busses and trucks and thus, ultimately far greater efficiency. We supply the replacement parts that fits like original.





CHASSIS

- Air Suspension
- Shock Absorber
- Level Adjustment Valves
- Stabilization
- Axle Beam
- Wheel Hub
- Wheel Cover
- Wheel Nuts
- Splash Guards







AIR SUSPENSION

We present you air spring in thanks to our mutual trade with the factory which is also supplier of many brands like Saffholland, Europart and PE. You are the most welcomed to visit our sister company's factory.



SHOCK ABSORBER

Our Shock Absorber product range consists of an extensive portfolio of shock absorbers for light commercial vehicles, buses and heavy trucks. We supply the shock absorbers which are also original equipments.





LEVEL ADJUSTMENT VALVES

We supply the world's leading manufacturers of air valve systems for commercial vehicles who also supplies all the world's leading commercial vehicle manufacturers.



STABILIZATION

We supply the world's leading manufacturers of air valve systems for commercial vehicles who also supplies all the world's leading commercial vehicle manufacturers.





AXLE BEAM

We supply profile chassis, air spring holding traverse, piston ,bottom bowl ,piston coat and roll plate which belongs buses, truck and trailers.



WHEEL HUB

Our wheel hub products are subjected to demanding criteria and testing before being shipped. This ensures consistent quality products that function exactly to your specifications.





WHEEL COVER

We supply metal, plastic wheel covers and their accessories for any type of bus, truck, TIR and commercial vehicles. Our factories are modernized with high tonnage hydraulic presses, eccentric presses, CNC milling cutter and universal lathe and allows to supply big orders in a short time.





WHEEL NUTS

Brands we offer to our customers holds the quality certificates ISO 9002, QS 9000, ISO/TS 16949 and ISO 14001. Today, our suppliers export to 36 countries and is market share leader in Turkey in heavy equipment nuts and bolts.



SPLASH GUARDS

We supply Mud/Splash Guards for Buses and Trucks and also special sized orders and printed products.





STEERING

- Power Steering
- Steering Pump
- Power Steering Equipment
- Steering Wheel





Mercedes-Benz

CARRIER

CNY 9641



POWER STEERING

The brand we supply provides the independent spare parts market with steering technology for commercial vehicles in original equipment quality. We also supply original Steering Equipments for especially MAN and MB.



STEERING PUMP

The brand we supply provides the independent spare parts market with steering technology for commercial vehicles in original equipment quality. We also supply original Steering Equipments for especially MAN and MB.





POWER STEERING EQUIPMENT

Brands we offer are the leading manufacturers & exporters of steering and suspension parts for the automotive after market industry. They have also started OEM activities.



STEERING WHEEL

We supply original steering wheels for almost all EU Trucks and Buses.



LIGHTING SYSTEM

- Front Lamp Units
- Rear Lamp Units
- Side Marker Lamps
- Position Lamps
- Interior Illumination
- Switches







FRONT LAMP UNITS

We offer almost all well-known brands of the world and also OEM Products.





REAR LAMP UNITS

We offer almost all well-known brands of the world and also OEM Products.





SIDE MARKER LAMPS

We offer almost all well-known brands of the world and also OEM Products.





POSITION LAMPS

We offer almost all well-known brands of the world and also OEM Products.





INTERIOR ILLUMINATION

We offer almost all well-known brands of the world and also OEM Products. In addition we also keep always stock of interior lightings used for designing and more illumination needed by the customer.



SWITCHES

For providing the quality and minimize the complaints, we just supply original switches for the demanded truck and bus brands.





BODY & FRAME

- Front Bumper
- Rear Bumper
- Hood & Flap
- Fender
- Door
- Paneling
- Lock & Locking Mechanism
- Gas Springs
- Extra Baggage
- Accessories







FRONT BUMPER

We supply body parts of the commercial vehicle bumpers, fenders, roller shutters, doors from metal and polsyester raw materials. According to the customer demands we also supply original body parts.



REAR BUMPER

We supply body parts of the commercial vehicle bumpers, fenders, roller shutters, doors from metal and polsyester raw materials. According to the customer demands we also supply original body parts.





HOOD & FLAP

We offer hoods and flaps of the commercial vehicles both aftermarket or original made of metal and polsyester materials.



FENDER

We can supply fenders of the commercial vehicles both aftermarket or original made of metal and polsyester materials.



DOOR

The doors of the commercial vehicles both aftermarket or original made of metal and polsyester materials are also available in out stocks.





PANELING

All the panellings and linings of the buses can be purchased directly from our dynamic stocks.





LOCK & LOCKING MECHANISM

Every kind of locks, cam locks, locking mechanisms and handles are available for sale and %90 percent of MB bus types are available in our stocks for fast deliveries.





GAS SPRINGS

We are pleased to provide our clients with wide range of high quality products, prompt service at competitive price. In addition to our standard product range, we are able to design and produce gas springs and end fittings according to the customers specific requirements. Our technical and sales team work together with the customer from the first design of the product to the final assembly stage in order to get the best result on the application area.





EXTRA BAGGAGE

For extra space we supply extra baggages for minibuses and also buses.



ACCESSORIES

Mahogany covers, top windows, emergency exits, wind stoppers and many other accessories are available.



VISIBILITY

- Windshield
- Window Regulator
- Side Windows
- Rear Window
- Outside Mirror
- Inside Rearview Mirror
- Mirror Replacements
- Wiping / Washing







WINDSHIELD

Ongul presents you DUBLEKS GLASS registered company's quality products for both buses and trucks.

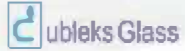

WINDOW REGULATOR

We offer our customers OEM products for window mechanisms.





SIDE WINDOWS

Ongul presents you DUBLEKS GLASS registered company's quality products for both buses and trucks.

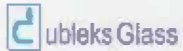

REAR WINDOW

Ongul presents you DUBLEKS GLASS registered company's quality products for both buses and trucks.





OUTSIDE MIRROR

Ongul presents you MEKRA best quality OEM mirror products with widest range.





INSIDE REARVIEW MIRROR

Ongul presents you MEKRA and MOTAYSAN best quality OEM mirror products with widest range.





MIRROR REPLACEMENTS

Ongul presents you MEKRA and MOTAYSAN best quality OEM mirror products with widest range.



WIPING / WASHING

The wiping and washing systems we supply are the market leader brand in Turkey aftermarket and also OEM of all Turkish bus and truck factories. Quality is always guaranteed by SKS.





HEATING & VENTILATION

- Blower Motor
- Axial Fans
- Ac Compressor
- Ac Systems Aircold
- Heating
- Propeller





BLOWER MOTOR

We are official distributor of Turkish Brand KORMAS which is the leading company in domestic aftermarket and Turkish OEM companies such as Mercedes Benz, MAN, Isuzu, Otoyol, Otokar, Temsa, BMC, Chrysler, Peugeot/Karsan for their commercial vehicles. We also supply SPAL Europe according to customer demands.





AXIEL FAN

We are official distributor of Turkish Brand KORMAS which is the leading company in domestic aftermarket and Turkish OEM companies such as Mercedes Benz, MAN, Isuzu, Otoyol, Otokar, Temsa, BMC, Chrysler, Peugeot/Karsan for their commercial vehicles. We also supply SPAL Europe according to customer demands.





AC COMPRESSOR

We are presenting our customers the best quality AC compressor parts under our own Brand ASSIST. We can also supply brand new Compressors BOCK and BITZER.





AC SYSTEMS AIRCOLD

AIRCOLD was established in 2008 and is one of the leading automotive air-conditioning & transport refrigeration manufactured with a quality reputation. All of our products should be easy to install on your vehicles.





HEATING

We are official distributor of Turkish Brand KORMAS which is the leading company in domestic aftermarket and Turkish OEM companies such as Mercedes Benz, MAN, Isuzu, Otoyol, Otokar, Temsa, BMC, Chrysler, Peugeot/Karsan for their commercial vehicles.

KORMAS
KARAYOLU KAMION VE TRAKTORLAR İÇİN





PROPELLER

We are official distributor of Turkish Brand KORMAS which is the leading company in domestic aftermarket and Turkish OEM companies such as Mercedes Benz, MAN, Isuzu, Otoyol, Otokar, Temsa, BMC, Chrysler, Peugeot/Karsan for their commercial vehicles.





INTERIOR EQUIPMENT

- Instrument Panel
- Passenger Seat Parts
- Passenger Seats
- Floor Covering
- Headrest Covers
- Roller Blinds
- Curtains
- Partition Panels
- Refrigerator Units
- Kitchen Units
- Torpedo refrigerators

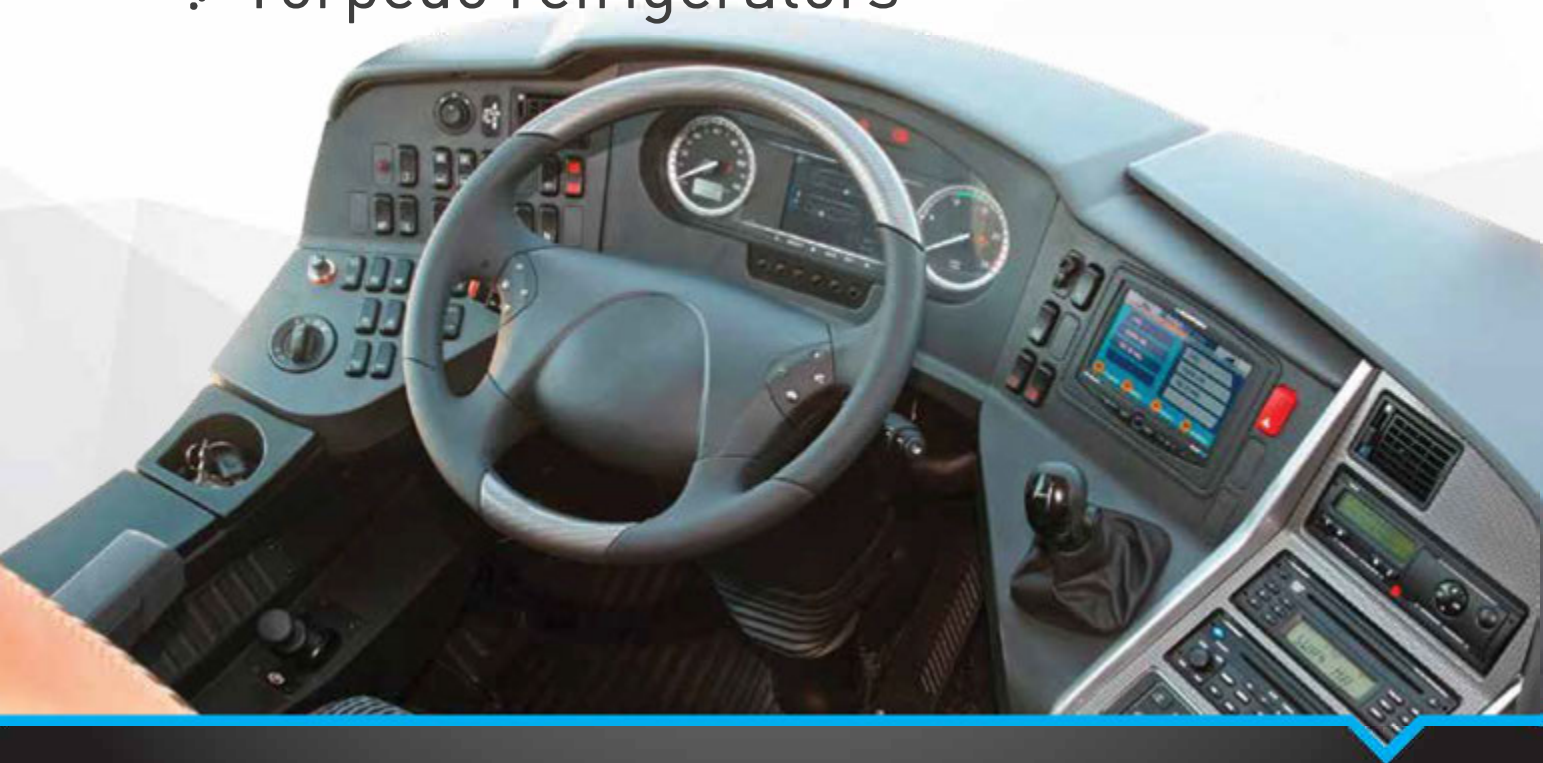





INSTRUMENT PANEL

The instrument panels we supply are produced in a 12000m² closed area; and advanced technology machinery. The products are developed after PD studies and are original equipments of the leading companies of Automotive industry like Mercedes Benz, MAN, Volvo, Ford Otosan, Otokar, Temsa, VDL, Solaris, Vanhool and many other factories.





PASSENGER SEAT PARTS

We have been a supplier for every kind of bus seat parts for longer than 20 years with best fitting quality proven OEM products.





PASSENGER SEATS

Our Bus Seats Factory has all certificates and accreditations according to European regulations are ECE R 14, ECE R 17, and ECE R 80 for M2/M3 type seats and also has M1 R14 seat certificates with fix and folding system on our quality wall along with ISO 9001 quality management system.







FLOOR COVERING

The Floor Covers are all consist of Original Products manufactured by OEM and OES companies.

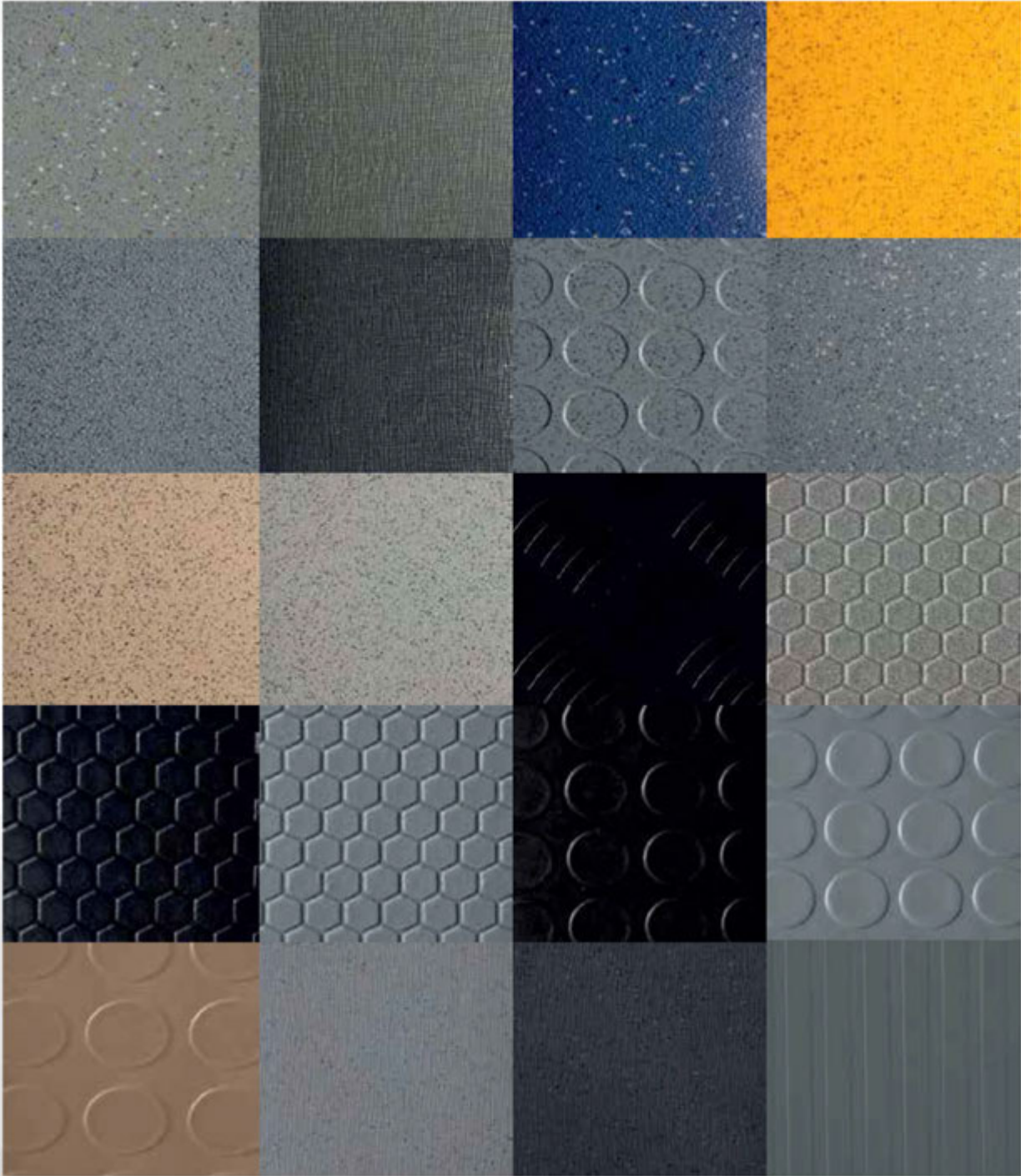



HEADREST COVERS

Headrest Covers are all produced by the textile factories which are specialist about the Bus Seats. We also accept the special color or fabric orders demanded by the customer.



ROLLER BLINDS

The roller Blinds are all consist of Original Products manufactured by OEM and OES companies.





CURTAINS

Bus curtains we supply are all produced by the textile factories which are specialist about the Buses. We also accept the special color or fabric orders demanded by the customer.



PARTITION PANELS

The instrument panels we supply are produced in a 12000m² closed area; and advanced technology machinery. The products are developed after PD studies and are original equipments of the leading companies of Automotive industry like Mercedes Benz, MAN, Volvo, Ford Otosan, Otokar, Temsa, VDL, Solaris, Vanhool and many other factories.







REFRIGERATOR UNITS

Our Refrigerators are all OEM products STARCOOL Brand preferred by almost all EU Coach bus and Minibus Factories.





KITCHEN UNITS

Our Kitchen Units are all OEM products STARCOOL Brand preferred by almost all EU Coach bus and Minibus Factories.





TORPEDO REFRIGERATORS

Our Refrigerators are all OEM products STARCOOL Brand preferred by almost all EU Coach bus and Minibus Factories.





ELECTRONICS

- Converter / Inverters
- Amplifier / Microphones
- Ballast
- Relay Units
- Sender Units







CONVERTER / INVERTERS



AMPLIFIER / MICROPHONES





BALLAST



RELAY UNITS





SENDER UNITS

The sender units of all EU trucks and buses are available as Original or First quality after market products.







Design Parts

Truck Spare Parts



New Models



QUALITY REPLACEMENT PARTS

DortRenk Turizm Gayr.Mot.Tas.San.Tic.Ltd.Sti.

İkitelli OSB Dolapdere San Sit 12 Ada No:56 Basakşehir / İstanbul/ Türkiye

info@busspares.com - info@dortrenkgrup.com

P:+90 212 243 02 03 F:+90 212 355 02 42 M:+90 532 746 23 78 (Whatsapp - Viber)